

Introduction to Linux

A Hands on Guide

Machtelt Garrels

CoreSequence.com

<tille@coresequence.com>

Version 1.11 20040202 Edition

Copyright © 2002, 2003, 2004 Machtelt Garrels

First published December 2002

Table of Contents

Introduction	1
<u>1. Why this guide?</u>	1
<u>2. Who should read this book?</u>	1
<u>3. New versions of this guide</u>	1
<u>4. Revision History</u>	1
<u>5. Contributions</u>	2
<u>6. Feedback</u>	3
<u>7. Copyright information</u>	3
<u>8. What do you need?</u>	3
<u>9. Conventions used in this document</u>	4
<u>10. Organization of this document</u>	5
Chapter 1. What is Linux?	6
<u>1.1. History</u>	6
<u>1.1.1. UNIX</u>	6
<u>1.1.2. Linus and Linux</u>	7
<u>1.1.3. Current application of Linux systems</u>	8
<u>1.2. The user interface</u>	8
<u>1.2.1. Is Linux difficult?</u>	8
<u>1.2.2. Linux for non-experienced users</u>	9
<u>1.3. Does Linux have a future?</u>	9
<u>1.3.1. Open Source</u>	9
<u>1.3.2. Ten years of experience at your service</u>	10
<u>1.4. Properties of Linux</u>	11
<u>1.4.1. Linux Pros</u>	11
<u>1.4.2. Linux Cons</u>	12
<u>1.5. Linux Flavors</u>	13
<u>1.5.1. Linux and GNU</u>	13
<u>1.5.2. GNU/Linux</u>	14
<u>1.5.3. Which distribution should I install?</u>	14
<u>1.6. Summary</u>	15
<u>1.7. Exercises</u>	15
Chapter 2. Quickstart	17
<u>2.1. Logging in, activating the user interface and logging out</u>	17
<u>2.1.1. Introduction</u>	17
<u>2.1.2. Graphical mode</u>	17
<u>2.1.3. Text mode</u>	19
<u>2.2. Absolute basics</u>	19
<u>2.2.1. The commands</u>	19
<u>2.2.2. General remarks</u>	20
<u>2.2.3. Using Bash features</u>	21
<u>2.3. Getting help</u>	22
<u>2.3.1. Be warned</u>	22
<u>2.3.2. The man pages</u>	22
<u>2.3.3. More info</u>	24
<u>2.4. Summary</u>	27
<u>2.5. Exercises</u>	27

Table of Contents

Chapter 2. Quickstart	
<u>2.5.1. Connecting and disconnecting</u>	28
<u>2.5.2. Passwords</u>	28
<u>2.5.3. Directories</u>	28
<u>2.5.4. Files</u>	29
<u>2.5.5. Getting help</u>	29
Chapter 3. About files and the file system	30
<u>3.1. General overview of the Linux file system</u>	30
<u>3.1.1. Files</u>	30
<u>3.1.2. About partitioning</u>	31
<u>3.1.3. More file system layout</u>	34
<u>3.2. Orientation in the file system</u>	37
<u>3.2.1. The path</u>	37
<u>3.2.2. Absolute and relative paths</u>	39
<u>3.2.3. The most important files and directories</u>	39
<u>3.2.4. The most important configuration files</u>	42
<u>3.2.5. The most common devices</u>	44
<u>3.2.6. The most common variable files</u>	45
<u>3.3. Manipulating files</u>	46
<u>3.3.1. Viewing file properties</u>	46
<u>3.3.2. Creating and deleting files and directories</u>	48
<u>3.3.3. Finding files</u>	52
<u>3.3.4. More ways to view file content</u>	56
<u>3.3.5. Linking files</u>	57
<u>3.4. File security</u>	59
<u>3.4.1. Access rights: Linux's first line of defense</u>	59
<u>3.4.2. The tools</u>	61
<u>3.5. Summary</u>	64
<u>3.6. Exercises</u>	66
<u>3.6.1. Partitions</u>	66
<u>3.6.2. Paths</u>	66
<u>3.6.3. Tour of the system</u>	66
<u>3.6.4. Manipulating files</u>	67
<u>3.6.5. File permissions</u>	67
Chapter 4. Processes	68
<u>4.1. Processes inside out</u>	68
<u>4.1.1. Multi-user and multi-tasking</u>	68
<u>4.1.2. Process types</u>	68
<u>4.1.3. Process attributes</u>	70
<u>4.1.4. Displaying process information</u>	71
<u>4.1.5. Life and death of a process</u>	73
<u>4.1.6. SUID and SGID</u>	75
<u>4.2. Boot process, Init and shutdown</u>	76
<u>4.2.1. Introduction</u>	76
<u>4.2.2. The boot process</u>	77
<u>4.2.3. GRUB features</u>	77

Table of Contents

Chapter 4. Processes	
4.2.4. Init	78
4.2.5. Init run levels	79
4.2.6. Shutdown	81
4.3. Managing processes	81
4.3.1. Work for the system admin	81
4.3.2. How long does it take?	82
4.3.3. Performance	83
4.3.4. Load	83
4.3.5. Can I do anything as a user?	83
4.4. Scheduling processes	86
4.4.1. Use that idle time!	87
4.4.2. The sleep command	87
4.4.3. The at command	87
4.4.4. Cron and crontab	88
4.5. Summary	90
4.6. Exercises	91
4.6.1. General	91
4.6.2. Booting, init etc.	91
4.6.3. Scheduling	92
Chapter 5. I/O redirection	93
5.1. What are standard input and standard output?	93
5.1.1. The redirection operators	93
5.1.2. Advanced redirection features	96
5.1.3. Filters	97
5.2. Summary	98
5.3. Exercises	98
Chapter 6. Text editors	99
6.1. Text editors	99
6.1.1. Why should I use an editor?	99
6.1.2. Which editor should I use?	99
6.2. Using the Vim editor	101
6.2.1. Two modes	101
6.2.2. Basic commands	101
6.2.3. The easy way	102
6.3. Linux in the office	102
6.3.1. History	102
6.3.2. Suites and programs	103
6.3.3. Remarks	103
6.4. Summary	104
6.5. Exercises	104
Chapter 7. Home sweet /home	105
7.1. General good housekeeping	105
7.1.1. Introduction	105
7.1.2. Make space	105

Table of Contents

Chapter 7. Home sweet /home	
7.2. <u>Your text environment</u>	108
7.2.1. <u>Environment variables</u>	108
7.2.2. <u>Shell setup files</u>	110
7.2.3. <u>A typical set of setup files</u>	111
7.2.4. <u>The Bash prompt</u>	114
7.2.5. <u>Shell scripts</u>	115
7.3. <u>The graphical environment</u>	117
7.3.1. <u>Introduction</u>	118
7.3.2. <u>The X Window System</u>	118
7.3.3. <u>X server configuration</u>	120
7.4. <u>Sound and video</u>	120
7.4.1. <u>Sound card configuration</u>	120
7.4.2. <u>If automatic sound card detection fails</u>	120
7.4.3. <u>Sound and video playing</u>	121
7.5. <u>Region specific settings</u>	123
7.5.1. <u>Keyboard setup</u>	123
7.5.2. <u>Fonts</u>	124
7.5.3. <u>Time zone</u>	124
7.5.4. <u>Language</u>	124
7.5.5. <u>Specific information for Belgium</u>	125
7.5.6. <u>Other countries</u>	125
7.6. <u>Installing new software</u>	125
7.6.1. <u>General</u>	125
7.6.2. <u>Package formats</u>	125
7.6.3. <u>Automating package management and updates</u>	127
7.6.4. <u>Upgrading your kernel</u>	129
7.6.5. <u>Installing extra packages from the installation CDs</u>	130
7.7. <u>Summary</u>	131
7.8. <u>Exercises</u>	131
7.8.1. <u>Shell environment</u>	131
7.8.2. <u>Graphical environment</u>	131
Chapter 8. Printers and printing	133
8.1. <u>Printing files</u>	133
8.1.1. <u>General</u>	133
8.1.2. <u>Formatting</u>	134
8.2. <u>The server side</u>	135
8.2.1. <u>General</u>	135
8.2.2. <u>Graphical printer configuration</u>	135
8.2.3. <u>Buying a printer for Linux</u>	135
8.3. <u>Print problems</u>	136
8.3.1. <u>Wrong file</u>	136
8.3.2. <u>My print hasn't come out</u>	136
8.4. <u>Summary</u>	138
8.5. <u>Exercises</u>	138

Table of Contents

Chapter 9. Fundamental Backup Techniques	139
<u>9.1. Introduction</u>	139
9.1.1. Preparing your data.....	139
9.2. Moving your data to a backup device.....	143
9.2.1. Making a copy on a floppy disk.....	143
9.2.2. Making a copy with a CD-writer.....	145
9.2.3. Backups on/from jazz drives, USB devices and such.....	146
9.2.4. Backing up data using a tape device.....	147
9.2.5. Tools from your distribution.....	147
9.3. Summary.....	147
9.4. Exercises.....	148
Chapter 10. Networking	149
10.1. Networking Overview.....	149
10.1.1. Networking protocols.....	149
10.1.2. Network configuration and information.....	151
10.2. Internet/Intranet applications.....	156
10.2.1. Server types.....	156
10.2.2. Mail.....	158
10.2.3. Web.....	160
10.2.4. File Transfer Protocol.....	160
10.2.5. Chatting and conferencing.....	161
10.2.6. News services.....	162
10.2.7. The Domain Name System.....	162
10.2.8. DHCP.....	163
10.2.9. Authentication services.....	163
10.3. Remote execution of applications.....	165
10.3.1. Introduction.....	165
10.3.2. Rsh, rlogin and telnet.....	165
10.3.3. The X Window System.....	166
10.3.4. The SSH suite.....	167
10.3.5. VNC.....	171
10.4. Security.....	171
10.4.1. Introduction.....	171
10.4.2. Services.....	171
10.4.3. Update regularly.....	172
10.4.4. Firewalls and access policies.....	172
10.4.5. Intrusion detection.....	174
10.4.6. More tips.....	174
10.4.7. Have I been hacked?.....	175
10.4.8. Recovering from intrusion.....	175
10.5. Summary.....	175
10.6. Exercises.....	176
10.6.1. General networking.....	176
10.6.2. Remote connections.....	176
10.6.3. Security.....	176

Table of Contents

<u>Appendix A. Where to go from here?</u>	177
<u>A.1. Useful Books</u>	177
<u>A.1.1. General Linux</u>	177
<u>A.1.2. Editors</u>	177
<u>A.1.3. Shells</u>	177
<u>A.1.4. X Windows</u>	177
<u>A.1.5. Networking</u>	178
<u>A.2. Useful sites</u>	178
<u>A.2.1. General information</u>	178
<u>A.2.2. Architecture Specific References</u>	178
<u>A.2.3. Distributions</u>	178
<u>A.2.4. Software</u>	179
<u>Appendix B. DOS versus Linux commands</u>	180
<u>Appendix C. Shell Features</u>	181
<u>C.1. Common features</u>	181
<u>C.2. Differing features</u>	182
<u>Appendix D. GNU Free Documentation License</u>	185
<u>D.1. Preamble</u>	185
<u>D.2. Applicability and definitions</u>	185
<u>D.3. Verbatim copying</u>	186
<u>D.4. Copying in quantity</u>	186
<u>D.5. Modifications</u>	187
<u>D.6. Combining documents</u>	188
<u>D.7. Collections of documents</u>	188
<u>D.8. Aggregation with independent works</u>	189
<u>D.9. Translation</u>	189
<u>D.10. Termination</u>	189
<u>D.11. Future revisions of this license</u>	189
<u>D.12. How to use this License for your documents</u>	190
<u>Appendix E. proc.txt</u>	191
<u>E.1. The /proc Filesystem</u>	191
<u>Glossary</u>	221
<u>A</u>	221
<u>B</u>	221
<u>C</u>	221
<u>D</u>	222
<u>E</u>	223
<u>F</u>	223
<u>G</u>	223
<u>H</u>	224
<u>I</u>	224
<u>J</u>	224
<u>K</u>	225

Table of Contents

Glossary

<u>L</u>	225
<u>M</u>	226
<u>N</u>	226
<u>P</u>	227
<u>Q</u>	227
<u>R</u>	227
<u>S</u>	228
<u>T</u>	228
<u>U</u>	229
<u>V</u>	229
<u>W</u>	230
<u>X</u>	230
<u>Z</u>	231

Introduction

1. Why this guide?

Many people still believe that learning Linux is difficult, or that only experts can understand how a Linux system works. Though there is a lot of free documentation available, the documentation is widely scattered on the Web, and often confusing, since it is usually oriented toward experienced UNIX or Linux users. Today, thanks to the advancements in development, Linux has grown in popularity both at home and at work. The goal of this guide is to show people of all ages that Linux can be simple and fun, and used for all kinds of purposes.

2. Who should read this book?

This guide was created as an overview of the Linux Operating System, geared toward new users as an exploration tour and getting started guide, with exercises at the end of each chapter. For more advanced trainees it can be a desktop reference, and a collection of the base knowledge needed to proceed with system and network administration. This book contains many real life examples derived from the author's experience as a Linux system and network administrator, trainer and consultant. We hope these examples will help you to get a better understanding of the Linux system and that you feel encouraged to try out things on your own.

Everybody who wants to get a "CLUE", a Command Line User Experience, with Linux (and UNIX in general) will find this book useful.

3. New versions of this guide

This document is published in the Guides section of the Linux Documentation Project collection at <http://www.tldp.org/guides.html>; you can also download PDF and PostScript formatted versions here for printing.

The most recent edition is available at <http://tille.soti.org/training/tldp/>.

4. Revision History

Revision History

Revision 1.11	2004-02-02	Revised by: MG
Completed bookinfo with ISBN		
Revision 1.10	2004-01-06	Revised by: MG
Changed encoding to UTF-8, rearranged revision history. Added a lot of markup in the screen sections to better distinguish prompts from commands; introduced warnings, cautions and tips.		
Revision 1.9	2003-11-29	Revised by: MG
Acted upon remarks from readers to clarify issues with compressed files, removable media; found a couple more spelling errors, added an extra example for cron and one for prompt settings; took out reference to Acrobat Reader and stufit, which are not Open Source (pointing to a fancy flight simulator instead ;-). More on keyboard layout. Added RPM example, added yum package manager.		
Revision 1.8	2003-09-16	Revised by: MG

German, Hindi and more. It is a big work that should not be underestimated; I admire your courage.

6. Feedback

Missing information, missing links, missing characters? Mail it to the maintainer of this document:

[<tille@coresequence.com>](mailto:tille@coresequence.com)

Don't forget to check with the [latest version](#) first!

7. Copyright information

© 2002–2004 Machtelt Garrels.

Permission is granted to copy, distribute and/or modify this document under the terms of the GNU Free Documentation License, Version 1.1 or any later version published by the Free Software Foundation; with the Invariant Sections being the "Copyright information" and "Feedback" sections, with no Front-Cover Texts and no Back-Cover Texts. A copy of the license is included in [Appendix D](#) entitled "GNU Free Documentation License".

Read [The GNU Manifesto](#) if you want to know why this license was chosen for this book.

The author and publisher have made every effort in the preparation of this book to ensure the accuracy of the information. However, the information contained in this book is offered without warranty, either express or implied. Neither the author nor the publisher nor any dealer or distributor will be held liable for any damages caused or alleged to be caused either directly or indirectly by this book.

The logos, trademarks and symbols used in this book are the properties of their respective owners.

8. What do you need?

You will require a computer and a medium containing a Linux distribution. Most of this guide applies to all Linux distributions – and UNIX in general. Apart from time, there are no further specific requirements.

The [Installation HOWTO](#) contains helpful information on how to obtain Linux software and install it on your computer. Hardware requirements and coexistence with other operating systems are also discussed.

CD images can be downloaded from linux-iso.com and many other locations, see [Appendix A](#).

An interesting alternative for those who don't dare to take the step of an actual Linux installation on their machine are the Linux distributions that you can run from a CD, such as the [Knoppix](#) distribution.

9. Conventions used in this document

The following typographic and usage conventions occur in this text:

Table 1. Typographic and usage conventions

Text type	Meaning
"Quoted text"	Quotes from people, quoted computer output.
<code>terminal view</code>	Literal computer input and output captured from the terminal, usually rendered with a light grey background.
command	Name of a command that can be entered on the command line.
VARIABLE	Name of a variable or pointer to content of a variable, as in <code>\$VARIABLE</code> .
option	Option to a command, as in "the <code>-a</code> option to the <code>ls</code> command".
argument	Argument to a command, as in "read man <i>ls</i> ".
command options arguments	Command synopsis or general usage, on a separated line.
filename	Name of a file or directory, for example "Change to the <code>/usr/bin</code> directory."
Key	Keys to hit on the keyboard, such as "type Q to quit".
Button	Graphical button to click, like the OK button.
Menu->Choice	Choice to select from a graphical menu, for instance: "Select Help -> About Mozilla in your browser."
<i>Terminology</i>	Important term or concept: "The Linux <i>kernel</i> is the heart of the system."
<code>\</code>	The backslash in a terminal view or command synopsis indicates an unfinished line. In other words, if you see a long command that is cut into multiple lines, <code>\</code> means "Don't press Enter yet!"
See Chapter 1	link to related subject within this guide.
The author	Clickable link to an external web resource.

The following images are used:



This is a note

It contains additional information or remarks.



This is a caution

It means be careful.



This is a warning

Be *very* careful.



This is a tip

Tips and tricks.

10. Organization of this document

This guide aims to be the foundation for all other materials that you can get from The Linux Documentation Project. As such, it provides you with the fundamental knowledge needed by anyone who wants to start working with a Linux system, while at the same time it tries to consciously avoid to re-invent the hot water. Thus, you can expect this book to be incomplete and full of links to sources of additional information on your system, on the Internet and in your system documentation.

The first chapter is an introduction to the subject on Linux; the next two discuss absolute basic commands. Chapters 4 and 5 discuss some more advanced but still basic topics. Chapter 6 is needed for continuing with the rest, since it discusses editing files, an ability you need to pass from Linux newbie to Linux user. The following chapters discuss somewhat more advanced topics that you will have to deal with in everyday Linux use.

All chapters come with exercises that will test your preparedness for the next chapter.

- [Chapter 1](#): What is Linux, how did it come into existence, who should use it, installing your computer.
 - [Chapter 2](#): Getting started, connecting to the system, basic commands, where to find help.
 - [Chapter 3](#): The filesystem, important files and directories, managing files and directories, security modes.
 - [Chapter 4](#): Understanding and managing processes, boot and shutdown procedures, postponing tasks, repetitive tasks.
 - [Chapter 5](#): What are standard input, output and error and how are these features used from the command line.
 - [Chapter 6](#): Why you should learn to work with an editor, discussion of the most common editors.
 - [Chapter 7](#): Configuring your graphical, text and audio environment, settings for the non-native English speaking Linux user, tips for adding extra software.
 - [Chapter 8](#): Converting files to a printable format, getting them out of the printer, hints for solving print problems.
 - [Chapter 9](#): Preparing data to be backed up, discussion of various tools.
 - [Chapter 10](#): Overview of Linux networking tools and user applications, with a short discussion of the underlying service daemon programs and secure networking.
 - [Appendix A](#): Which books to read and sites to visit when you have finished reading this one.
 - [Appendix B](#): A comparison.
 - [Appendix C](#): If you ever get stuck, these tables might be an outcome. Also a good argument when your boss insists that YOU should use HIS favorite shell.
 - [Appendix D](#): What you can do with this guide, from the legal perspective.
-

Chapter 1. What is Linux?

We will start with an overview of how Linux became the operating system it is today. We will discuss past and future development and take a closer look at the advantages and disadvantages of this system. We will talk about distributions, about Open Source in general and try to explain a little something about GNU.

This chapter answers questions like:

- ◆ What is Linux?
 - ◆ Where and how did Linux start?
 - ◆ Isn't Linux that system where everything is done in text mode?
 - ◆ Does Linux have a future or is it just hype?
 - ◆ What are the advantages of using Linux?
 - ◆ What are the disadvantages?
 - ◆ What kinds of Linux are there and how do I choose the one that fits me?
 - ◆ What are the Open Source and GNU movements?
-

1.1. History

1.1.1. UNIX

In order to understand the popularity of Linux, we need to travel back in time, about 30 years ago...

Imagine computers as big as houses, even stadiums. While the sizes of those computers posed substantial problems, there was one thing that made this even worse: every computer had a different operating system. Software was always customized to serve a specific purpose, and software for one given system didn't run on another system. Being able to work with one system didn't automatically mean that you could work with another. It was difficult, both for the users and the system administrators.

Computers were extremely expensive then, and sacrifices had to be made even after the original purchase just to get the users to understand how they worked. The total cost of IT was enormous.

Technologically the world was not quite that advanced, so they had to live with the size for another decade. In 1969, a team of developers in the Bell Labs laboratories started working on a solution for the software problem, to address these compatibility issues. They developed a new operating system, which was

1. Simple and elegant.
2. Written in the C programming language instead of in assembly code.
3. Able to recycle code.

The Bell Labs developers named their project "UNIX."

The code recycling features were very important. Until then, all commercially available computer systems were written in a code specifically developed for one system. UNIX on the other hand needed only a small piece of that special code, which is now commonly named the kernel. This kernel is the only piece of code that needs to be adapted for every specific system and forms the base of the UNIX system. The operating system and all other functions were built around this kernel and written in a higher programming language, C.

Introduction to Linux

This language was especially developed for creating the UNIX system. Using this new technique, it was much easier to develop an operating system that could run on many different types of hardware.

The software vendors were quick to adapt, since they could sell ten times more software almost effortlessly. Weird new situations came in existence: imagine for instance computers from different vendors communicating in the same network, or users working on different systems without the need for extra education to use another computer. UNIX did a great deal to help users become compatible with different systems.

Throughout the next couple of decades the development of UNIX continued. More things became possible to do and more hardware and software vendors added support for UNIX to their products.

UNIX was initially found only in very large environments with mainframes and minicomputers (note that a PC is a "micro" computer). You had to work at a university, for the government or for large financial corporations in order to get your hands on a UNIX system.

But smaller computers were being developed, and by the end of the 80's, many people had home computers. By that time, there were several versions of UNIX available for the PC architecture, but none of them were truly free.

1.1.2. Linus and Linux

Linus Torvalds, a young man studying computer science at the university of Helsinki, thought it would be a good idea to have some sort of freely available academic version of UNIX, and promptly started to code.

He started to ask questions, looking for answers and solutions that would help him get UNIX on his PC. Below is one of his first posts in comp.os.minix, dating from 1991:

```
From: torvalds@klaava.Helsinki.FI (Linus Benedict Torvalds)
Newsgroups: comp.os.minix
Subject: Gcc-1.40 and a posix-question
Message-ID: <1991Jul3.100050.9886@klaava.Helsinki.FI>
Date: 3 Jul 91 10:00:50 GMT
Hello netlanders,
Due to a project I'm working on (in minix), I'm interested in the posix
standard definition. Could somebody please point me to a (preferably)
machine-readable format of the latest posix rules? Ftp-sites would be
nice.
```

From the start, it was Linus' goal to have a free system that was completely compliant with the original UNIX. That is why he asked for POSIX standards, POSIX still being the standard for UNIX.

In those days plug-and-play wasn't invented yet, but so many people were interested in having a UNIX system of their own, that this was only a small obstacle. New drivers became available for all kinds of new hardware, at a continuously rising speed. Almost as soon as a new piece of hardware became available, someone bought it and submitted it to the Linux test, as the system was gradually being called, releasing more free code for an ever wider range of hardware. These coders didn't stop at their PC's; every piece of hardware they could find was useful for Linux.

Back then, those people were called "nerds" or "freaks", but it didn't matter to them, as long as the supported hardware list grew longer and longer. Thanks to these people, Linux is now not only ideal to run on new PC's, but is also the system of choice for old and exotic hardware that would be useless if Linux didn't exist.

Two years after Linus' post, there were 12000 Linux users. The project, popular with hobbyists, grew steadily, all the while staying within the bounds of the POSIX standard. All the features of UNIX were added over the next couple of years, resulting in the mature operating system Linux has become today. Linux is a full UNIX clone, fit for use on workstations as well as on middle-range and high-end servers. Today, all the important players on the hard- and software market each have their team of Linux developers; at your local dealer's you can even buy pre-installed Linux systems with official support.

1.1.3. Current application of Linux systems

Today Linux has joined the desktop market. Linux developers concentrated on networking and services in the beginning, and office applications have been the last barrier to be taken down. We don't like to admit that Microsoft is ruling this market, so plenty of alternatives have been started over the last couple of years to make Linux an acceptable choice as a workstation, providing an easy user interface and MS compatible office applications like word processors, spreadsheets, presentations and the like.

On the server side, Linux is well-known as a stable and reliable platform, providing database and trading services for companies like Amazon, the well-known online bookshop, US Post Office, the German army and such. Especially Internet providers and Internet service providers have grown fond of Linux as firewall, proxy- and web server, and you will find a Linux box within reach of every UNIX system administrator who appreciates a comfortable management station. Clusters of Linux machines are used in the creation of movies such as "Titanic", "Shrek" and others. In post offices, they are the nerve centers that route mail and in large search engine, clusters are used to perform internet searches. These are only a few of the thousands of heavy-duty jobs that Linux is performing day-to-day across the world.

It is also worth to note that modern Linux not only runs on workstations, mid- and high-end servers, but also on "gadgets" like PDA's, mobiles, a shipload of embedded applications and even on experimental wristwatches. This makes Linux the only operating system in the world covering such a wide range of hardware.

1.2. The user interface

1.2.1. Is Linux difficult?

Whether Linux is difficult to learn depends on the person you're asking. Experienced UNIX users will say no, because Linux is an ideal operating system for power-users and programmers, because it has been and is being developed by such people.

Everything a good programmer can wish for is available: compilers, libraries, development and debugging tools. These packages come with every standard Linux distribution. The C-compiler is included for free, all the documentation and manuals are there, and examples are often included to help you get started in no time. It feels like UNIX and switching between UNIX and Linux is a natural thing.

In the early days of Linux, being an expert was kind of required to start using the system. Those who mastered Linux felt better than the rest of the "lusers" who hadn't seen the light yet. It was common practice to tell a beginning user to "RTFM" (read the manuals). While the manuals were on every system, it was difficult to find the documentation, and even if someone did, explanations were in such technical terms that the new user became easily discouraged from learning the system.

The Linux-using community started to realize that if Linux was ever to be an important player on the

operating system market, there had to be some serious changes in the accessibility of the system.

1.2.2. Linux for non-experienced users

Companies such as RedHat, SuSE and Mandrake have sprung up, providing packaged Linux distributions suitable for mass consumption. They integrated a great deal of graphical user interfaces (GUIs), developed by the community, in order to ease management of programs and services. As a Linux user today you have all the means of getting to know your system inside out, but it is no longer necessary to have that knowledge in order to make the system comply to your requests.

Nowadays you can log in graphically and start all required applications without even having to type a single character, while you still have the ability to access the core of the system if needed. Because of its structure, Linux allows a user to grow into the system: it equally fits new and experienced users. New users are not forced to do difficult things, while experienced users are not forced to work in the same way they did when they first started learning Linux.

While development in the service area continues, great things are being done for desktop users, generally considered as the group least likely to know how a system works. Developers of desktop applications are making incredible efforts to make the most beautiful desktops you've ever seen, or to make your Linux machine look just like your former MS Windows or MacIntosh workstation. The latest developments also include 3D acceleration support and support for USB devices, single-click updates of system and packages, and so on. Linux has these, and tries to present all available services in a logical form that ordinary people can understand. Below is a short list containing some great examples; these sites have a lot of screenshots that will give you a glimpse of what Linux on the desktop can be like:

- <http://ximian.com/products/desktop/screenshots.html>
 - <http://kde.org/screenshots/>
 - <http://www.codeweavers.com/products/office/>
-

1.3. Does Linux have a future?

1.3.1. Open Source

The idea behind Open Source software is rather simple: when programmers can read, distribute and change code, the code will mature. People can adapt it, fix it, debug it, and they can do it at a speed that dwarfs the performance of software developers at conventional companies. This software will be more flexible and of a better quality than software that has been developed using the conventional channels, because more people have tested it in more different conditions than the closed software developer ever can.

The Open Source initiative started to make this clear to the commercial world, and very slowly, commercial vendors are starting to see the point. While lots of academics and technical people have already been convinced for 20 years now that this is the way to go, commercial vendors needed applications like the Internet to make them realize they can profit from Open Source. Now Linux has grown past the stage where it was almost exclusively an academic system, useful only to a handful of people with a technical background. Now Linux provides more than the operating system: there is an entire infrastructure supporting the chain of effort of creating an operating system, of making and testing programs for it, of bringing everything to the users, of supplying maintenance, updates and support and customizations, etcetera. Today, Linux is ready to accept the challenge of a fast-changing world.

1.3.2. Ten years of experience at your service

While Linux is probably the most well-known Open Source initiative, there is another project that contributed enormously to the popularity of the Linux operating system. This project is called SAMBA, and its achievement is the reverse engineering of the Server Message Block (SMB)/Common Internet File System (CIFS) protocol used for file- and print-serving on PC-related machines, natively supported by MS Windows NT and OS/2, and Linux. Packages are now available for almost every system and provide interconnection solutions in mixed environments using MS Windows protocols: Windows-compatible (up to and including WinXP) file- and print-servers.

Maybe even more successful than the SAMBA project is the Apache HTTP server project. The server runs on UNIX, Windows NT and many other operating systems. Originally known as "A PAtCHy server", based on existing code and a series of "patch files", the name for the matured code deserves to be connoted with the native American tribe of the Apache, well-known for their superior skills in warfare strategy and inexhaustible endurance. Apache has been shown to be substantially faster, more stable and more feature-full than many other web servers. Apache is run on sites that get millions of visitors per day, and while no official support is provided by the developers, the Apache user community provides answers to all your questions. Commercial support is now being provided by a number of third parties.

In the category of office applications, a choice of MS Office suite clones is available, ranging from partial to full implementations of the applications available on MS Windows workstations. These initiatives helped a great deal to make Linux acceptable for the desktop market, because the users don't need extra training to learn how to work with new systems. With the desktop comes the praise of the common users, and not only their praise, but also their specific requirements, which are growing more intricate and demanding by the day.

The Open Source community, consisting largely of people who have been contributing for over half a decade, assures Linux' position as an important player on the desktop market as well as in general IT application. Paid employees and volunteers alike are working diligently so that Linux can maintain a position in the market. The more users, the more questions. The Open Source community makes sure answers keep coming, and watches the quality of the answers with a suspicious eye, resulting in ever more stability and accessibility.

Listing all the available Linux software is beyond the scope of this guide, as there are tens of thousands of packages. Throughout this course we will present you with the most common packages, which are almost all freely available. In order to take away some of the fear of the beginning user, here's a screenshot of one of your most-wanted programs. You can see for yourself that no effort has been spared to make users who are switching from Windows feel at home:

Figure 1-1. OpenOffice MS-compatible Spreadsheet

The screenshot shows an OpenOffice.org 1.0.1 spreadsheet window titled 'msedu.xls'. The spreadsheet contains a table with columns A through E. The data is as follows:

	A	B	C	D	E
2237	810-01438	SQL Svr Enterprise Edtn Italian Lic/SA MVL	3 Yr(s) Remaining	75	Servers
2238	810-01570	SQL Svr Enterprise Edtn Spanish SA MVL	2 Yr(s) Remaining	30	Servers
2239	810-01583	SQL Svr Enterprise Edtn Spanish SA MVL 1 Processor License	2 Yr(s) Remaining	125	Servers

The spreadsheet interface includes a menu bar (File, Edit, View, Insert, Format, Tools, Data, Window, Help), a toolbar, and a status bar at the bottom showing 'Sheet 1 / 3', 'TAB_Sheet1', '100%', 'STD', and 'Sum=0'.

1.4. Properties of Linux

1.4.1. Linux Pros

A lot of the advantages of Linux are a consequence of Linux' origins, deeply rooted in UNIX, except for the first advantage, of course:

- Linux is free:

As in free beer, they say. If you want to spend absolutely nothing, you don't even have to pay the price of a CD. Linux can be downloaded in its entirety from the Internet completely for free. No registration fees, no costs per user, free updates, and freely available source code in case you want to change the behavior of your system.

Most of all, Linux is free as in free speech:

The license commonly used is the GNU Public License (GPL). The license says that anybody who may want to do so, has the right to change Linux and eventually to redistribute a changed version, on the one condition that the code is still available after redistribution. In practice, you are free to grab a kernel image, for instance to add support for teletransportation machines or time travel and sell your new code, as long as your customers can still have a copy of that code.

- Linux is portable to any hardware platform:

A vendor who wants to sell a new type of computer and who doesn't know what kind of OS his new machine will run (say the CPU in your car or washing machine), can take a Linux kernel and make it

Introduction to Linux

work on his hardware, because documentation related to this activity is freely available.

- Linux was made to keep on running:

As with UNIX, a Linux system expects to run without rebooting all the time. That is why a lot of tasks are being executed at night or scheduled automatically for other calm moments, resulting in higher availability during busier periods and a more balanced use of the hardware. This property allows for Linux to be applicable also in environments where people don't have the time or the possibility to control their systems night and day.

- Linux is secure and versatile:

The security model used in Linux is based on the UNIX idea of security, which is known to be robust and of proven quality. But Linux is not only fit for use as a fort against enemy attacks from the Internet: it will adapt equally to other situations, utilizing the same high standards for security. Your development machine or control station will be as secure as your firewall.

- Linux is scalable:

From a Palmtop with 2 MB of memory to a petabyte storage cluster with hundreds of nodes: add or remove the appropriate packages and Linux fits all. You don't need a supercomputer anymore, because you can use Linux to do big things using the building blocks provided with the system. If you want to do little things, such as making an operating system for an embedded processor or just recycling your old 486, Linux will do that as well.

- The Linux OS and Linux applications have very short debug-times:

Because Linux has been developed and tested by thousands of people, both errors and people to fix them are found very quickly. It often happens that there are only a couple of hours between discovery and fixing of a bug.

1.4.2. Linux Cons

- There are far too many different distributions:

"Quot capites, tot rationes", as the Romans already said: the more people, the more opinions. At first glance, the amount of Linux distributions can be frightening, or ridiculous, depending on your point of view. But it also means that everyone will find what he or she needs. You don't need to be an expert to find a suitable release.

When asked, generally every Linux user will say that the best distribution is the specific version he is using. So which one should you choose? Don't worry too much about that: all releases contain more or less the same set of basic packages. On top of the basics, special third party software is added making, for example, TurboLinux more suitable for the small and medium enterprise, RedHat for servers and SuSE for workstations. However, the differences are likely to be very superficial. The best strategy is to test a couple of distributions; unfortunately not everybody has the time for this. Luckily, there is plenty of advice on the subject of choosing your Linux. One place is [LinuxJournal](#), which discusses hardware and support, among many other subjects. The [Installation HOWTO](#) also discusses choosing your distribution.

- Linux is not very user friendly and confusing for beginners:

In light of its popularity, considerable effort has been made to make Linux even easier to use, especially for new users. More information is being released daily, such as this guide, to help fill the gap for documentation available to users at all levels.

- Is an Open Source product trustworthy?

How can something that is free also be reliable? Linux users have the choice whether to use Linux or not, which gives them an enormous advantage compared to users of proprietary software, who don't have that kind of freedom. After long periods of testing, most Linux users come to the conclusion that Linux is not only as good, but in many cases better and faster than the traditional solutions. If Linux were not trustworthy, it would have been long gone, never knowing the popularity it has now, with millions of users. Now users can influence their systems and share their remarks with the community, so the system gets better and better every day. It is a project that is never finished, that is true, but in an ever changing environment, Linux is also a project that continues to strive for perfection.

1.5. Linux Flavors

1.5.1. Linux and GNU

Although there are a large number of Linux implementations, you will find a lot of similarities in the different distributions, if only because every Linux machine is a box with building blocks that you may put together following your own needs and views. Installing the system is only the beginning of a longterm relationship. Just when you think you have a nice running system, Linux will stimulate your imagination and creativeness, and the more you realize what power the system can give you, the more you will try to redefine its limits.

Linux may appear different depending on the distribution, your hardware and personal taste, but the fundamentals on which all graphical and other interfaces are built, remain the same. The Linux system is based on GNU tools (Gnu's Not UNIX), which provide a set of standard ways to handle and use the system. All GNU tools are open source, so they can be installed on any system. Most distributions offer pre-compiled packages of most common tools, such as RPM packages on RedHat and dpkg packages on Debian, so you needn't be a programmer to install a package on your system. However, if you are and like doing things yourself, you will enjoy Linux all the better, since most distributions come with a complete set of development tools, allowing installation of new software purely from source code. This setup also allows you to install software even if it does not exist in a pre-packaged form suitable for your system.

A list of common GNU software:

- Bash: The GNU shell
- GCC: The GNU C Compiler
- GDB: The GNU Debugger
- Findutils: to search and find files
- Fontutils: to convert fonts from one format to another or make new fonts
- The Gimp: GNU Image Manipulation Program
- Gnome: the GNU desktop environment
- Emacs: a very powerful editor
- Ghostscript and Ghostview: interpreter and graphical frontend for PostScript files.
- GNU Photo: software for interaction with digital cameras
- Octave: a programming language, primarily intended to perform numerical computations and image processing.
- GNU SQL: relational database system
- Radius: a remote authentication and accounting server
- ...

Many commercial applications are available for Linux, and for more information about these packages we refer to their specific documentation. Throughout this guide we will only discuss freely available software, which comes (in most cases) with a GNU license.

To install missing or new packages, you will need some form of software management. The most common implementations include RPM, dpkg and Ximian Red Carpet. RPM is the RedHat Package Manager, which is used on a variety of Linux systems, even though the name does not suggest this. Dpkg is the Debian package management system, which uses an interface called **apt-get**, that can manage RPM packages as well. Ximian Red Carpet is a third party implementation of RPM with a graphical front-end. Other third party software vendors may have their own installation procedures, sometimes resembling the InstallShield and such, as known on MS Windows and other platforms. As you advance into Linux, you will likely get in touch with one or more of these programs.

1.5.2. GNU/Linux

The Linux kernel (the *bones* of your system, see [Section 3.2.3.1](#)) is not part of the GNU project but uses the same license as GNU software. A great majority of utilities and development tools (the *meat* of your system), which are not Linux-specific, are taken from the GNU project. Because any usable system must contain both the kernel and at least a minimal set of utilities, some people argue that such a system should be called a *GNU/Linux* system.

In order to obtain the highest possible degree of independence between distributions, this is the sort of Linux that we will discuss throughout this course. If we are not talking about a GNU/Linux system, the specific distribution, version or program name will be mentioned.

1.5.3. Which distribution should I install?

Prior to installation, the most important factor is your hardware. Since every Linux distribution contains the basic packages and can be built to meet almost any requirement (because they all use the Linux kernel), you only need to consider if the distribution will run on your hardware. LinuxPPC for example has been made to run on MacIntosh and other PowerPCs and does not run on an ordinary x86 based PC. LinuxPPC does run on the new Macs, but you can't use it for some of the older ones with ancient bus technology. Another tricky case is Sun hardware, which could be an old SPARC CPU or a newer UltraSparc, both requiring different versions of Linux.

Some Linux distributions are optimized for certain processors, such as Athlon CPUs, while they will at the same time run decent enough on the standard 486, 586 and 686 Intel processors. Sometimes distributions for special CPUs are not as reliable, since they are tested by fewer people.

Most Linux distributions offer a set of programs for generic PCs with special packages containing optimized kernels for the x86 Intel based CPUs. These distributions are well-tested and maintained on a regular basis, focusing on reliable server implementation and easy installation and update procedures. Examples are RedHat, SuSE and Mandrake, which are by far the most popular Linux systems and generally considered easy to handle for the beginning user, while not blocking professionals from getting the most out of their Linux machines. Linux also runs decently on laptops and middle-range servers. Drivers for new hardware are included only after extensive testing, which adds to the stability of a system.

While the standard desktop might be Gnome on one system, another might offer KDE by default. Generally, both Gnome and KDE are available for all major Linux distributions. Other window and desktop managers are available for more advanced users.

Introduction to Linux

The standard installation process allows users to choose between different basic setups, such as a workstation, where all packages needed for everyday use and development are installed, or a server installation, where different network services can be selected. Expert users can install every combination of packages they want during the initial installation process.

The goal of this guide is to apply to all Linux distributions. For your own convenience, however, it is strongly advised that beginners stick to a mainstream distribution, supporting all common hardware and applications by default. The following are very good choices for novices:

- [RedHat Linux](#)
- [SuSE Linux](#)
- [Mandrake](#)
- [Knoppix](#): an operating system that runs from your CD-ROM, you don't need to install anything.

Downloadable ISO-images can be obtained from [LinuxISO.org](#). The main distributions can be purchased in any decent computer shop.

1.6. Summary

In this chapter, we learned that:

- Linux is an implementation of UNIX.
 - The Linux operating system is written in the C programming language.
 - De gustibus et coloribus non disputandum est: there's a Linux for everyone.
 - Linux uses GNU tools, a set of freely available standard tools for handling the operating system.
-

1.7. Exercises

A practical exercise for starters: install Linux on your PC. Read the installation manual for your distribution and/or the Installation HOWTO and do it.



Read the docs!

Most errors stem from not reading the information provided during the install. Reading the installation messages carefully is the first step on the road to success.

Things you must know BEFORE starting a Linux installation:

- Will this distribution run on my hardware?

Check with <http://www.ibiblio.org/mdw/HOWTO/Hardware-HOWTO/index.html> when in doubt about compatibility of your hardware.

- What kind of keyboard do I have (number of keys, layout)? What kind of mouse (serial/parallel, number of buttons)? How many MB of RAM?
- Will I install a basic workstation or a server, or will I need to select specific packages myself?
- Will I install from my hard disk, from a CD-ROM, or using the network? Should I adapt the BIOS for any of this? Does the installation method require a boot disk?
- Will Linux be the only system on this computer, or will it be a dual boot installation? Should I make a large partition in order to install virtual systems later on, or is this a virtual installation itself?

Introduction to Linux

- Is this computer in a network? What is its hostname, IP address? Are there any gateway servers or other important networked machines my box should communicate with?

Linux expects to be networked

Not using the network or configuring it incorrectly may result in slow startup.

- Is this computer a gateway/router/firewall? (If you have to think about this question, it probably isn't.)
- Partitioning: let the installation program do it for you this time, we will discuss partitions in detail in [Chapter 3](#). There is system-specific documentation available if you want to know everything about it. If your Linux distribution does not offer default partitioning, that probably means it is not suited for beginners.
- Will this machine start up in text mode or in graphical mode?
- Think of a good password for the administrator of this machine (root). Create a non-root user account (non-privileged access to the system).
- Do I need a rescue disk? (recommended)
- Which languages do I want?

The full checklist can be found at <http://www.ibiblio.org/mdw/HOWTO/Installation-HOWTO/index.html>.

In the following chapters we will find out if the installation has been successful.

Chapter 2. Quickstart

In order to get the most out of this guide, we will immediately start with a practical chapter on connecting to the Linux system and doing some basic things.

We will discuss:

- ◆ Connecting to the system
 - ◆ Disconnecting from the system
 - ◆ Text and graphic mode
 - ◆ Changing your password
 - ◆ Navigating through the file system
 - ◆ Determining file type
 - ◆ Looking at text files
 - ◆ Finding help
-

2.1. Logging in, activating the user interface and logging out

2.1.1. Introduction

In order to work on a Linux system directly, you will need to provide a user name and password. You always need to authenticate to the system. As we already mentioned in the exercise from [Chapter 1](#), most PC-based Linux systems have two basic modes for a system to run in: either quick and sober in text console mode, which looks like DOS with mouse, multitasking and multi-user features, or in graphical console mode, which looks better but eats more system resources.

2.1.2. Graphical mode

This is the default nowadays on most desktop computers. You know you will connect to the system using graphical mode when you are first asked for your user name, and then, in a new window, to type your password.

To log in, make sure the mouse pointer is in the login window, provide your user name and password to the system and click OK or press **Enter**.

Careful with that root account!

It is generally considered a bad idea to connect (graphically) using the *root* user name, the system administrator's account, since the use of graphics includes running a lot of extra programs, in root's case with a lot of extra permissions. To keep all risks as low as possible, use a normal user account to connect graphically. But there are enough risks to keep this in mind as a general advice, for all use of the root account: only log in as root when extra privileges are required.

After entering your user name/password combination, it can take a little while before the graphical environment is started, depending on the CPU speed of your computer, on the software you use and on your personal settings.

Introduction to Linux

To continue, you will need to open a *terminal window* or *xterm* for short (X being the name for the underlying software supporting the graphical environment). This program can be found in the Applications→Utilities, System Tools or Internet menu, depending on what window manager you are using. There might be icons that you can use as a shortcut to get an xterm window as well, and clicking the right mouse button on the desktop background will usually present you with a menu containing a terminal window application.

While browsing the menus, you will notice that a lot of things can be done without entering commands via the keyboard. For most users, the good old point-'n'-click method of dealing with the computer will do. But this guide is for future network and system administrators, who will need to meddle with the heart of the system. They need a stronger tool than a mouse to handle all the tasks they will face. This tool is the shell, and when in graphical mode, we activate our shell by opening a terminal window.

The terminal window is your control panel for the system. Almost everything that follows is done using this simple but powerful text tool. A terminal window should always show a command prompt when you open one. This terminal shows a standard prompt, which displays the user's login name, and the current working directory, represented by the twiddle (~):

Figure 2–1. Terminal window

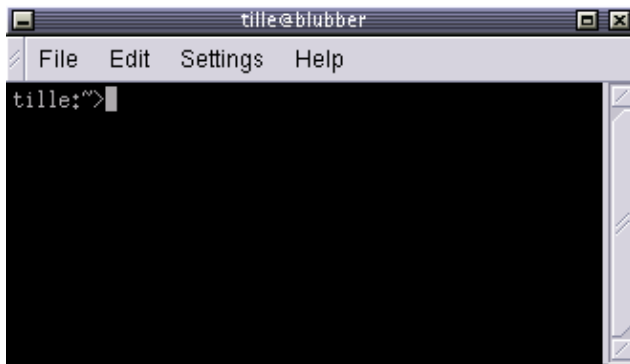

Another common form for a prompt is this one:

```
[user@host dir]
```

In the above example, *user* will be your login name, *hosts* the name of the machine you are working on, and *dir* an indication of your current location in the file system.

Later we will discuss prompts and their behavior in detail. For now, it suffices to know that prompts can display all kinds of information, but that they are not part of the commands you are giving to your system.

To disconnect from the system in graphical mode, you need to close all terminal windows and other applications. After that, hit the logout icon or find Log Out in the menu. Closing everything is not really necessary, and the system can do this for you, but session management might put all currently open applications back on your screen when you connect again, which takes longer and is not always the desired effect. However, this behavior is configurable.

When you see the login screen again, asking to enter user name and password, logout was successful.

2.1.3. Text mode

You know you're in text mode when the whole screen is black, showing (in most cases white) characters. A text mode login screen typically shows some information about the machine you are working on, the name of the machine and a prompt waiting for you to log in:

```
RedHat Linux Release 8.0 (Psyche)
blast login: _
```

The login is different from a graphical login, in that you have to hit the **Enter** key after providing your user name, because there are no buttons on the screen that you can click with the mouse. Then you should type your password, followed by another **Enter**. You won't see any indication that you are entering something, not even an asterisk, and you won't see the cursor move. But this is normal on Linux and is done for security reasons.

When the system has accepted you as a valid user, you may get some more information, called the *message of the day*, which can be anything. Additionally, it is popular on UNIX systems to display a fortune cookie, which contains some general wise or unwise (this is up to you) thoughts. After that, you will be given a shell, indicated with the same prompt that you would get in graphical mode.

Don't log in as root

Also in text mode: log in as root only to do setup and configuration that absolutely requires administrator privileges, such as adding users, installing software packages, and performing network and other system configuration. Once you are finished, immediately leave the special account and resume your work as a non-privileged user.

Logging out is done by entering the **logout** command, followed by **Enter**. You are successfully disconnected from the system when you see the login screen again.

Don't hit the power button!

Don't power-off the computer after logging out. It is not meant to be shut off without application of the proper procedures for halting the system. Powering it off without going through the halting process might cause severe damage!

Now that we know how to connect to and disconnect from the system, we're ready for our first commands.

2.2. Absolute basics

2.2.1. The commands

These are the quickies, which we need to get started; we will discuss them later in more detail.

Table 2–1. Quickstart commands

Command	Meaning
ls	Displays a list of files in the current working directory, like the dir command in DOS
cd directory	change directories
passwd	change the password for the current user
file filename	display file type of file with name <i>filename</i>
cat textfile	throws content of <i>textfile</i> on the screen
pwd	display present working directory
exit or logout	leave this session
man command	read man pages on command
info command	read Info pages on command
apropos string	search the <i>whatis</i> database for strings

2.2.2. General remarks

You type these commands after the prompt, in a terminal window in graphical mode or in text mode, followed by **Enter**.

Commands can be issued by themselves, such as **ls**. A command behaves different when you specify an *option*, usually preceded with a dash (-), as in **ls -a**. The same option character may have a different meaning for another command. GNU programs take long options, preceded by two dashes (--), like **ls --all**. Some commands have no options.

The argument(s) to a command are specifications for the object(s) on which you want the command to take effect. An example is **ls /etc**, where the directory */etc* is the argument to the **ls** command. This indicates that you want to see the content of that directory, instead of the default, which would be the content of the current directory, obtained by just typing **ls** followed by **Enter**. Some commands require arguments, sometimes arguments are optional.

You can find out whether a command takes options and arguments, and which ones are valid, by checking the online help for that command, see [Section 2.3](#).

In Linux, like in UNIX, directories are separated using forward slashes, like the ones used in web addresses (URLs). We will discuss directory structure in-depth later.

The symbols `.` and `..` have special meaning when directories are concerned. We will try to find out about those during the exercises, and more in the next chapter.

Try to avoid logging in with or using the system administrator's account, *root*. Besides doing your normal work, most tasks, including checking the system, collecting information etc., can be executed using a normal user account with no special permissions at all. If needed, for instance when creating a new user or installing new software, the preferred way of obtaining root access is by switching user IDs, see [Section 3.2.1](#) for an example.

Almost all commands in this book can be executed without system administrator privileges. In most cases, when issuing a command or starting a program as a non-privileged user, the system will warn you or prompt you for the root password when root access is required. Once you've done, leave the application or session that gives you root privileges immediately.

Reading documentation should become your second nature. Especially in the beginning, it is important to read system documentation, manuals for basic commands, HOWTOs and so on. Since the amount of documentation is so enormous, it is impossible to include all related documentation. This book will try to guide you to the most appropriate documentation on every subject discussed, in order to stimulate the habit of reading the man pages.

2.2.3. Using Bash features

Several special key combinations allow you to do things easier and faster with the GNU shell, Bash, which is the default on almost any Linux system, see [Section 3.2.3.2](#). Below is a list of the most commonly used features; you are strongly suggested to make a habit out of using them, so as to get the most out of your Linux experience from the very beginning.

Table 2–2. Key combinations in Bash

Key or key combination	Function
Ctrl+A	Move cursor to the beginning of the command line.
Ctrl+C	End a running program and return the prompt, see Chapter 4 .
Ctrl+D	Log out of the current shell session, equal to typing exit or logout .
Ctrl+E	Move cursor to the end of the command line.
Ctrl+H	Generate backspace character.
Ctrl+L	Clear this terminal.
Ctrl+R	Search command history, see Section 3.3.3.4 .
Ctrl+Z	Suspend a program, see Chapter 4 .
ArrowLeft and ArrowRight	Move the cursor one place to the left or right on the command line, so that you can insert characters at other places than just at the beginning and the end.
ArrowUp and ArrowDown	Browse history. Go to the line that you want to repeat, eventually edit details, and press Enter to save time.
Shift+PageUp and Shift+PageDown	Browse terminal buffer (to see text that has "scrolled off" the screen).
Tab	Command or filename completion; when multiple choices are possible, the system will either signal with an audio or visual bell, or, if too many choices are possible, ask you if you want to see them all.
Tab Tab	Shows file or command completion possibilities.

The last two items in the above table may need some extra explanations. For instance, if you want to change into the directory `directory_with_a_very_long_name`, you are not going to type that very long name, no. You just type on the command line `cd dir`, then you press **Tab** and the shell completes the name for you, if no other files are starting with the same three characters. Of course, if there are no other items starting with "d", then you might just as well type `cd d` and then **Tab**. If more than one file starts with the same characters, the shell will signal this to you, upon which you can hit **Tab** twice with short interval, and the shell presents the choices you have:

```
your_prompt> cd st
starthere      stuff          stuffit
```

In the above example, if you type "a" after the first two characters and hit **Tab** again, no other possibilities are left, and the shell completes the directory name, without you having to type the string "rthere":

```
your_prompt> cd starthere
```

Of course, you'll still have to hit **Enter** to accept this choice.

In the same example, if you type "u", and then hit **Tab**, the shell will add the "ff" for you, but then it protests again, because multiple choices are possible. If you type **Tab Tab** again, you'll see the choices; if you type one or more characters that make the choice unambiguous to the system, and **Tab** again, or **Enter** when you've reach the end of the file name that you want to choose, the shell completes the file name and changes you into that directory – if indeed it is a directory name.

This works for all file names that are arguments to commands.

The same goes for command name completion. Typing **ls** and then hitting the **Tab** key twice, lists all the commands in your PATH (see [Section 3.2.1](#)) that start with these two characters:

```
your_prompt> ls
ls          lsdev      lspci      lsraid     lsw
lsattr      lsmod      lspgpot    lss16toppm
lsb_release lsof       lspnp      lsusb
```

2.3. Getting help

2.3.1. Be warned

GNU/Linux is all about becoming more self-reliant. And as usual with this system, there are several ways to achieve the goal. A common way of getting help is finding someone who knows, and however patient and peace-loving the Linux-using community will be, almost everybody will expect you to have tried one or more of the methods in this section before asking them, and the ways in which this viewpoint is expressed may be rather harsh if you prove not to have followed this basic rule.

2.3.2. The man pages

A lot of beginning users fear the man (manual) pages, because they are an overwhelming source of documentation. They are, however, very structured, as you will see from the example below on: **man man**.

Reading man pages is usually done in a terminal window when in graphical mode, or just in text mode if you prefer it. Type the command like this at the prompt, followed by **Enter**:

```
yourname@yourcomp ~> man man
```

The documentation for **man** will be displayed on your screen after you press **Enter**:

```
man(1)                                                    man(1)

NAME
man - format and display the on-line manual pages
```

Introduction to Linux

```
manpath - determine user's search path for man pages
```

SYNOPSIS

```
man [-acdfFhkKtwW] [--path] [-m system] [-p string] [-C config_file]
[-M pathlist] [-P pager] [-S section_list] [section] name ...
```

DESCRIPTION

man formats and displays the on-line manual pages. If you specify section, man only looks in that section of the manual. name is normally the name of the manual page, which is typically the name of a command, function, or file. However, if name contains a slash (/) then man interprets it as a file specification, so that you can do man ./foo.5 or even man /cd/foo/bar.1.gz.

See below for a description of where man looks for the manual page files.

OPTIONS

```
-C config_file
lines 1-27
```

Browse to the next page using the space bar. You can go back to the previous page using the **b**-key. When you reach the end, **man** will quit and you get the prompt back, or type **q** if you want to leave the man page before reaching the end.

Each man page usually contains a couple of standard sections, as we can see from the **man man** example:

- The first line contains the name of the command you are reading about, and the id of the section in which this man page is located. The man pages are ordered in chapters. Commands are likely to have multiple man pages, for example the man page from the user section, the man page from the system admin section, and the man page from the programmer section.
- The name of the command and a short description are given, which is used for building an index of the man pages. You can look for any given search string in this index using the **apropos** command.
- The synopsis of the command provides a technical notation of all the options and/or arguments this command can take. You can think of an option as a way of executing the command. The argument is what you execute it on. Some commands have no options or no arguments. Optional options and arguments are put in between "[" and "]" to indicate that they can be left out.
- A longer description of the command is given.
- Options with their descriptions are listed. Options can usually be combined. If not so, this section will tell you about it.
- Environment describes the shell variables that influence the behavior of this command (not all commands have this).
- Sometimes sections specific to this command are provided, such as the CAT PAGES section in the example.
- A reference to other man pages is given in the "SEE ALSO" section. In between parentheses is the number of the man page section in which to find this command. Experienced users often switch to the "SEE ALSO" part using the / command followed by the search string SEE and press **Enter**.
- Usually there is also information about known bugs (anomalies) and where to report new bugs you may find.
- There might also be author and copyright information.

Some commands have multiple man pages. For instance, the **passwd** command has a man page in section 1 and another in section 5. By default, the man page with the lowest number is shown. If you want to see

another section than the default, specify it after the **man** command:

```
man 5 passwd
```

If you want to see all man pages about a command, one after the other, use the **-a** to man:

```
man -a passwd
```

This way, when you reach the end of the first man page and press **SPACE** again, the man page from the next section will be displayed.

2.3.3. More info

2.3.3.1. The Info pages

In addition to the man pages, you can read the info pages about a command, using the **info** command. These usually contain more recent information and are somewhat easier to use. The man pages for some commands refer to the info pages.

Get started by typing **info info** in a terminal window:

```
File: info.info, Node: Top, Next: Getting Started, Up: (dir)

Info: An Introduction
*****

Info is a program, which you are using now, for reading
documentation of computer programs. The GNU Project distributes most
of its on-line manuals in the Info format, so you need a program called
"Info reader" to read the manuals. One of such programs you are using
now.

If you are new to Info and want to learn how to use it, type the
command `h' now. It brings you to a programmed instruction sequence.

To learn advanced Info commands, type `n' twice. This brings you to
`Info for Experts', skipping over the `Getting Started' chapter.

* Menu:

* Getting Started::          Getting started using an Info reader.
* Advanced Info::          Advanced commands within Info.
* Creating an Info File::    How to make your own Info file.
--zz-Info: (info.info.gz)Top, 24 lines --Top-----
Welcome to Info version 4.2. Type C-h for help, m for menu item.
```

Use the arrow keys to browse through the text and move the cursor on a line starting with an asterisk, containing the keyword about which you want info, then hit **Enter**. Use the **P** and **N** keys to go to the previous or next subject. The space bar will move you one page further, no matter whether this starts a new subject or an info page for another command. Use **Q** to quit. The **info** program has more information.

2.3.3.2. The **whatis** and **apropos** commands

A short index of explanations for commands is available using the **whatis** command, like in the examples below:

```
[your_prompt] whatis ls
ls                (1) - list directory contents
```

This displays short information about a command, and the first section in the collection of man pages that contains an appropriate page.

If you don't know where to get started and which man page to read, **apropos** gives more information. Say that you don't know how to start a browser, then you could enter the following command:

```
another_prompt> apropos browser
Galeon [galeon](1) - gecko-based GNOME web browser
lynx                (1) - a general purpose distributed information browser
                    for the World Wide Web
ncftp               (1) - Browser program for the File Transfer Protocol
opera               (1) - a graphical web browser
pilot               (1) - simple file system browser in the style of the
                    Pine Composer
pinfo               (1) - curses based lynx-style info browser
pinfo [pman]       (1) - curses based lynx-style info browser
viewres             (1x) - graphical class browser for Xt
```

After pressing **Enter** you will see that a lot of browser related stuff is on your machine: not only web browsers, but also file and FTP browsers, and browsers for documentation. If you have development packages installed, you may also have the accompanying man pages dealing with writing programs having to do with browsers. Generally, a command with a man page in section one, so one marked with "(1)", is suitable for trying out as a user. The user who issued the above **apropos** might consequently try to start the commands **galeon**, **lynx** or **opera**, since these clearly have to do with browsing the world wide web.

2.3.3.3. The **--help** option

Most GNU commands support the **--help**, which gives a short explanation about how to use the command and a list of available options. Below is the output of this option with the **cat**:

```
userprompt@host: cat --help
Usage: cat [OPTION] [FILE]...
Concatenate FILE(s), or standard input, to standard output.

-A, --show-all          equivalent to -vET
-b, --number-nonblank    number nonblank output lines
-e                      equivalent to -vE
-E, --show-ends         display $ at end of each line
-n, --number            number all output lines
-s, --squeeze-blank     never more than one single blank line
-t                      equivalent to -vT
-T, --show-tabs         display TAB characters as ^I
-u                      (ignored)
-v, --show-nonprinting  use ^ and M- notation,
                        except for LFD and TAB

--help    display this help and exit
--version output version information and exit
```

With no FILE, or when FILE is -, read standard input.

Report bugs to <bug-textutils@gnu.org>.

2.3.3.4. Graphical help

Don't despair if you prefer a graphical user interface. Konqueror, the default KDE file manager, provides painless and colourful access to the man and Info pages. You may want to try "info:info" in the *Location* address bar, and you will get a browsable Info page about the **info** command. Similarly, "man:ls" will present you with the man page for the **ls** command. You even get command name completion: you will see the man pages for all the commands starting with "ls" in a scroll-down menu. Entering "info:/dir" in the address location toolbar displays all the Info pages, arranged in utility categories. Excellent Help content, including the Konqueror Handbook. Start up from the menu or by typing the command **konqueror** in a terminal window, followed by **Enter**; see the screenshot below.

Figure 2–2. Konqueror as help browser

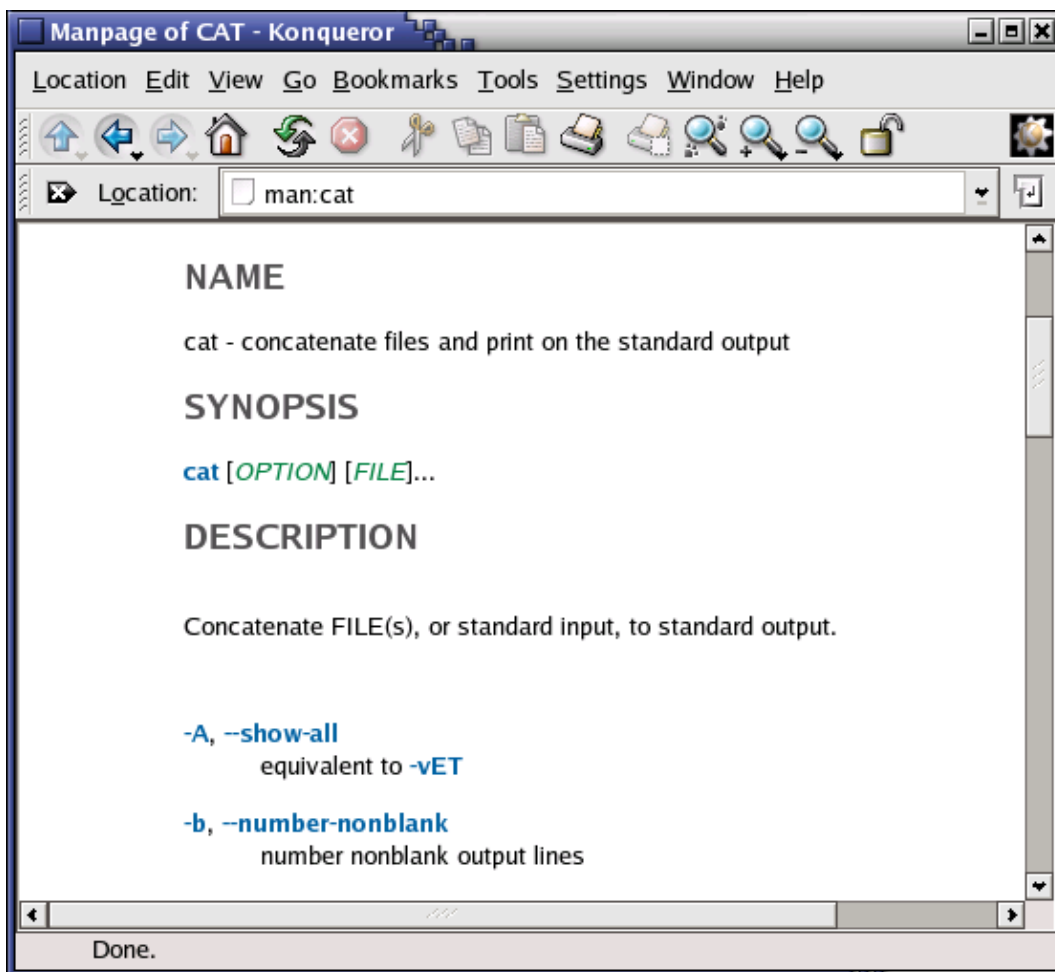

The Gnome Help Browser is very user friendly as well. You can start it selecting Applications→Help from the Gnome menu, by clicking the lifeguard icon on your desktop or by entering the command **gnome-help** in a terminal window. The system documentation and man pages are easily browsable with a plain interface.

The **nautilus** file manager provides a searchable index of the man and Info pages, they are easily browsable and interlinked. Nautilus is started from the command line, or clicking your home directory icon, or from the Gnome menu.

The big advantage of GUIs for system documentation is that all information is completely interlinked, so you can click through in the "SEE ALSO" sections and wherever links to other man pages appear, and thus browse and acquire knowledge without interruption for hours at the time.

2.3.3.5. Exceptions

Some commands don't have separate documentation, because they are part of another command. **cd**, **exit**, **logout** and **pwd** are such exceptions. They are part of your shell program and are called *shell built-in* commands. For information about these, refer to the man or info page of your shell. Most beginning Linux users have a Bash shell. See [Section 3.2.3.2](#) for more about shells.

If you have been changing your original system configuration, it might also be possible that man pages are still there, but not visible because your shell environment has changed. In that case, you will need to check the `MANPATH` variable. How to do this is explained in [Section 7.2.1.2](#).

Some programs or packages only have a set of instructions or references in the directory `/usr/share/doc`. See [Section 3.3.4](#) to display.

In the worst case, you may have removed the documentation from your system by accident (hopefully by accident, because it is a very bad idea to do this on purpose). In that case, first try to make sure that there is really nothing appropriate left using a search tool, read on in [Section 3.3.3](#). If so, you may have to re-install the package that contains the command to which the documentation applied, see [Section 7.6](#).

2.4. Summary

Linux traditionally operates in text mode or in graphical mode. Since CPU power and RAM are not the cost anymore these days, every Linux user can afford to work in graphical mode and will usually do so. This does not mean that you don't have to know about text mode: we will work in the text environment throughout this course, using a terminal window.

Linux encourages its users to acquire knowledge and to become independent. Inevitably, you will have to read a lot of documentation to achieve that goal; that is why, as you will notice, we refer to extra documentation for almost every command, tool and problem listed in this book. The more docs you read, the easier it will become and the faster you will leaf through manuals. Make reading documentation a habit as soon as possible. When you don't know the answer to a problem, referring to the documentation should become a second nature.

2.5. Exercises

Most of what we learn is by making mistakes and by seeing how things can go wrong. These exercises are made to get you to read some error messages. The order in which you do these exercises is important.

Don't forget to use the Bash features on the command line: try to do the exercises typing as few characters as possible!

2.5.1. Connecting and disconnecting

- Determine whether you are working in text or in graphical mode.

I am working in text/graphical mode. (cross out what's not applicable)

- Log in with the user name and password you made for yourself during the installation.
- Log out.
- Log in again, using a non-existent user name

→ What happens?

2.5.2. Passwords

Log in again with your user name and password.

- Change your password into *P6p3.aa!* and hit the **Enter** key.

→ What happens?

- Try again, this time enter a password that is ridiculously easy, like *123* or *aaa*.

→ What happens?

- Try again, this time don't enter a password but just hit the **Enter** key.

→ What happens?

- Try the command **psswd** instead of **passwd**

→ What happens?

2.5.3. Directories

These are some exercises to help you get the feel.

- Enter the command **cd blah**

→ What happens?

- Enter the command **cd ..**

Mind the space between "cd" and ".."! Use the **pwd** command.

→ What happens?

- List the directory contents with the **ls** command.

→ What do you see?

→ What do you think these are?

→ Check using the **pwd** command.

- Enter the **cd** command.

→ What happens?

- Repeat step 2 two times.
 - What happens?
- Display the content of this directory.
- Try the command **cd root**
 - What happens?
 - To which directories do you have access?
- Repeat step 4.

Do you know another possibility to get where you are now?

2.5.4. Files

- Change directory to / and then to `etc`. Type **ls**; if the output is longer than your screen, make the window longer, or try **Shift+PageUp** and **Shift+PageDown**.

The file `inittab` contains the answer to the first question in this list. Try the **file** command on it.

- The file type of my `inittab` is
 - Use the command **cat inittab** and read the file.
 - What is the default mode of your computer?
 - Return to your home directory using the **cd** command.
 - Enter the command **file .**
 - Does this help to find the meaning of "."?
 - Can you look at "." using the **cat** command?
 - Display help for the **cat** program, using the `--help` option. Use the option for numbering of output lines to count how many users are listed in the file `/etc/passwd`.
-

2.5.5. Getting help

- Read **man intro**
 - Read **man ls**
 - Read **info passwd**
 - Enter the **apropos pwd** command.
 - Try **man** or **info** on **cd**.
 - How would you find out more about **cd**?
 - Read **ls --help** and try it out.
-

Chapter 3. About files and the file system

After the initial exploration in [Chapter 2](#), we are ready to discuss the files and directories on a Linux system in more detail. Many users have difficulties with Linux because they lack an overview of what kind of data is kept in which locations. We will try to shine some light on the organization of files in the file system.

We will also list the most important files and directories and use different methods of viewing the content of those files, and learn how files and directories can be created, moved and deleted.

After completion of the exercises in this chapter, you will be able to:

- ◆ Describe the layout of a Linux file system
- ◆ Display and set paths
- ◆ Describe the most important files, including kernel and shell
- ◆ Find lost and hidden files
- ◆ Create, move and delete files and directories
- ◆ Display contents of files
- ◆ Understand and use different link types
- ◆ Find out about file properties and change file permissions

3.1. General overview of the Linux file system

3.1.1. Files

3.1.1.1. General

A simple description of the UNIX system, also applicable to Linux, is this:

"On a UNIX system, everything is a file; if something is not a file, it is a process."

This statement is true because there are special files that are more than just files (named pipes and sockets, for instance), but to keep things simple, saying that everything is a file is an acceptable generalization. A Linux system, just like UNIX, makes no difference between a file and a directory, since a directory is just a file containing names of other files. Programs, services, texts, images, and so forth, are all files. Input and output devices, and generally all devices, are considered to be files, according to the system.

In order to manage all those files in an orderly fashion, man likes to think of them in an ordered tree-like structure on the hard disk, as we know from MS-DOS (Disk Operating System) for instance. The large branches contain more branches, and the branches at the end contain the tree's leaves or normal files. For now we will use this image of the tree, but we will find out later why this is not a fully accurate image.

3.1.1.2. Sorts of files

Most files are just files, called *regular* files; they contain normal data, for example text files, executable files or programs, input for or output from a program and so on.

While it is reasonably safe to suppose that everything you encounter on a Linux system is a file, there are some exceptions.

- *Directories*: files that are lists of other files.
- *Special files*: the mechanism used for input and output. Most special files are in `/dev`, we will discuss them later.
- *Links*: a system to make a file or directory visible in multiple parts of the system's file tree. We will talk about links in detail.
- *(Domain) sockets*: a special file type, similar to TCP/IP sockets, providing inter-process networking protected by the file system's access control.
- *Named pipes*: act more or less like sockets and form a way for processes to communicate with each other, without using network socket semantics.

The `-l` option to `ls` displays the file type, using the first character of each input line:

```
jaime:~/Documents> ls -l
total 80
-rw-rw-r--  1 jaime  jaime  31744 Feb 21 17:56 intro Linux.doc
-rw-rw-r--  1 jaime  jaime  41472 Feb 21 17:56 Linux.doc
drwxrwxr-x  2 jaime  jaime   4096 Feb 25 11:50 course
```

This table gives an overview of the characters determining the file type:

Table 3–1. File types in a long list

Symbol	Meaning
-	Regular file
d	Directory
l	Link
c	Special file
s	Socket
p	Named pipe

In order not to always have to perform a long listing for seeing the file type, a lot of systems by default don't issue just `ls`, but `ls -F`, which suffixes file names with one of the characters `"/=*|@"` to indicate the file type. To make it extra easy on the beginning user, both the `-F` and `--color` options are usually combined, see [Section 3.3.1.1](#). We will use `ls -F` throughout this document for better readability.

As a user, you only need to deal directly with plain files, executable files, directories and links. The special file types are there for making your system do what you demand from it and are dealt with by system administrators and programmers.

Now, before we look at the important files and directories, we need to know more about partitions.

3.1.2. About partitioning

3.1.2.1. Why partition?

Most people have a vague knowledge of what partitions are, since every operating system has the ability to create or remove them. It may seem strange that Linux uses more than one partition on the same disk, even when using the standard installation procedure, so some explanation is called for.

The goal of having different partitions is primarily to achieve higher data security in case of disaster. By dividing the hard disk in partitions, data can be grouped and separated. When an accident occurs, only the data in the partition that got the hit will be damaged, while the data on the other partitions will most likely survive.

This principle dates from the days when Linux didn't have journaled file systems and power failures might have led to disaster. The use of partitions remains for security and robustness reasons, so a breach on one part of the system doesn't automatically mean that the whole computer is in danger. This is currently the most important reason for partitioning.

Mind that having a journaled file system only provides data security in case of power failure and sudden disconnection of storage devices. This does not protect your data against bad blocks and logical errors in the file system. In those cases, you should use a RAID (Redundant Array of Inexpensive Disks) solution.

3.1.2.2. Partition layout and types

There are two kinds of major partitions on a Linux system:

- *data partition*: normal Linux system data, including the *root partition* containing all the data to start up and run the system; and
- *swap partition*: expansion of the computer's physical memory, extra memory on hard disk.

Most systems contain a root partition, one or more data partitions and one or more swap partitions. Systems in mixed environments may contain partitions for other system data, such as a partition with a FAT or VFAT file system for MS Windows data.

Most Linux systems use **fdisk** at installation time to set the partition type. As you may have noticed during the exercise from Chapter 1, this usually happens automatically. On some occasions, however, you may not be so lucky. In such cases, you will need to select the partition type manually and even manually do the actual partitioning. The standard Linux partitions have number 82 for swap and 83 for data, which can be journaled (ext3) or normal (ext2, on older systems). The **fdisk** utility has built-in help, should you forget these values.

Apart from these two, Linux supports a variety of other file system types, such as the relatively new Reiser file system, JFS, NFS, FATxx and many other file systems natively available on other (proprietary) operating systems.

The standard root partition (indicated with a single forward slash, /) is about 100–500 MB, and contains the system configuration files, most basic commands and server programs, system libraries, some temporary space and the home directory of the administrative user. A standard installation requires about 250 MB for the root partition.

Swap space (indicated with *swap*) is only accessible for the system itself, and is hidden from view during normal operation. Swap is the system that ensures, like on normal UNIX systems, that you can keep on working, whatever happens. On Linux, you will virtually never see irritating messages like *Out of memory, please close some applications first and try again*, because of this extra memory. The swap or virtual memory procedure has long been adopted by operating systems outside the UNIX world by now.

Introduction to Linux

Using memory on a hard disk is naturally slower than using the real memory chips of a computer, but having this little extra is a great comfort. We will learn more about swap when we discuss Processes in [Chapter 4](#).

Linux generally counts on having twice the amount of physical memory in the form of swap space on the hard disk. When installing a system, you have to know how you are going to do this. An example on a system with 512 MB of RAM:

- 1st possibility: one swap partition of 1 GB
- 2nd possibility: two swap partitions of 512 MB
- 3rd possibility: with two hard disks: 1 partition of 512 MB on each disk.

The last option will give the best results when a lot of I/O is to be expected.

Read the software documentation for specific guidelines. Some applications, such as databases, might require more swap space. Others, such as some handheld systems, might not have any swap at all by lack of a hard disk. Swap space may also depend on your kernel version.

The kernel is on a separate partition as well in many distributions, because it is the most important file of your system. If this is the case, you will find that you also have a */boot* partition, holding your kernel(s) and accompanying data files.

The rest of the hard disk(s) is generally divided in data partitions, although it may be that all of the non-system critical data resides on one partition, for example when you perform a standard workstation installation. When non-critical data is separated on different partitions, it usually happens following a set pattern:

- a partition for user programs (*/usr*)
- a partition containing the users' personal data (*/home*)
- a partition to store temporary data like print- and mail-queues (*/var*)
- a partition for third party and extra software (*/opt*)

Once the partitions are made, you can only add more. Changing sizes or properties of existing partitions is possible but not advisable.

The division of hard disks into partitions is determined by the system administrator. On larger systems, he or she may even spread one partition over several hard disks, using the appropriate software. Most distributions allow for standard setups optimized for workstations (average users) and for general server purposes, but also accept customized partitions. During the installation process you can define your own partition layout using either your distribution specific tool, which is usually a straight forward graphical interface, or **fdisk**, a text-based tool for creating partitions and setting their properties.

A workstation or client installation is for use by mainly one and the same person. The selected software for installation reflects this and the stress is on common user packages, such as nice desktop themes, development tools, client programs for E-mail, multimedia software, web and other services. Everything is put together on one large partition, swap space twice the amount of RAM is added and your generic workstation is complete, providing the largest amount of disk space possible for personal use, but with the disadvantage of possible data integrity loss during problem situations.

On a server, system data tends to be separate from user data. Programs that offer services are kept in a different place than the data handled by this service. Different partitions will be created on such systems:

- a partition with all data necessary to boot the machine
- a partition with configuration data and server programs
- one or more partitions containing the server data such as database tables, user mails, an ftp archive etc.
- a partition with user programs and applications
- one or more partitions for the user specific files (home directories)
- one or more swap partitions (virtual memory)

Servers usually have more memory and thus more swap space. Certain server processes, such as databases, may require more swap space than usual; see the specific documentation for detailed information. For better performance, swap is often divided into different swap partitions.

3.1.2.3. The **df** command

On a running system, information about the partitions can be displayed using the **df** command (which stands for *disk full* or *disk free*). In Linux, **df** is the GNU version, and supports the `-h` or *human readable* option which greatly improves readability. Note that commercial UNIX machines commonly have their own versions of **df** and many other commands. Their behavior is usually the same, though GNU versions of common tools often have more and better features.

The **df** command only displays information about active non-swap partitions. These can include partitions from other networked systems, like in the example below where the home directories are mounted from a file server on the network, a situation often encountered in corporate environments.

```
freddy:~> df -h
Filesystem      Size  Used Avail Use% Mounted on
/dev/hda8       496M  183M  288M  39% /
/dev/hda1       124M   8.4M  109M   8% /boot
/dev/hda5       19G   15G   2.7G  85% /opt
/dev/hda6       7.0G   5.4G  1.2G  81% /usr
/dev/hda7       3.7G   2.7G  867M  77% /var
fs1:/home      8.9G   3.7G  4.7G  44% /.automount/fs1/root/home
```

Partitions are *mounted* on a mount point, which can be almost any directory in the system. In the next section, we'll take a closer look at all those directories.

3.1.3. More file system layout

3.1.3.1. Visual

For convenience, the Linux file system is usually thought of in a tree structure. On a standard Linux system you will find the layout generally follows the scheme presented below.

Figure 3–1. Linux file system layout

Introduction to Linux

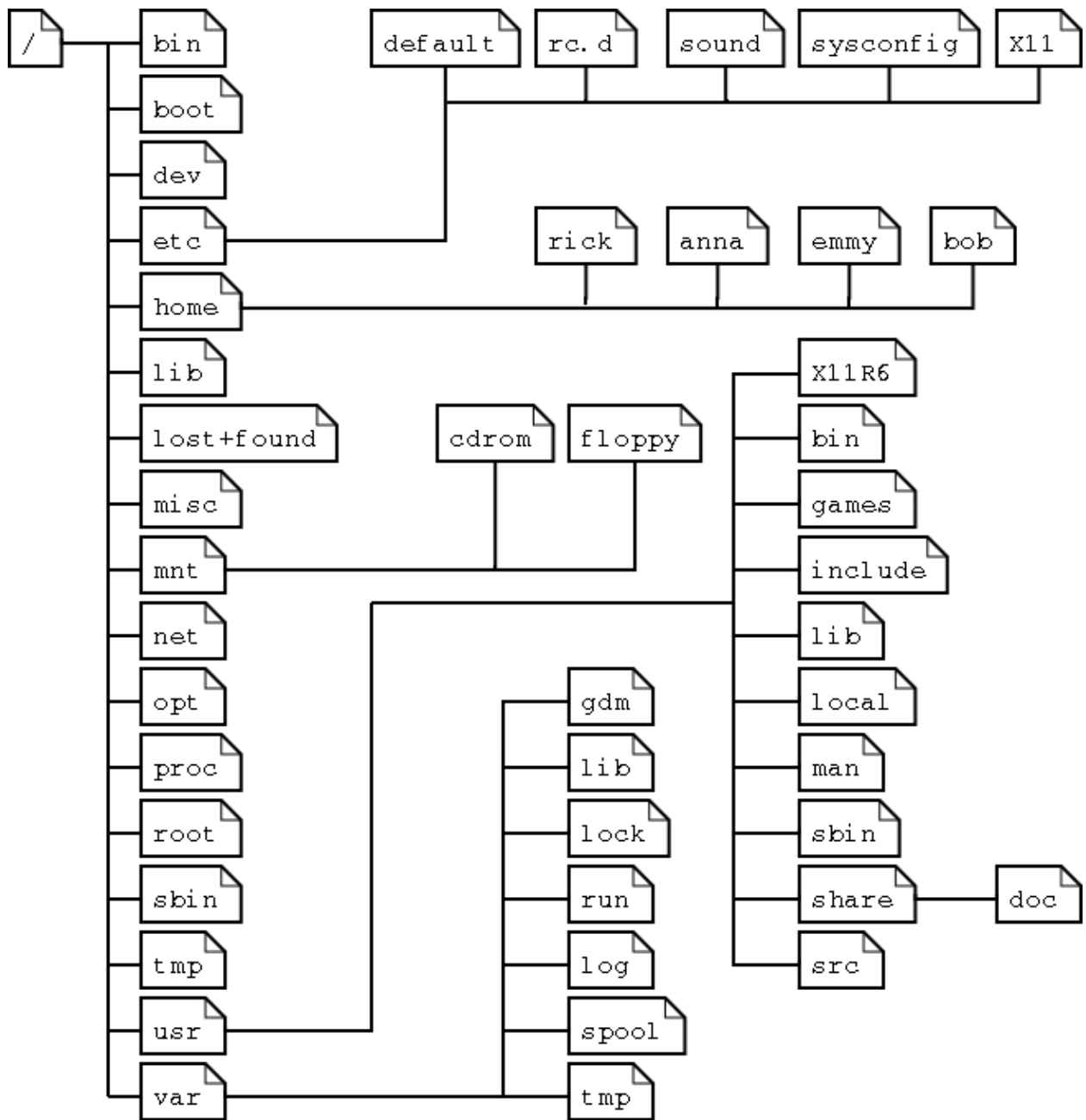

This is a layout from a RedHat system. Depending on the system admin, the operating system and the mission of the UNIX machine, the structure may vary, and directories may be left out or added at will. The names are not even required; they are only a convention.

The tree of the file system starts at the trunk or *slash*, indicated by a forward slash (/). This directory, containing all underlying directories and files, is also called the *root directory* or "the root" of the file system.

Directories that are only one level below the root directory are often preceded by a slash, to indicate their position and prevent confusion with other directories that could have the same name. When starting with a new system, it is always a good idea to take a look in the root directory. Let's see what you could run into:

```
emmy:~> cd /
```

```
emmy: /> ls
bin/   dev/   home/  lib/           misc/  opt/       root/  tmp/   var/
boot/  etc/   initrd/ lost+found/  mnt/   proc/      sbin/  usr/
```

Table 3–2. Subdirectories of the root directory

Directory	Content
/bin	Common programs, shared by the system, the system administrator and the users.
/boot	The startup files and the kernel, <code>vmlinuz</code> . In some recent distributions also <code>grub</code> data. Grub is the GRand Unified Boot loader and is an attempt to get rid of the many different boot-loaders we know today.
/dev	Contains references to all the CPU peripheral hardware, which are represented as files with special properties.
/etc	Most important system configuration files are in <code>/etc</code> , this directory contains data similar to those in the Control Panel in Windows
/home	Home directories of the common users.
/initrd	(on some distributions) Information for booting. Do not remove!
/lib	Library files, includes files for all kinds of programs needed by the system and the users.
/lost+found	Every partition has a <code>lost+found</code> in its upper directory. Files that were saved during failures are here.
/misc	For miscellaneous purposes.
/mnt	Standard mount point for external file systems, e.g. a CD-ROM or a digital camera.
/net	Standard mount point for entire remote file systems
/opt	Typically contains extra and third party software.
/proc	A virtual file system containing information about system resources. More information about the meaning of the files in <code>proc</code> is obtained by entering the command <code>man proc</code> in a terminal window. The file <code>proc.txt</code> discusses the virtual file system in detail. If you don't have a Linux machine at hand on which to locate this file, it is included in Appendix E for your convenience.
/root	The administrative user's home directory. Mind the difference between <code>/</code> , the root directory and <code>/root</code> , the home directory of the <code>root</code> user.
/sbin	Programs for use by the system and the system administrator.
/tmp	Temporary space for use by the system, cleaned upon reboot, so don't use this for saving any work!
/usr	Programs, libraries, documentation etc. for all user-related programs.
/var	Storage for all variable files and temporary files created by users, such as log files, the mail queue, the print spooler area, space for temporary storage of files downloaded from the Internet, or to keep an image of a CD before burning it.

How can you find out which partition a directory is on? Using the `df` command with a dot (`.`) as an option shows the partition the current directory belongs to, and informs about the amount of space used on this partition:

```
sandra:/lib> df -h .
Filesystem      Size  Used Avail Use% Mounted on
/dev/hda7       980M  163M  767M  18% /
```

As a general rule, every directory under the root directory is on the root partition, unless it has a separate entry in the full listing from **df** (or **df -h** with no other options).

3.1.3.2. The file system in reality

For most users and for most common system administration tasks, it is enough to accept that files and directories are ordered in a tree-like structure. The computer, however, doesn't understand a thing about trees or tree-structures.

Every partition has its own file system. By imagining all those file systems together, we can form an idea of the tree-structure of the entire system, but it is not as simple as that. In a file system, a file is represented by an *inode*, a kind of serial number containing information about the actual data that makes up the file: to whom this file belongs, and where is it located on the hard disk.

Every partition has its own set of inodes; throughout a system with multiple partitions, files with the same inode number can exist.

Each inode describes a data structure on the hard disk, storing the properties of a file, including the physical location of the file data. When a hard disk is initialized to accept data storage, usually during the initial system installation process or when adding extra disks to an existing system, a fixed number of inodes per partition is created. This number will be the maximum amount of files, of all types (including directories, special files, links etc.) that can exist at the same time on the partition. We typically count on having 1 inode per 2 to 8 kilobytes of storage.

At the time a new file is created, it gets a free inode. In that inode is the following information:

- Owner and group owner of the file.
- File type (regular, directory, ...)
- Permissions on the file [Section 3.4.1](#)
- Date and time of creation, last read and change.
- Date and time this information has been changed in the inode.
- Number of links to this file (see later in this chapter).
- File size
- An address defining the actual location of the file data.

The only information not included in an inode, is the file name and directory. These are stored in the special directory files. By comparing file names and inode numbers, the system can make up a tree-structure that the user understands. Users can display inode numbers using the **-i** option to **ls**. The inodes have their own separate space on the disk.

3.2. Orientation in the file system

3.2.1. The path

When you want the system to execute a command, you almost never have to give the full path to that command. For example, we know that the **ls** command is in the **/bin** directory (check with **which -a ls**), yet we don't have to enter the command **/bin/ls** for the computer to list the content of the current directory.

The **PATH** environment variable takes care of this. This variable lists those directories in the system where executable files can be found, and thus saves the user a lot of typing and memorizing locations of commands.

Introduction to Linux

So the path naturally contains a lot of directories containing `bin` somewhere in their names, as the user below demonstrates. The `echo` command is used to display the content ("") of the variable `PATH`:

```
rogier:> echo $PATH
/opt/local/bin:/usr/X11R6/bin:/usr/bin:/usr/sbin:/bin
```

In this example, the directories `/opt/local/bin`, `/usr/X11R6/bin`, `/usr/bin`, `/usr/sbin` and `/bin` are subsequently searched for the required program. As soon as a match is found, the search is stopped, even if not every directory in the path has been searched. This can lead to strange situations. In the first example below, the user knows there is a program called `sendsms` to send an SMS message, and another user on the same system can use it, but she can't. The difference is in the configuration of the `PATH` variable:

```
[jenny@blob jenny]$ sendsms
bash: sendsms: command not found
[jenny@blob jenny]$ echo $PATH
/bin:/usr/bin:/usr/bin/X11:/usr/X11R6/bin:/home/jenny/bin
[jenny@blob jenny]$ su - tony
Password:
tony:~>which sendsms
sendsms is /usr/local/bin/sendsms

tony:~>echo $PATH
/home/tony/bin.Linux:/home/tony/bin:/usr/local/bin:/usr/local/sbin:\
/usr/X11R6/bin:/usr/bin:/usr/sbin:/bin:/sbin
```

Note the use of the `su` (switch user) facility, which allows you to run a shell in the environment of another user, on the condition that you know the user's password.

A backslash indicates the continuation of a line on the next, without an **Enter** separating one line from the other.

In the next example, a user wants to call on the `wc` (word count) command to check the number of lines in a file, but nothing happens and he has to break off his action using the **Ctrl+C** combination:

```
jumper:~> wc -l test

(ctrl-C)
jumper:~> which wc
wc is hashed (/home/jumper/bin/wc)

jumper:~> echo $PATH
/home/jumper/bin:/usr/local/bin:/usr/local/sbin:/usr/X11R6/bin:
/usr/bin:/usr/sbin:/bin:/sbin
```

The use of the `which` command shows us that this user has a `bin`-directory in his home directory, containing a program that is also called `wc`. Since the program in his home directory is found first when searching the paths upon a call for `wc`, this "home-made" program is executed, with input it probably doesn't understand, so we have to stop it. To resolve this problem there are several ways (there are always several ways to solve a problem in UNIX/Linux): one answer could be to rename the user's `wc` program, or the user can give the full path to the exact command he wants, which can be found by using the `-a` to the `which` command:

```
jumper:~> /usr/bin/wc -l test
10 test
```

If the user uses programs in the other directories more frequently, he can change his path to look in his own directories last:

```
jumper: ~> export PATH=/usr/local/bin:/usr/local/sbin:/usr/X11R6/bin:\
/usr/bin:/usr/sbin:/bin:/sbin:/home/jumper/bin
```



Changes are not permanent!

Note that when using the **export** command in a shell, the changes are temporary and only valid for this session (until you log out). Opening new sessions, even while the current one is still running, will not result in a new path in the new session. We will see in [Section 7.2](#) how we can make these kinds of changes to the environment permanent, adding these lines to the shell configuration files.

3.2.2. Absolute and relative paths

A path, which is the way you need to follow in the tree structure to reach a given file, can be described as starting from the trunk of the tree (the / or root directory). In that case, the path starts with a slash and is called an absolute path, since there can be no mistake: only one file on the system can comply.

In the other case, the path doesn't start with a slash and confusion is possible between `~/bin/wc` (in the user's home directory) and `bin/wc` in `/usr`, from the previous example. Paths that don't start with a slash are always relative.

In relative paths we also use the `.` and `..` indications for the current and the parent directory. A couple of practical examples:

- When you want to compile source code, the installation documentation often instructs you to run the command `./configure`, which runs the `configure` program located in the current directory (that came with the new code), as opposed to running another configure program elsewhere on the system.
- In HTML files, relative paths are often used to make a set of pages easily movable to another place:

```

```

- Notice the difference one more time:

```
theo:~> ls /mp3
ls: /mp3: No such file or directory
theo:~>ls mp3/
oriental/  pop/     sixties/
```

3.2.3. The most important files and directories

3.2.3.1. The kernel

The kernel is the heart of the system. It manages the communication between the underlying hardware and the peripherals. The kernel also makes sure that processes and daemons (server processes) are started and stopped at the exact right times. The kernel has a lot of other important tasks, so many that there is a special kernel–development mailing list on this subject only, where huge amounts of information are shared. It would lead us too far to discuss the kernel in detail. For now it suffices to know that the kernel is the most important file on the system.

3.2.3.2. The shell

3.2.3.2.1. What is a shell?

When I was looking for an appropriate explanation on the concept of a *shell*, it gave me more trouble than I expected. All kinds of definitions are available, ranging from the simple comparison that "the shell is the steering wheel of the car", to the vague definition in the Bash manual which says that "bash is an sh-compatible command language interpreter," or an even more obscure expression, "a shell manages the interaction between the system and its users". A shell is much more than that.

A shell can best be compared with a way of talking to the computer, a language. Most users do know that other language, the click-and-point language of the desktop. But in that language the user is treated as a baby, asked to pick from what is presented to him.

The shell, on the other hand, is an advanced way of communicating with the system, because it allows for conversation and taking initiative. Both partners in the communication are equal, so new ideas can be tested. The shell allows the user to handle a system in a flexible way, and is also a means of stress reduction. Who does not appreciate being treated like an adult?

3.2.3.2.2. Shell types

Just like people know different languages and dialects, the computer knows different shell types:

- **sh** or Bourne Shell: the original shell still used on UNIX systems and in UNIX related environments. This is the basic shell, a small program with few features. When in POSIX-compatible mode, **bash** will emulate this shell.
- **bash** or Bourne Again shell: the standard GNU shell, intuitive and flexible. Probably most advisable for beginning users while being at the same time a powerful tool for the advanced and professional user. On Linux, **bash** is the standard shell for common users. This shell is a so-called *superset* of the Bourne shell, a set of add-ons and plug-ins. This means that the Bourne Again shell is compatible with the Bourne shell: commands that work in **sh**, also work in **bash**. However, the reverse is not always the case. All examples and exercises in this book use **bash**.
- **csh** or C shell: the syntax of this shell resembles that of the C programming language. Sometimes asked for by programmers.
- **tcsh** or Turbo C shell: a superset of the common C shell, enhancing user-friendliness and speed.
- **ksh** or the Korn shell: sometimes appreciated by people with a UNIX background. A superset of the Bourne shell; with standard configuration a nightmare for beginning users.

The file `/etc/shells` gives an overview of known shells on a Linux system:

```
mia:~> cat /etc/shells
/bin/bash
/bin/sh
/bin/tcsh
/bin/csh
```



Fake Bourne shell

Note that `/bin/sh` is usually a link to Bash, which will execute in Bourne shell compatible mode when called on this way.

Your default shell is set in the `/etc/passwd` file, like this line for user *mia*:

```
mia:L2NOFqdlPrHwE:504:504:Mia Maya:/home/mia:/bin/bash
```

To switch from one shell to another, just enter the name of the new shell in the active terminal. The system finds the directory where the name occurs using the `PATH` settings, and since a shell is an executable file (program), the current shell activates it and it gets executed. A new prompt is usually shown, because each shell has its typical appearance:

```
mia:~> tcsh  
[mia@post21 ~]$
```

3.2.3.2.3. Which shell am I using?

If you don't know which shell you are using, either check the line for your account in `/etc/passwd` or type the command

echo \$SHELL

3.2.3.3. Your home directory

Your home directory is your default destination when connecting to the system. In most cases it is a subdirectory of `/home`, though this may vary. Your home directory may be located on the hard disk of a remote file server; in that case your home directory may be found in `/nethome/your_user_name`. In another case the system administrator may have opted for a less comprehensible layout and your home directory may be on `/disk6/HU/07/jgillard`.

Whatever the path to your home directory, you don't have to worry too much about it. The correct path to your home directory is stored in the `HOME` environment variable, in case some program needs it. With the **echo** command you can display the content of this variable:

```
orlando:~> echo $HOME  
/nethome/orlando
```

You can do whatever you like in your home directory. You can put as many files in as many directories as you want, although the total amount of data and files is naturally limited because of the hardware and size of the partitions, and sometimes because the system administrator has applied a quota system. Limiting disk usage was common practice when hard disk space was still expensive. Nowadays, limits are almost exclusively applied in large environments. You can see for yourself if a limit is set using the **quota** command:

```
pierre@lamaison:/> quota -v  
Diskquotas for user pierre (uid 501): none
```

In case quotas have been set, you get a list of the limited partitions and their specific limitations. Exceeding the limits may be tolerated during a grace period with fewer or no restrictions at all. Detailed information can be found using the **info quota** or **man quota** commands.

Your home directory is indicated by a tilde (~), shorthand for `/path_to_home/user_name`. This same path is stored in the `HOME` variable, so you don't have to do anything to activate it. A simple application: switch from `/var/music/albums/arno/2001` to `images` in your home directory using one elegant command:

```
rom:/var/music/albums/arno/2001> cd ~/images
```

```
rom:~/images> pwd
/home/rom/images
```

Later in this chapter we will talk about the commands for managing files and directories in order to keep your home directory tidy.

3.2.4. The most important configuration files

As we mentioned before, most configuration files are stored in the `/etc` directory. Content can be viewed using the `cat` command, which sends text files to the standard output (usually your monitor). The syntax is straight forward:

```
cat file1 file2 ... fileN
```

In this section we try to give an overview of the most common configuration files. This is certainly not a complete list. Adding extra packages may also add extra configuration files in `/etc`. When reading the configuration files, you will find that they are usually quite well commented and self-explanatory. Some files also have man pages which contain extra documentation, such as `man aliases`.

Table 3–3. Most common configuration files

File	Information/service
<code>aliases</code>	Mail aliases file for use with the Sendmail mail server. Running a mail server on each and every system has long been common use in the UNIX world, and almost every Linux distribution still comes with a Sendmail package. In this file local user names are matched with real names as they occur in E-mail addresses, or with other local addresses.
<code>bashrc</code>	The system-wide configuration file for the Bourne Again SHell. Defines functions and aliases for all users. Other shells may have their own system-wide config files, like <code>bashrc</code> .
<code>crontab</code> and the <code>crontab</code> directories	Configuration of tasks that need to be executed periodically – backups, updates of the system databases, cleaning of the system, rotating logs etc.
<code>default</code>	Default options for certain commands, such as <code>useradd</code> .
<code>filesystems</code>	Known file systems: <code>ext3</code> , <code>vfat</code> , <code>iso9660</code> etc.
<code>fstab</code>	Lists partitions and their <i>mount points</i> .
<code>ftp*</code>	Configuration of the ftp-server: who can connect, what parts of the system are accessible etc.
<code>group</code>	Configuration file for user groups. Use the shadow utilities <code>groupadd</code> , <code>groupmod</code> and <code>groupdel</code> to edit this file. Edit manually only if you really know what you are doing.
<code>grub.conf</code>	Boot information.
<code>hosts</code>	A list of machines that can be contacted using the network, but without the need for a domain name service. This has nothing to do with the system's network configuration, which is done in <code>/etc/sysconfig</code> .
<code>httpd</code>	Config files for the Apache web server.

Introduction to Linux

<code>inittab</code>	Information for booting: mode, number of text consoles etc.
<code>issue</code>	Information about the distribution (release version and/or kernel info).
<code>ld.so.conf</code>	Locations of library files.
<code>lilo.conf</code> , <code>sililo.conf</code> , <code>about.conf</code> etc.	Boot information for the LInux LOader, the system for booting that was in use before Lilo changed to GRUB.
<code>logrotate.*</code>	Rotation of the logs, a system preventing the collection of huge amounts of log files.
<code>mail</code>	Directory containing instructions for the behavior of the mail server.
<code>modules.conf</code>	Configuration of modules that enable special features (drivers).
<code>motd</code>	Message Of The Day: Shown to everyone who connects to the system (in text mode), may be used by the system admin to announce system services/maintenance etc.
<code>mtab</code>	Currently mounted file systems. It is advised to never edit this file.
<code>nsswitch.conf</code>	Order in which to contact the name resolvers when a process demands resolving of a host name.
<code>pam.d</code>	Configuration of authentication modules.
<code>passwd</code>	Lists local users. Use the shadow utilities useradd , usermod and userdel to edit this file. Edit manually only when you really know what you are doing.
<code>printcap</code>	Outdated but still frequently used printer configuration file. Don't edit this manually unless you really know what you are doing.
<code>profile</code>	System wide configuration of the shell environment: variables, default properties of new files, limitation of resources etc.
<code>rc*</code>	Directories defining active services for each run level.
<code>resolv.conf</code>	Order in which to contact DNS servers (Domain Name Servers only).
<code>sendmail.cf</code>	Main config file for the Sendmail server.
<code>services</code>	Connections accepted by this machine (open ports).
<code>sndconfig</code> and <code>sound</code>	Configuration of the sound card and sound events.
<code>ssh</code>	Directory containing the config files for secure shell client and server.
<code>sysconfig</code>	Directory containing the system configuration files: mouse, keyboard, network, desktop, system clock, power management etc. (specific to RedHat)
<code>X11</code>	Settings for the graphical server, X. RedHat uses XFree, which is reflected in the name of the main configuration file, XFree86Config. Also contains the general directions for the window managers available on the system, for example gdm , fvwm , twm , etc.
<code>xinetd.*</code>	Configuration files for Internet services that are run from the system's (extended) Internet services daemon (servers that don't run an independent daemon).

Throughout this guide we will learn more about these files and study some of them in detail.

3.2.5. The most common devices

Devices, generally every peripheral attachment of a PC that is not the CPU itself, is presented to the system as an entry in the `/dev` directory. One of the advantages of this UNIX-way of handling devices is that neither the user nor the system has to worry much about the specification of devices.

Users that are new to Linux or UNIX in general are often overwhelmed by the amount of new names and concepts they have to learn. That is why a list of common devices is included in this introduction.

Table 3–4. Common devices

Name	Device
<code>cdrom</code>	CD drive
<code>console</code>	Special entry for the currently used console.
<code>cua*</code>	Serial ports
<code>dsp*</code>	Devices for sampling and recording
<code>fd*</code>	Entries for most kinds of floppy drives, the default is <code>/dev/fd0H1440</code> , a floppy drive for 1.44 MB floppies.
<code>hd[a-t][1-16]</code>	Standard support for IDE drives with maximum amount of partitions each.
<code>ir*</code>	Infrared devices
<code>isdn*</code>	Management of ISDN connections
<code>js*</code>	Joystick(s)
<code>lp*</code>	Printers
<code>mem</code>	Memory
<code>midi*</code>	midi player
<code>mixer* and music</code>	Idealized model of a mixer (combines or adds signals)
<code>modem</code>	Modem
<code>mouse</code> (also <code>msmouse</code> , <code>logimouse</code> , <code>psmouse</code>)	All kinds of mouses
<code>null</code>	Bottomless garbage can
<code>par*</code>	Entries for parallel port support
<code>pty*</code>	Pseudo terminals
<code>radio*</code>	For Radio Amateurs (HAMs).
<code>ram*</code>	boot device
<code>sd*</code>	SCSI disks with their partitions
<code>sequencer</code>	For audio applications using the synthesizer features of the sound card (MIDI-device controller)
<code>tty*</code>	Virtual consoles simulating vt100 terminals.
<code>usb*</code>	USB card and scanner
<code>video*</code>	For use with a graphics card supporting video.

3.2.6. The most common variable files

In the `/var` directory we find a set of directories for storing specific non-constant data (as opposed to the `ls` program or the system configuration files, which change relatively infrequently or never at all). All files that change frequently, such as log files, mailboxes, lock files, spoolers etc. are kept in a subdirectory of `/var`.

As a security measure these files are usually kept in separate parts from the main system files, so we can keep a close eye on them and set stricter permissions where necessary. A lot of these files also need more permissions than usual, like `/var/tmp`, which needs to be writable for everyone. A lot of user activity might be expected here, which might even be generated by anonymous Internet users connected to your system. This is one reason why the `/var` directory, including all its subdirectories, is usually on a separate partition. This way, there is for instance no risk that a mail bomb, for instance, fills up the rest of the file system, containing more important data such as your programs and configuration files.

`/var/tmp` and `/tmp`

Files in `/tmp` can be deleted without notice, by regular system tasks or because of a system reboot. On some (customized) systems, also `/var/tmp` might behave unpredictably. Nevertheless, since this is not the case by default, we advise to use the `/var/tmp` directory for saving temporary files. When in doubt, check with your system administrator. If you manage your own system, you can be reasonably sure that this is a safe place if you did not consciously change settings on `/var/tmp` (as root, a normal user can not do this).

Whatever you do, try to stick to the privileges granted to a normal user – don't go saving files directly under the root (`/`) of the file system, don't put them in `/usr` or some subdirectory or in another reserved place. This pretty much limits your access to safe file systems.

One of the main security systems on a UNIX system, which is naturally implemented on every Linux machine as well, is the log-keeping facility, which logs all user actions, processes, system events etc. The configuration file of the so-called *syslogd* daemon determines which and how long logged information will be kept. The default location of all logs is `/var/log`, containing different files for access log, server logs, system messages etc.

In `/var` we typically find server data, which is kept here to separate it from critical data such as the server program itself and its configuration files. A typical example on Linux systems is `/var/www`, which contains the actual HTML pages, scripts and images that a web server offers. The FTP-tree of an FTP server (data that can be downloaded by a remote client) is also best kept in one of `/var`'s subdirectories. Because this data is publicly accessible and often changeable by anonymous users, it is safer to keep it here, away from partitions or directories with sensitive data.

On most workstation installations, `/var/spool` will at least contain an `at` and a `cron` directory, containing scheduled tasks. In office environments this directory usually contains `lpd` as well, which holds the print queue(s) and further printer configuration files, as well as the printer log files.

On server systems we will generally find `/var/spool/mail`, containing incoming mails for local users, sorted in one file per user, the user's "inbox". A related directory is `mqueue`, the spooler area for unsent mail messages. These parts of the system can be very busy on mail servers with a lot of users. News servers also use the `/var/spool` area because of the enormous amounts of messages they have to process.

The `/var/lib/rpm` directory is specific to RPM-based (RedHat Package Manager) distributions; it is where RPM package information is stored.

3.3. Manipulating files

3.3.1. Viewing file properties

3.3.1.1. More about ls

Besides the name of the file, **ls** can give a lot of other information, such as the file type, as we already discussed. It can also show permissions on a file, file size, inode number, creation date and time, owners and amount of links to the file. With the `-a` option to **ls**, files that are normally hidden from view can be displayed as well. These are files that have a name starting with a dot. A couple of typical examples include the configuration files in your home directory. When you've worked with a certain system for a while, you will notice that tens of files and directories have been created that are not automatically listed in a directory index. Next to that, every directory contains a file named just dot (`.`) and one with two dots (`..`), which are used in combination with their inode number to determine the directory's position in the file system's tree structure.

You should really read the Info pages about **ls**, since it is a very common command with a lot of useful options. Options can be combined, as is the case with most UNIX commands and their options. A common combination is **ls -al**; it shows a long list of files and their properties as well as the destinations that any symbolic links point to. **ls -ltr** displays the same files, only now in reversed order of the last change, so that the file changed most recently occurs at the bottom of the list. Here are a couple of examples:

```
krissie:~/mp3> ls
Albums/  Radio/  Singles/  gene/  index.html

krissie:~/mp3> ls -a
./      .thumbs  Radio     gene/
../     Albums/  Singles/  index.html

krissie:~/mp3> ls -l Radio/
total 8
drwxr-xr-x  2 krissie krissie 4096 Oct 30  1999 Carolina/
drwxr-xr-x  2 krissie krissie 4096 Sep 24  1999 Slashdot/

krissie:~/mp3> ls -ld Radio/
drwxr-xr-x  4 krissie krissie 4096 Oct 30  1999 Radio/

krissie:~/mp3> ls -ltr
total 20
drwxr-xr-x  4 krissie krissie 4096 Oct 30  1999 Radio/
-rw-r--r--  1 krissie krissie  453 Jan  7  2001 index.html
drwxrwxr-x 30 krissie krissie 4096 Oct 20 17:32 Singles/
drwxr-xr-x  2 krissie krissie 4096 Dec  4 23:22 gene/
drwxrwxr-x 13 krissie krissie 4096 Dec 21 11:40 Albums/
```

On most Linux versions **ls** is *aliased* to `color-ls` by default. This feature allows to see the file type without using any options to **ls**. To achieve this, every file type has its own color. The standard scheme is in `/etc/DIR_COLORS`:

Table 3–5. Color-ls default color scheme

Color	File type
-------	-----------

blue	directories
red	compressed archives
white	text files
pink	images
cyan	links
yellow	devices
green	executables
flashing red	broken links

More information is in the man page. The same information was in earlier days displayed using suffixes to every non-standard file name. For mono-color use (like printing a directory listing) and for general readability, this scheme is still in use:

Table 3–6. Default suffix scheme for ls

Character	File type
nothing	regular file
/	directory
*	executable file
@	link
=	socket
	named pipe

A description of the full functionality and features of the **ls** command can be read with **info ls**.

3.3.1.2. More tools

To find out more about the kind of data we are dealing with, we use the **file** command. By applying certain tests that check properties of a file in the file system, magic numbers and language tests, **file** tries to make an educated guess about the format of a file. Some examples:

```
mike:~> file Documents/
Documents/: directory

mike:~> file high-tech-stats.pdf
high-tech-stats.pdf: PDF document, version 1.2

mike:~> file Nari-288.rm
Nari-288.rm: RealMedia file

mike:~> file bijlage10.sdw
bijlage10.sdw: Microsoft Office Document

mike:~> file logo.xcf
logo.xcf: GIMP XCF image data, version 0, 150 x 38, RGB Color

mike:~> file cv.txt
cv.txt: ISO-8859 text

mike:~> file image.png
```

```

image.png: PNG image data, 616 x 862, 8-bit grayscale, non-interlaced

mike:~> file figure
figure: ASCII text

mike:~> file me+tux.jpg
me+tux.jpg: JPEG image data, JFIF standard 1.01, resolution (DPI),
           "28 Jun 1999", 144 x 144

mike:~> file 42.zip.gz
42.zip.gz: gzip compressed data, deflated, original filename,
           `42.zip', last modified: Thu Nov  1 23:45:39 2001, os: Unix

mike:~> file vi.gif
vi.gif: GIF image data, version 89a, 88 x 31

mike:~> file slidel
slidel: HTML document text

mike:~> file template.xls
template.xls: Microsoft Office Document

mike:~> file abook.ps
abook.ps: PostScript document text conforming at level 2.0

mike:~> file /dev/log
/dev/log: socket

mike:~> file /dev/hda
/dev/hda: block special (3/0)

```

The **file** command has a series of options, among others the `-z` option to look into compressed files. See **info file** for a detailed description. Keep in mind that the results of **file** are not absolute, it is only a guess. In other words, **file** can be tricked.



Why all the fuss about file types and formats?

Shortly, we will discuss a couple of command-line tools for looking at *plain text files*. These tools will not work when used on the wrong type of files. In the worst case, they will crash your terminal and/or make a lot of beeping noises. If this happens to you, just close the terminal session and start a new one. But try to avoid it, because it is usually very disturbing for other people.

3.3.2. Creating and deleting files and directories

3.3.2.1. Making a mess...

... Is not a difficult thing to do. Today almost every system is networked, so naturally files get copied from one machine to another. And especially when working in a graphical environment, creating new files is a piece of cake and is often done without the approval of the user. To illustrate the problem, here's the full content of a new user's directory, created on a standard RedHat system:

```

[newuser@blob user]$ ls -al
total 32
drwx-----  3 user      user      4096 Jan 16 13:32 .
drwxr-xr-x   6 root      root      4096 Jan 16 13:32 ..
-rw-r--r--   1 user      user       24 Jan 16 13:32 .bash_logout
-rw-r--r--   1 user      user     191 Jan 16 13:32 .bash_profile

```



```
-rw-r--r--  1 user      user      124 Jan 16 13:32 .bashrc
drwxr-xr-x  3 user      user     4096 Jan 16 13:32 .kde
-rw-r--r--  1 user      user     3511 Jan 16 13:32 .screenrc
-rw-----  1 user      user       61 Jan 16 13:32 .xauthDqztLr
```

On first sight, the content of a "used" home directory doesn't look that bad either:

```
olduser:~> ls
app-defaults/  crossover/    Fvwm@        mp3/          OpenOffice.org638/
articles/      Desktop/     GNUstep/     Nautilus/     staroffice6.0/
bin/           Desktop1/    images/      nqc/          training/
bro1/          desktoptest/ Machines@    ns_imap/      webstart/
C/             Documents/   mail/        nsmail/       xml/
closed/        Emacs@       Mail/        office52/     Xrootenv.0
```

But when all the directories and files starting with a dot are included, there are 185 items in this directory. This is because most applications have their own directories and/or files, containing user-specific settings, in the home directory of that user. Usually these files are created the first time you start an application. In some cases you will be notified when a non-existent directory needs to be created, but most of the time everything is done automatically.

Furthermore, new files are created seemingly continuously because users want to save files, keep different versions of their work, use Internet applications, and download files and attachments to their local machine. It doesn't stop. It is clear that one definitely needs a scheme to keep an overview on things.

In the next section, we will discuss our means of keeping order. We only discuss text tools available to the shell, since the graphical tools are very intuitive and have the same look and feel as the well known point-and-click MS Windows-style file managers, including graphical help functions and other features you expect from this kind of applications. The following list is an overview of the most popular file managers for GNU/Linux. Most file managers can be started from the menu of your desktop manager, or by clicking your home directory icon, or from the command line, issuing these commands:

- **nautilus**: The default file manager in Gnome, the GNU desktop. Excellent documentation about working with this tool can be found at <http://www.gnome.org>.
- **konqueror**: The file manager typically used on a KDE desktop. The handbook is at <http://docs.kde.org>.
- **mc**: Midnight Commander, the Unix file manager after the fashion of Norton Commander. All documentation available from <http://gnu.org/directory/> or a mirror, such as <http://www.ibiblio.org>.

These applications are certainly worth giving a try and usually impress newcomers to Linux, if only because there is such a wide variety: these are only the most popular tools for managing directories and files, and many other projects are being developed. Now let's find out about the internals and see how these graphical tools use common UNIX commands.

3.3.2.2. The tools

3.3.2.2.1. Creating directories

A way of keeping things in place is to give certain files specific default locations by creating directories and subdirectories (or folders and sub-folders if you wish). This is done with the **mkdir** command:

```
richard:~> mkdir archive
```

```
richard:~> ls -ld archive
drwxrwxrwx 2 richard richard          4096 Jan 13 14:09 archive/
```

Creating directories and subdirectories in one step is done using the `-p` option:

```
richard:~> cd archive

richard:~/archive> mkdir 1999 2000 2001

richard:~/archive> ls
1999/ 2000/ 2001/

richard:~/archive> mkdir 2001/reports/Restaurants-Michelin/
mkdir: cannot create directory `2001/reports/Restaurants-Michelin/':
No such file or directory

richard:~/archive> mkdir -p 2001/reports/Restaurants-Michelin/

richard:~/archive> ls 2001/reports/
Restaurants-Michelin/
```

If the new file needs other permissions than the default file creation permissions, the new access rights can be set in one move, still using the `mkdir` command, see the Info pages for more. We are going to discuss access modes in the next section on File Security.

The name of a directory has to comply with the same rules as those applied on regular file names. One of the most important restrictions is that you can't have two files with the same name in one directory (but keep in mind that Linux is, like UNIX, a case sensitive operating system). There are virtually no limits on the length of a file name, but it is usually kept shorter than 80 characters, so it can fit on one line of a terminal. You can use any character you want in a file name, although it is advised to exclude characters that have a special meaning to the shell. When in doubt, check with [Appendix C](#).

3.3.2.2. Moving files

Now that we have properly structured our home directory, it is time to clean up unclassified files using the `mv` command:

```
richard:~/archive> mv ../report[1-4].doc reports/Restaurants-Michelin/
```

This command is also applicable when renaming files:

```
richard:~> ls To_Do
-rw-rw-r-- 1 richard richard    2534 Jan 15 12:39 To_Do

richard:~> mv To_Do done

richard:~> ls -l done
-rw-rw-r-- 1 richard richard    2534 Jan 15 12:39 done
```

It is clear that only the name of the file changes. All other properties remain the same.

Detailed information about the syntax and features of the `mv` command can be found in the man or Info pages. The use of this documentation should always be your first reflex when confronted with a problem. The answer to your problem is likely to be in the system documentation. Even experienced users read man pages every

day, so beginning users should read them all the time. After a while, you will get to know the most common options to the common commands, but you will still need the documentation as a primary source of information. Note that the information contained in the HOWTOs, FAQs, man pages and such is slowly being merged into the Info pages, which are today the most up-to-date source of online (as in readily available on the system) documentation.

3.3.2.2.3. Copying files

Copying files and directories is done with the **cp** command. A useful option is recursive copy (copy all underlying files and subdirectories), using the **-R** option to **cp**. The general syntax is

cp [-R] fromfile tofile

As an example the case of user *newguy*, who wants the same Gnome desktop settings user *oldguy* has. One way to solve the problem is to copy the settings of *oldguy* to the home directory of *newguy*:

```
victor:~> cp -R ../oldguy/.gnome/ .
```

This gives some errors involving file permissions, but all the errors have to do with private files that *newguy* doesn't need anyway. We will discuss in the next part how to change these permissions in case they really are a problem.

3.3.2.2.4. Removing files

Use the **rm** command to remove single files, **rmdir** to remove empty directories. (Use **ls -a** to check whether a directory is empty or not). The **rm** command also has options for removing non-empty directories with all their subdirectories, read the Info pages for these rather dangerous options.

How empty can a directory be?

It is normal that the directories **.** (dot) and **..** (dot-dot) can't be removed, since they are also necessary in an empty directory to determine the directories ranking in the file system hierarchy.

On Linux, just like on UNIX, there is no garbage can – at least not for the shell, although there are plenty of solutions for graphical use. So once removed, a file is really gone, and there is generally no way to get it back unless you have backups, or you are really fast and have a real good system administrator. To protect the beginning user from this malice, the interactive behavior of the **rm**, **cp** and **mv** commands can be activated using the **-i** option. In that case the system won't immediately act upon request. Instead it will ask for confirmation, so it takes an additional click on the **Enter** key to inflict the damage:

```
mary:~> rm -ri archive/
rm: descend into directory `archive'? y
rm: descend into directory `archive/reports'? y
rm: remove directory `archive/reports'? y
rm: descend into directory `archive/backup'? y
rm: remove `archive/backup/sysbup200112.tar'? y
rm: remove directory `archive/backup'? y
rm: remove directory `archive'? y
```

We will discuss how to make this option the default in [Chapter 7](#), which discusses customizing your shell environment.

3.3.3. Finding files

3.3.3.1. Using shell features

In the example on moving files we already saw how the shell can manipulate multiple files at once. In that example, the shell finds out automatically what the user means by the requirements between the square braces "[" and "]". The shell can substitute ranges of numbers and upper or lower case characters alike. It also substitutes as many characters as you want with an asterisk, and only one character with a question mark.

All sorts of substitutions can be used simultaneously; the shell is very logical about it. The Bash shell, for instance, has no problem with expressions like `ls dirname/*/*/*[2-3]`.

In other shells, the asterisk is commonly used to minimize the efforts of typing: people would enter `cd dir*` instead of `cd directory`. In Bash however, this is not necessary because the GNU shell has a feature called file name completion. It means that you can type the first few characters of a command (anywhere) or a file (in the current directory) and if no confusion is possible, the shell will find out what you mean. For example in a directory containing many files, you can check if there are any files beginning with the letter A just by typing `ls A` and pressing the **Tab** key twice, rather than pressing **Enter**. If there is only one file starting with "A", this file will be shown as the argument to `ls` (or any shell command, for that matter) immediately.

3.3.3.2. Which

A very simple way of looking up files is using the **which** command, to look in the directories listed in the user's search path for the required file. Of course, since the search path contains only paths to directories containing executable programs, **which** doesn't work for ordinary files. The **which** command is useful when troubleshooting "Command not Found" problems. In the example below, user *tina* can't use the **acroread** program, while her colleague has no troubles whatsoever on the same system. The problem is similar to the PATH problem in the previous part: Tina's colleague tells her that he can see the required program in `/opt/acroread/bin`, but this directory is not in her path:

```
tina:~> which acroread
/usr/bin/which: no acroread in (/bin:/usr/bin:/usr/bin/X11)
```

The problem can be solved by giving the full path to the command to run, or by re-exporting the content of the PATH variable:

```
tina:~> export PATH=$PATH:/opt/acroread/bin

tina:~> echo $PATH
/bin:/usr/bin:/usr/bin/X11:/opt/acroread/bin
```

Using the **which** command also checks to see if a command is an alias for another command:

```
gerrit:~> which -a ls
ls is aliased to `ls -F --color=auto'
ls is /bin/ls

gerrit:~> which -a which
which is aliased to `type'
which is /usr/bin/which

gerrit:~> which type
type is a shell builtin
```

This actually means that **which** is built-in in the shell, but that there is also a **which** "stand alone version". The shell built-in version precedes the **which** in `/usr/bin`, which is still there for compatibility with UNIX.

3.3.3.3. Find and locate

These are the real tools, used when searching other paths beside those listed in the search path. The **find** tool, known from UNIX, is very powerful, which may be the cause of a somewhat more difficult syntax. GNU **find**, however, deals with the syntax problems. This command not only allows you to search file names, it can also accept file size, date of last change and other file properties as criteria for a search. The most common use is for finding file names:

```
find <path> -name <searchstring>
```

This can be interpreted as "Look in all files and subdirectories contained in a given path, and print the names of the files containing the search string in their name" (not in their content).

Another application of **find** is for searching files of a certain size, as in the example below, where user *peter* wants to find all files in the current directory or one of its subdirectories, that are bigger than 5 MB:

```
peter:~> find . -size +5000k
psychotic_chaos.mp3
```

If you dig in the man pages, you will see that **find** can also perform operations on the found files. A common example is removing files. It is best to first test without the `-exec` option that the correct files are selected, after that the command can be rerun to delete the selected files. Below, we search for files ending in `.tmp`:

```
peter:~> find . -name "*.tmp" -exec rm {} \;
peter:~>
```

Optimize!

This command will call on **rm** as many times as a file answering the requirements is found. In the worst case, this might be thousands or millions of times. This is quite a load on your system.

A more realistic way of working would be the use of a pipe (`|`) and the **xargs** tool with **rm** as an argument. This way, the **rm** command is only called when the command line is full, instead of for every file. See [Chapter 5](#) for more on using I/O redirection to ease everyday tasks.

Later on (in 1999 according to the man pages, after 20 years of **find**), **locate** was developed. This program is easier to use, but more restricted than **find**, since its output is based on a file index database that is updated only once every day. On the other hand, a search in the **locate** database is less time- and CPU-consuming than a search with **find**.

Most Linux distributions use **slocate** these days, security enhanced locate, the modern version of **locate** that prevents users from getting output they have no right to read. The files in *root*'s home directory are such an example, these are not normally accessible to the public. A user who wants to find someone who knows about the C-shell may issue the command **locate .cshrc**, to display all users who have a customized configuration file for the C shell. Supposing the users *root* and *jenny* are running C shell, then only the file `/home/jenny/.cshrc` will be displayed, and not the one in *root*'s home directory. On most systems,

locate is a symbolic link to the **slocate** program:

```
billy:~> ls -l /usr/bin/locate
lrwxrwxrwx 1 root slocate 7 Oct 28 14:18 /usr/bin/locate -> slocate*
```

User *tina* could have used **locate** to find the application she wanted:

```
tina:~> locate acroread
/usr/share/icons/hicolor/16x16/apps/acroread.png
/usr/share/icons/hicolor/32x32/apps/acroread.png
/usr/share/icons/loicolor/16x16/apps/acroread.png
/usr/share/icons/loicolor/32x32/apps/acroread.png
/usr/local/bin/acroread
/usr/local/Adobe/Reader/intellinux/bin/acroread
/usr/local/Adobe/bin/acroread
```

Directories that don't contain the name `bin` can't contain the program – they don't contain executable files. There are three possibilities left. The file in `/usr/local/bin` is the one *tina* would have wanted: it is a link to the shell script that starts the actual program:

```
tina:~> file /usr/local/bin/acroread
/usr/local/bin/acroread: symbolic link to ../Acrobat4/bin/acroread

tina:~> file /usr/local/Adobe/bin/acroread
/usr/local/Adobe/bin/acroread: Bourne shell script text executable

tina:~> file /usr/local/Adobe/Reader/intellinux/bin/acroread
/usr/local/Adobe/Reader/intellinux/bin/acroread: ELF 32-bit LSB
executable, Intel 80386, version 1, dynamically linked (uses
shared libs), not stripped
```

In order to keep the path as short as possible, so the system doesn't have to search too long every time a user wants to execute a command, we add `/usr/local/bin` to the path and not the other directories, which only contain the binary files of one specific program, while `/usr/local/bin` contains other useful programs as well.

Again, a description of the full features of **find** and **locate** can be found in the Info pages.

3.3.3.4. The **grep** command

3.3.3.4.1. General line filtering

A simple but powerful program, **grep** is used for filtering input lines and returning certain patterns to the output. There are literally thousands of applications for the **grep** program. In the example below, *jerry* uses **grep** to see how he did the thing with **find**:

```
jerry:~> grep -a find .bash_history
find . -name userinfo
man find
find ../ -name common.cfg
```

Search history

Also useful in these cases is the search function in **bash**, activated by pressing **Ctrl+R** at once, such as in the example where we want to check how we did that last **find** again:

Introduction to Linux

```
thomas ~-> ^R
(reverse-i-search)`find': find `/home/thomas` -name *.xml
```

Type your search string at the search prompt. The more characters you type, the more restricted the search gets. This reads the command history for this shell session (which is written to `.bash_history` in your home directory when you quit that session). The most recent occurrence of your search string is shown. If you want to see previous commands containing the same string, type **Ctrl+R** again.

See the Info pages on **bash** for more.

All UNIXes with just a little bit of decency have an online dictionary. So does Linux. The dictionary is a list of known words in a file named `words`, located in `/usr/share/dict`. To quickly check the correct spelling of a word, no graphical application is needed:

```
william:~> grep penguin /usr/share/dict/words
william:~> grep penguin /usr/share/dict/words
penguin
penguins
```

Who is the owner of that home directory next to mine? Hey, there's his telephone number!

```
lisa:~> grep gdbruyne /etc/passwd
gdbruyne:x:981:981:Guy Debruyne, tel 203234:/home/gdbruyne:/bin/bash
```

And what was the E-mail address of Arno again?

```
serge:~/mail> grep -i arno *
sent-mail: To: <Arno.Hintjens@celeb.com>
sent-mail: On Mon, 24 Dec 2001, Arno.Hintjens@celeb.com wrote:
```

find and **locate** are often used in combination with **grep** to define some serious queries. For more information, see [Chapter 5](#) on I/O redirection.

3.3.3.4.2. Special characters

Characters that have a special meaning to the shell have to be *escaped*. The escape character in Bash is backslash, as in most shells; this takes away the special meaning of the following character. The shell knows about quite some special characters, among the most common `/`, `.`, `?` and `*`. A full list can be found in the Info pages and documentation for your shell. For instance, say that you want to display the lines containing "searchstring*" (where `*` matches the asterisk character) instead of any lines containing the string "searchstring"* (where `*` matches any amount of any character), you issue the command

```
grep "searchstring\*" file(s)
```

Finding the string "e.g." in a file will report all lines containing any character in the second and forth position of the search string. If you escape the dots, you will find the occurrences of the string representing the abbreviation for "example given":

```
grep "e\.g\." file
```

More in the **grep** Info pages.

3.3.4. More ways to view file content

3.3.4.1. General

Apart from **cat**, which really doesn't do much more than sending files to the standard output, there are other tools to view file content.

The easiest way of course would be to use graphical tools instead of command line tools. In the introduction we already saw a glimpse of an office application, OpenOffice. Other examples are the GIMP (start up with **gimp** from the command line), the GNU Image Manipulation Program; **xpdf** to view Portable Document Format files (PDF); GhostView (**gv**) for viewing PostScript files; the Mozilla Project, **links** (a text mode browser), Konqueror, Opera and many others for web content; XMMS, CDplay and others for multi-media file content; AbiWord, Gnumeric, KOffice etc. for all kinds of office applications and so on. There are thousands of Linux applications; to list them all would take days.

Instead we keep concentrating on shell- or text-mode applications, which form the basics for all other applications. These commands work best in a text environment on files containing text. When in doubt, check first using the **file** command.

So let's see what text tools we have that are useful to look inside files.



Font problems

Plain text tools such as the ones we will now be discussing, often have problems with "plain" text files because of the font encoding used in those files. Special characters, such as accented alphabetical characters, Chinese characters and other characters from languages using different character sets than the default *en_US* encoding and so on, are then displayed the wrong way or replaced by unreadable rubbish. These problems are discussed in [Section 7.5](#).

3.3.4.2. "less is more"

Undoubtedly you will hear someone say this phrase sooner or later when working in a UNIX environment. A little bit of UNIX history explains this:

- First there was **cat**. Output was streamed in an uncontrollable way.
- Then there was **pg**, which may still be found on older UNIXes. This command puts text to the output one page at the time.
- The **more** program was a revised version of **pg**. This command is still available on every Linux system.
- **less** is the GNU version of more and has extra features allowing highlighting of search strings, scrolling back etc. The syntax is very simple:

less file

More information is located in the Info pages.

3.3.4.3. Head and tail

These two commands display the *n* first/last lines of a file respectively. To see the last ten commands entered:

```
tony:~> tail -10 .bash_history
locate configure | grep bin
man bash
cd
xawtv &
grep usable /usr/share/dict/words
grep advisable /usr/share/dict/words
info quota
man quota
echo $PATH
frm
```

head works similarly. The **tail** command has a handy feature to continuously show the last *n* lines of a file that changes all the time. This `-f` option is often used by system administrators to check on log files. More information is located in the system documentation files.

3.3.5. Linking files

3.3.5.1. Link types

Since we know more about files and their representation in the file system, understanding links (or shortcuts) is a piece of cake. A link is nothing more than a way of matching two or more file names to the same set of file data. There are two ways to achieve this:

- **Hard link:** Associate two or more file names with the same inode. Hard links share the same data blocks on the hard disk, while they continue to behave as independent files.

There is an immediate disadvantage: hard links can't span partitions, because inode numbers are only unique within a given partition.

- **Soft link or symbolic link (or for short: symlink):** a small file that is a pointer to another file. A symbolic link contains the path to the target file instead of a physical location on the hard disk. Since inodes are not used in this system, soft links can span across partitions.

The two link types behave similar, but are not the same, as illustrated in the scheme below:

Figure 3–2. Hard and soft link mechanism

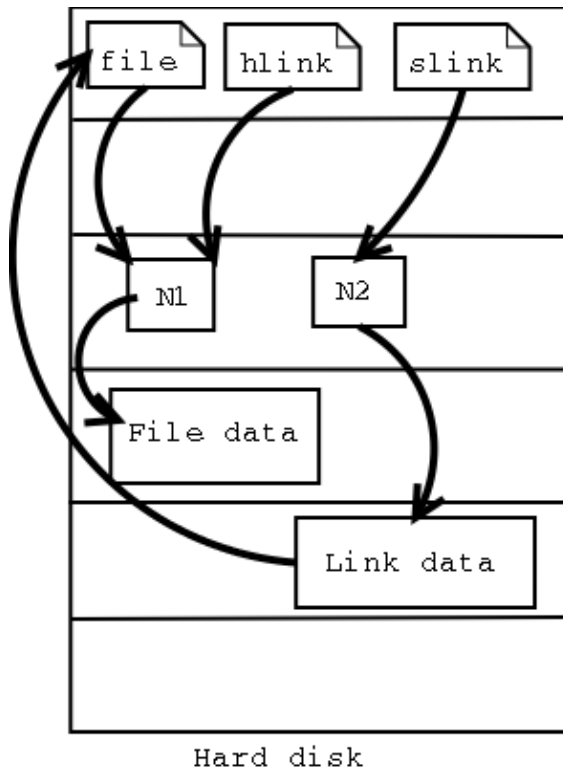

Note that removing the target file for a symbolic link makes the link useless.

Each regular file is principally a hardlink. Hardlinks can not span across partitions, since they refer to inodes, and inode numbers are only unique within a given partition.

It may be argued that there is a third kind of link, the *user-space* link, which is similar to a shortcut in MS Windows. These are files containing meta-data which can only be interpreted by the graphical file manager. To the kernel and the shell these are just normal files. They may end in a *.desktop* or *.lnk* suffix; an example can be found in `~/ .gnome-desktop`:

```
[dupont@boulot .gnome-desktop]$ cat La\ Maison\ Dupont
[Desktop Entry]
Encoding=Legacy-Mixed
Name=La Maison Dupont
Type=X-nautilus-home
X-Nautilus-Icon=temp-home
URL=file:///home/dupont
```

This example is from a KDE desktop:

```
[lena@venus Desktop]$ cat camera
[Desktop Entry]
Dev=/dev/sda1
FSType=auto
Icon=memory
MountPoint=/mnt/camera
Type=FSDevice
X-KDE-Dynamic-Device=true
```

Creating this kind of link is easy enough using the features of your graphical environment. Should you need

help, your system documentation should be your first resort.

In the next section, we will study the creation of UNIX–style symbolic links using the command line.

3.3.5.2. Creating symbolic links

The symbolic link is particularly interesting for beginning users: they are fairly obvious to see and you don't need to worry about partitions.

The command to make links is **ln**. In order to create symlinks, you need to use the **-s** option:

ln -s targetfile linkname

In the example below, user *freddy* creates a link in a subdirectory of his home directory to a directory on another part of the system:

```
freddy:~/music> ln -s /opt/mp3/Queen/ Queen
freddy:~/music> ls -l
lrwxrwxrwx 1 freddy freddy 17 Jan 22 11:07 Queen -> /opt/mp3/Queen
```

Symbolic links are always very small files, while hard links have the same size as the original file.

The application of symbolic links is widespread. They are often used to save disk space, to make a copy of a file in order to satisfy installation requirements of a new program that expects the file to be in another location, they are used to fix scripts that suddenly have to run in a new environment and can generally save a lot of work. A system admin may decide to move the home directories of the users to a new location, *disk2* for instance, but if he wants everything to work like before, like the */etc/passwd* file, with a minimum of effort he will create a symlink from */home* to the new location */disk2/home*.

3.4. File security

3.4.1. Access rights: Linux's first line of defense

The Linux security model is based on the one used on UNIX systems, and is as rigid, and in some cases even more, as the UNIX security model, which is already quite robust. On a Linux system, every file is owned by a user and a group user. There is also a third category of users, those that are not the user owner and don't belong to the group owning the file. For each category of users, read, write and execute permissions can be granted or denied.

We already used the *long* option to list files using the **ls -l** command, though for other reasons. This command also displays file permissions for these three user categories; they are indicated by the nine characters that follow the first character, which is the file type indicator at the beginning of the file properties line. As seen in the examples below, the first three characters in this series of nine display access rights for the actual user that owns the file. The next three are for the group owner of the file, the last three for other users. The permissions are always in the same order: read, write, execute for the user, the group and the others. Some examples:

```
marise:~> ls -l To_Do
-rw-rw-r-- 1 marise users 5 Jan 15 12:39 To_Do
marise:~> ls -l /bin/ls
```

```
-rwxr-xr-x  1 root  root  45948 Aug  9 15:01 /bin/ls*
```

The first file is a regular file (first dash). Users with user name *marise* or users belonging to the group *users* can read and write (change/move/delete) the file, but they can't execute it (second and third dash). All other users are only allowed to read this file, but they can't write or execute it (fourth and fifth dash).

The second example is an executable file, the difference: everybody can run this program, but you need to be *root* to change it.

The Info pages explain how the **ls** command handles display of access rights in detail, see the section *What information is listed*.

For easy use with commands, both access rights or modes and user groups have a code. See the tables below.

Table 3–7. Access mode codes

Code	Meaning
0 or –	The access right that is supposed to be on this place is not granted.
4 or r	read access is granted to the user category defined in this place
2 or w	write permission is granted to the user category defined in this place
1 or x	execute permission is granted to the user category defined in this place

Table 3–8. User group codes

Code	Meaning
u	user permissions
g	group permissions
o	permissions for others

This straight forward scheme is applied very strictly, which allows a high level of security even without network security. Among other functions, the security scheme takes care of user access to programs, it can serve files on a need-to-know basis and protect sensitive data such as home directories and system configuration files.

You should know what your user name is. If you don't, it can be displayed using the **id** command, which also displays the default group you belong to and eventually other groups of which you are a member:

```
tilly:~> id
uid=504(tilly) gid=504(tilly) groups=504(tilly),100(users),2051(org)
```

Your user name is also stored in the environment variable **USER**:

```
tilly:~> echo $USER
tilly
```

3.4.2. The tools

3.4.2.1. The chmod command

A normal consequence of applying strict file permissions, and sometimes a nuisance, is that access rights will need to be changed for all kinds of reasons. We use the **chmod** command to do this, and eventually *to chmod* has become an almost acceptable English verb, meaning the changing of the access mode of a file. The **chmod** command can be used with alphanumeric or numeric options, whatever you like best.

The example below uses alphanumeric options in order to solve a problem that commonly occurs with new users:

```

asim:~> ./hello
bash: ./hello: bad interpreter: Permission denied

asim:~> cat hello
#!/bin/bash
echo "Hello, World"

asim:~> ls -l hello
-rw-rw-r--  1 asim  asim  32 Jan 15 16:29 hello

asim:~> chmod u+x hello

asim:~> ./hello
Hello, World

asim:~> ls -l hello
-rwxrw-r--  1 asim  asim  32 Jan 15 16:29 hello*

```

The + and – operators are used to grant or deny a given right to a given group. Combinations separated by commas are allowed. The Info and man pages contain useful examples. Here's another one, which makes the file from the previous example a private file to user *asim*:

```

asim:~> chmod u+rw,go-rwx hello

asim:~> ls -l hello
-rwx-----  1 asim  asim  32 Jan 15 16:29 hello*

```

The kind of problem resulting in an error message saying that permission is denied somewhere is usually a problem with access rights in most cases. Also, comments like, "It worked yesterday," and "When I run this as root it works," are most likely caused by the wrong file permissions.

When using **chmod** with numeric arguments, the values for each granted access right have to be counted together per group. Thus we get a 3–digit number, which is the symbolic value for the settings **chmod** has to make. The following table lists the most common combinations:

Table 3–9. File protection with chmod

Command	Meaning
chmod 400 file	To protect a file against accidental overwriting.
chmod 500 directory	To protect yourself from accidentally removing, renaming or moving files

	from this directory.
chmod 600 file	A private file only changeable by the user who entered this command.
chmod 644 file	A publicly readable file that can only be changed by the issuing user.
chmod 660 file	Users belonging to your group can change this files, others don't have any access to it at all.
chmod 700 file	Protects a file against any access from other users, while the issuing user still has full access.
chmod 755 directory	For files that should be readable and executable by others, but only changeable by the issuing user.
chmod 775 file	Standard file sharing mode for a group.
chmod 777 file	Everybody can do everything to this file.

If you enter a number with less than three digits as an argument to **chmod**, omitted characters are replaced with zeros starting from the left. There is actually a fourth digit on Linux systems, that precedes the first three and sets special access modes. Everything about these and many more are located in the Info pages.

3.4.2.2. The file mask

When a new file is saved somewhere, it is first subjected to the standard security procedure. Files without permissions don't exist on Linux. The standard file permission is determined by the *mask* for new file creation. The value of this mask can be displayed using the **umask** command:

```
bert:~> umask
0002
```

Instead of adding the symbolic values to each other, as with **chmod**, for calculating the permission on a new file they need to be subtracted from the total possible access rights. In the example above, however, we see 4 values displayed, yet there are only 3 permission categories: *user*, *group* and *other*. The first zero is part of the special file attributes settings, which we will discuss in [Section 3.4.2.4](#) and [Section 4.1.6](#). It might just as well be that this first zero is not displayed on your system when entering the **umask** command, and that you only see 3 numbers representing the default file creation mask.

Each UNIX-like system has a system function for creating new files, which is called each time a user uses a program that creates new files, for instance, when downloading a file from the Internet, when saving a new text document and so on. This function creates both new files and new directories. Full read, write and execute permission is granted to everybody when creating a new directory. When creating a new file, this function will grant read and write permissions for everybody, but set execute permissions to none for all user categories. This, before the mask is applied, a directory has permissions *777* or *rw-rw-rwx*, a plain file *666* or *rw-rw-rw-*.

The *umask* value is subtracted from these default permissions after the function has created the new file or directory. Thus, a directory will have permissions of *775* by default, a file *664*, if the mask value is *(0)002*. This is demonstrated in the example below:

```
bert:~> mkdir newdir
bert:~> ls -ld newdir
drwxrwxr-x    2 bert    bert          4096 Feb 28 13:45 newdir/
bert:~> touch newfile
```

```
bert:~> ls -l newfile
-rw-rw-r-- 1 bert bert 0 Feb 28 13:52 newfile
```

The *root* user usually has stricter default file creation permissions:

```
[root@estoban root]# umask
022
```

These defaults are set system-wide in the shell resource configuration files, for instance `/etc/bashrc` or `/etc/profile`. You can change them in your own shell configuration file, see [Chapter 7](#) on customizing your shell environment.

3.4.2.3. Changing user and group ownership

When a file is owned by the wrong user or group, the error can be repaired with the **chown** (change owner) and **chgrp** (change group) commands. Changing file ownership is a frequent task in environments where files need to be shared in a group. Both commands are very flexible, as you can find out by using the `--help` option.

The **chown** command can be applied to change both user and group ownership of a file, while **chgrp** only changes group ownership. Of course the system will check if the user issuing one of these commands has sufficient permissions on the file(s) she wants to change.

In order to only change the user ownership of a file, use this syntax:

chown newuser file

If you use a colon after the user name (see the Info pages), group ownership will be changed as well, to the primary group of the user issuing the command. On a Linux system, each user has his own group, so this form can be used to make files private:

```
jacky:~> id
uid=1304(jacky) gid=(1304) groups=1304(jacky),2034(pproject)

jacky:~> ls -l my_report
-rw-rw-r-- 1 jacky project 29387 Jan 15 09:34 my_report

jacky:~> chown jacky: my_report

jacky:~> chmod o-r my_report

jacky:~> ls -l my_report
-rw-rw---- 1 jacky jacky 29387 Jan 15 09:34 my_report
```

If *jacky* would like to share this file, without having to give everybody permission to write it, he can use the **chgrp** command:

```
jacky:~> ls -l report-20020115.xls
-rw-rw---- 1 jacky jacky 45635 Jan 15 09:35 report-20020115.xls

jacky:~> chgrp project report-20020115.xls

jacky:~> chmod o= report-20020115.xls
```

```
jacky:~> ls -l report-20020115.xls
-rw-rw---- 1 jacky  project 45635 Jan 15 09:35 report-20020115.xls
```

This way, users in the group *project* will be able to work on this file. Users not in this group have no business with it at all.

Both **chown** and **chgrp** can be used to change ownership recursively, using the **-R** option. In that case, all underlying files and subdirectories of a given directory will belong to the given user and/or group.

3.4.2.4. Special modes

For the system admin to not be bothered solving permission problems all the time, special access rights can be given to entire directories, or to separate programs. There are three special modes:

- **Sticky bit mode:** After execution of a job, the command is kept in the system memory. Originally this was a feature used a lot to save memory, but these days memory is inexpensive, so it is not used anymore for its optimizing capabilities on single files. When applied to an entire directory, however, the sticky bit has a different meaning. In that case, a user can only change files in this directory when she is the user owner of the file or when the file has appropriate permissions. This feature is used on directories like */var/tmp*, that have to be accessible for everyone, but where it is not appropriate for users to change or delete each other's data. The sticky bit is indicated by a *t* at the end of the file permission field:

```
mark:~> ls -ld /var/tmp
drwxrwxrwt 19 root  root 8192 Jan 16 10:37 /var/tmp/
```

The sticky bit is set using the command **chmod o+t directory**. The historic origin of the "t" is in UNIX' *save Text access* feature.

- **SUID (set user ID) and SGID (set group ID):** represented by the character *s* in the user or group permission field. When this mode is set on an executable file, it will run with the user and group permissions on the file instead of with those of the user issuing the command, thus giving access to system resources. We will discuss this further in [Chapter 4](#).
- **SGID (set group ID) on a directory:** in this special case every file created in the directory will have the same group owner as the directory itself (while normal behavior would be that new files are owned by the users who create them). This way, users don't need to worry about file ownership when sharing directories:

```
mimi:~> ls -ld /opt/docs
drwxrws--- 4 root  users 4096 Jul 25 2001 docs/

mimi:~> ls -l /opt/docs
-rw-rw---- 1 mimi  users 345672 Aug 30 2001-Council.doc
```

This is the standard way of sharing files in UNIX.



Existing files are left unchanged!

Files that are being moved to a SGID directory but were created elsewhere keep their original user and group owner. This may be confusing.

3.5. Summary

On UNIX, as on Linux, all entities are in some way or another presented to the system as files with the appropriate file properties. Use of (predefined) paths allows the users and the system admin to find, read and

manipulate files.

We've made our first steps toward becoming an expert: we discussed the real and the fake structure of the file system, and we know about the Linux file security model, as well as several other security precautions that are taken on every system by default.

The shell is the most important tool for interaction with the system. We learned several shell commands in this chapter, which are listed in the table below.

Table 3–10. New commands

Command	Meaning
bash	GNU shell program.
cat file(s)	Send content of file(s) to standard output.
cd directory	Enter <i>directory</i> . cd is a bash built-in command.
chgrp newgroup file(s)	Change the group ownership of <i>file(s)</i> to <i>newgroup</i>
chmod mode file(s)	Change access permissions on <i>file(s)</i>
chown newowner[:[newgroup]] file(s)	Change file owner and group ownership.
cp sourcefile targetfile	Copy <i>sourcefile</i> to <i>targetfile</i> .
df file	Reports on used disk space on the partition containing <i>file</i> .
echo string	Display a line of text
export	Part of bash that announces variables and their values to the system.
file filename	Determine file type of <i>filename</i> .
find path expression	Find files in the file system hierarchy
grep PATTERN file	Print lines in <i>file</i> containing the search pattern.
head file	Send the first part of <i>file</i> to standard output
id	Prints real and effective user name and groups.
info command	Read documentation about command .
less file	View <i>file</i> with a powerful viewer.
ln targetfile linkname	Make a link with name <i>linkname</i> to <i>targetfile</i> .
locate searchstring	Print all accessible files matching the search pattern.
ls file(s)	Prints directory content.
man command	Format and display online (system) manual pages for command .
mkdir newdir	Make a new empty directory.
mv oldfile newfile	Rename or move <i>oldfile</i> .
pwd	Print the present or current working directory.
quota	Show disk usage and limits.
rm file	Removes files and directories.
rmdir file	Removes directories.
tail file	Print the last part of <i>file</i> .

umask <i>[value]</i>	Show or change new file creation mode.
wc <i>file</i>	Counts lines, words and characters in <i>file</i> .
which <i>command</i>	Shows the full path to command .

We also stressed the fact that you should READ THE MAN PAGES. This documentation is your first-aid kit and contains the answers to many questions. The above list contains the basic commands that you will use on a daily basis, but they can do much more than the tasks we've discussed here. Reading the documentation will give you the control you need.

3.6. Exercises

Just login with your common user ID.

3.6.1. Partitions

- On which partition is your home directory?
 - How many partitions are on your system?
 - What is the total size of your Linux installation?
-

3.6.2. Paths

- Display your search path.
 - Export a senseless path by entering, for instance, **export PATH=blah** and try listing directory content.
 - What is the path to your home directory? How would another user reach your home directory starting from his own home directory, using a relative path?
 - Go to the `tmp` directory in `/var`.
 - Now go to `share` in `/usr` using only one command. Change to `doc`. What is your present working directory?
-

3.6.3. Tour of the system

- Change to the `/proc` directory.
- What CPU(s) is the system running on?
- How much RAM does it currently use?
- How much swap space do you have?
- What drivers are loaded?
- How many hours has the system been running?
- Change to `/etc/rc.d` and choose the directory appropriate for your run level.
- What services should be running in this level?
- Which services run in graphical mode that don't run in text mode?
- Change to `/etc`
- How long does the system keep the log file in which user logins are monitored?
- Which release are you running?
- Are there any issues or messages of the day?
- How many users are defined on your system? Don't count them, let the computer do it for you!
- How many groups?
- Where is the time zone information kept?

- Are the HOWTOs installed on your system?
 - Change to `/usr/share/doc`.
 - Name three programs that come with the GNU *fileutils* package.
 - Which version of **bash** is installed on this system?
-

3.6.4. Manipulating files

- Create a new directory in your home directory.
 - Can you move this directory to the same level as your home directory?
 - Copy all XPM files from `/usr/share/pixmaps` to the new directory. What does XPM mean?
 - List the files in reverse alphabetical order.
 - Make a directory for files starting with an upper case character and one for files starting with a lower case character. Move all the files to the appropriate directories.
 - Remove the remaining files.
 - Delete the directory and its entire content using a single command.
 - Use **grep** to find out which script starts the Font Server in the graphical run level.
 - Where is the *sendmail* server program?
 - Make a symbolic link in your home directory to `/var/tmp`. Check that it really works.
 - Make another symbolic link in your home directory to this link. Check that it works. Remove the first link and list directory content. What happened to the second link?
-

3.6.5. File permissions

- Can you change file permissions on `/home`?
 - What is your standard file creation mode?
 - Change ownership of `/etc` to your own user and group.
 - Change file permissions of `~/ .bashrc` so that only you and your primary group can read it.
 - Issue the command **locate root**. Do you notice anything special?
 - Make a symbolic link to `/root`. Can it be used?
-

Chapter 4. Processes

Next to files, processes are the most important things on a UNIX/Linux system. In this chapter, we will take a closer look at those processes. We will learn more about:

- ◆ Multi-user processing and multi-tasking
 - ◆ Process types
 - ◆ Controlling processes
 - ◆ Process attributes
 - ◆ The life cycle of a process
 - ◆ System startup and shutdown
 - ◆ SUID and SGID
 - ◆ Managing processes
 - ◆ System speed and response
 - ◆ Scheduling processes
 - ◆ The Vixie cron system
 - ◆ How to get the most out of your system
-

4.1. Processes inside out

4.1.1. Multi-user and multi-tasking

Now that we are more used to our environment and we are able to communicate a little bit with our system, it is time to study the processes we can start in more detail. Not every command starts a single process. Some commands initiate a series of processes, such as **mozilla**; others, like **ls**, are executed as a single command.

Furthermore, Linux is based on UNIX, where it has been common policy to have multiple users running multiple commands, at the same time and on the same system. It is obvious that measures have to be taken to have the CPU manage all these processes, and that functionality has to be provided so users can switch between processes. In some cases, processes will have to continue to run even when the user who started them logs out. And users need a means to reactivate interrupted processes.

We will explain the structure of Linux processes in the next sections.

4.1.2. Process types

4.1.2.1. Interactive processes

Interactive processes are initialized and controlled through a terminal session. In other words, there has to be someone connected to the system to start these processes; they are not started automatically as part of the system functions. These processes can run in the foreground, occupying the terminal that started the program, and you can't start other applications as long as this process is running in the foreground. Alternatively, they can run in the background, so that the terminal in which you started the program can accept new commands while the program is running. Until now, we only used programs running in the foreground – the length of time taken to run them was too short to notice – but viewing a file with the **less** command is a good example of a command occupying the terminal session. In this case, the activated program is waiting for you to do something. The program is still connected to the terminal from where it was started, and the terminal is only

Introduction to Linux

useful for entering commands this program can understand. Other commands will just result in errors or unresponsiveness of the system.

While a process runs in the background, however, the user is not prevented from doing other things in the terminal in which he started the program, while it is running.

The shell offers a feature called *job control* which allows easy handling of multiple processes. This mechanism switches processes between the foreground and the background. Using this system, programs can also be started in the background immediately.

Running a process in the background is only useful for programs that don't need user input (via the shell). Putting a job in the background is typically done when execution of a job is expected to take a long time. In order to free the issuing terminal after entering the command, a trailing ampersand is added. In the example, using graphical mode, we open an extra terminal window from the existing one:

```
billy:~> xterm &
[1] 26558

billy:~> jobs
[1]+  Running                  xterm &
```

The full job control features are explained in detail in the **bash** Info pages, so only the frequently used job control applications are listed here:

Table 4–1. Controlling processes

(part of) command	Meaning
regular_command	Runs this command in the foreground.
command &	Run this command in the background (release the terminal)
jobs	Show commands running in the background.
Ctrl+Z	Interrupt a process running in the foreground (suspend).
Ctrl+C	Stop a process running in the foreground.
%n	Every process running in the background gets a number assigned to it. By using the % expression a job can be referred to using its number, for instance fg %2 .
bg	Reactivate a suspended program in the background.
fg	Puts the job back in the foreground.
kill	End a process (also see Shell Builtin Commands in the Info pages of bash)

More practical examples can be found in the exercises.

Most UNIX systems are likely to be able to run **screen**, which is useful when you actually want another shell to execute commands. Upon calling **screen**, a new session is created with an accompanying shell and/or commands as specified, which you can then put out of the way. In this new session you may do whatever it is you want to do. All programs and operations will run independent of the issuing shell. You can then detach this session, while the programs you started in it continue to run, even when you log out of the originating shell, and pick your *screen* up again any time you like.

This program originates from a time when virtual consoles were not invented yet, and everything needed to be done using one text terminal. To addicts, it still has meaning in Linux, even though we've had virtual consoles for almost ten years.

4.1.2.2. Automatic processes

Automatic or batch processes are not connected to a terminal. Rather, these are tasks that can be queued into a spooler area, where they wait to be executed on a FIFO (first-in, first-out) basis. Such tasks can be executed using one of two criteria:

- At a certain date and time: done using the **at** command, which we will discuss in the second part of this chapter.
- At times when the total system load is low enough to accept extra jobs: done using the **batch** command. By default, tasks are put in a queue where they wait to be executed until the system load is lower than 0.8. In large environments, the system administrator may prefer batch processing when large amounts of data have to be processed or when tasks demanding a lot of system resources have to be executed on an already loaded system. Batch processing is also used for optimizing system performance.

4.1.2.3. Daemons

Daemons are server processes that run continuously. Most of the time, they are initialized at system startup and then wait in the background until their service is required. A typical example is the networking daemon, *xinetd*, which is started in almost every boot procedure. After the system is booted, the network daemon just sits and waits until a client program, such as an FTP client, needs to connect.

4.1.3. Process attributes

A process has a series of characteristics:

- The process ID or PID: a unique identification number used to refer to the process.
- The parent process ID or PPID: the number of the process that started this process.
- Nice number: the degree of friendliness of this process toward other processes (not to be confused with process priority, which is calculated based on this nice number and recent CPU usage of the process).
- Terminal or TTY: terminal to which the process is connected.
- User name of the real and effective user (RUID and EUID): the owner of the process. The real owner is the user issuing the command, the effective user is the one determining access to system resources. RUID and EUID are usually the same, and the process has the same access rights the issuing user would have. An example to clarify this: the browser **mozilla** in `/usr/bin` is owned by user *root*:

```
theo:~> ls -l /usr/bin/mozilla
-rwxr-xr-x 1 root root 4996 Nov 20 18:28 /usr/bin/mozilla*

theo:~> mozilla &
[1] 26595

theo:~> ps -af
UID      PID  PPID  C  STIME TTY          TIME CMD
theo  26601 26599  0  15:04 pts/5    00:00:00 /usr/lib/mozilla/mozilla-bin
theo  26613 26569  0  15:04 pts/5    00:00:00 ps -af
```

When user *theo* starts this program, the process itself and all processes started by the initial process, will be owned by user *theo* and not by the system administrator. When **mozilla** needs access to certain

files, that access will be determined by *theo*'s permissions and not by *root*'s.

- Real and effective group owner (RGID and EGID): The real group owner of a process is the primary group of the user who started the process. The effective group owner is usually the same, except when SGID access mode has been applied to a file.

4.1.4. Displaying process information

The **ps** command is one of the tools for visualizing processes. This command has several options which can be combined to display different process attributes.

With no options specified, **ps** only gives information about the current shell and eventual processes:

```
theo:~> ps
  PID TTY          TIME CMD
 4245 pts/7        00:00:00 bash
 5314 pts/7        00:00:00 ps
```

Since this does not give enough information – generally, at least a hundred processes are running on your system – we will usually select particular processes out of the list of all processes, using the **grep** command in a *pipe*, see [Section 5.1.1.1](#), as in this line, which will select and display all processes owned by a particular user:

ps -ef | grep username

This example shows all processes with a process name of **bash**, the most common login shell on Linux systems:

```
theo:> ps auxw | grep bash
brenda  31970  0.0  0.3  6080 1556 tty2    S  Feb23   0:00  -bash
root    32043  0.0  0.3  6112 1600 tty4    S  Feb23   0:00  -bash
theo    32581  0.0  0.3  6384 1864 pts/1   S  Feb23   0:00  bash
theo    32616  0.0  0.3  6396 1896 pts/2   S  Feb23   0:00  bash
theo    32629  0.0  0.3  6380 1856 pts/3   S  Feb23   0:00  bash
theo    2214   0.0  0.3  6412 1944 pts/5   S  16:18   0:02  bash
theo    4245   0.0  0.3  6392 1888 pts/7   S  17:26   0:00  bash
theo    5427   0.0  0.1  3720  548 pts/7   S  19:22   0:00  grep bash
```

In these cases, the **grep** command finding lines containing the string *bash* is often displayed as well on systems that have a lot of idletime. If you don't want this to happen, use the **pgrep** command.

Bash shells are a special case: this process list also shows which ones are login shells (where you have to give your username and password, such as when you log in in textmode or do a remote login, as opposed to non–login shells, started up for instance by clicking a terminal window icon). Such login shells are preceded with a dash (–).

More info can be found the usual way: **ps --help** or **man ps**. GNU **ps** supports different styles of option formats; the above examples don't contain errors.

Note that **ps** only gives a momentary state of the active processes, it is a one–time recording. The **top** program displays a more precise view by updating the results given by **ps** (with a bunch of options) once every five seconds, generating a new list of the processes causing the heaviest load periodically, meanwhile integrating more information about the swap space in use and the state of the CPU, from the `proc` file system:

Introduction to Linux

```
12:40pm up 9 days, 6:00, 4 users, load average: 0.21, 0.11, 0.03
89 processes: 86 sleeping, 3 running, 0 zombie, 0 stopped
CPU states:  2.5% user,  1.7% system,  0.0% nice, 95.6% idle
Mem:   255120K av, 239412K used, 15708K free, 756K shrd, 22620K buff
Swap: 1050176K av, 76428K used, 973748K free, 82756K cached
```

PID	USER	PRI	NI	SIZE	RSS	SHARE	STAT	%CPU	%MEM	TIME	COMMAND
5005	root	14	0	91572	15M	11580	R	1.9	6.0	7:53	X
19599	jeff	14	0	1024	1024	796	R	1.1	0.4	0:01	top
19100	jeff	9	0	5288	4948	3888	R	0.5	1.9	0:24	gnome-terminal
19328	jeff	9	0	37884	36M	14724	S	0.5	14.8	1:30	mozilla-bin
1	root	8	0	516	472	464	S	0.0	0.1	0:06	init
2	root	9	0	0	0	0	SW	0.0	0.0	0:02	keventd
3	root	9	0	0	0	0	SW	0.0	0.0	0:00	kapm-idled
4	root	19	19	0	0	0	SWN	0.0	0.0	0:00	ksoftirqd_CPU0
5	root	9	0	0	0	0	SW	0.0	0.0	0:33	kswapd
6	root	9	0	0	0	0	SW	0.0	0.0	0:00	kreclaimd
7	root	9	0	0	0	0	SW	0.0	0.0	0:00	bdflush
8	root	9	0	0	0	0	SW	0.0	0.0	0:05	kupdated
9	root	-1	-20	0	0	0	SW<	0.0	0.0	0:00	mdrecoveryd
13	root	9	0	0	0	0	SW	0.0	0.0	0:01	kjournald
89	root	9	0	0	0	0	SW	0.0	0.0	0:00	khubd
219	root	9	0	0	0	0	SW	0.0	0.0	0:00	kjournald
220	root	9	0	0	0	0	SW	0.0	0.0	0:00	kjournald

The first line of **top** contains the same information displayed by the **uptime** command:

```
jeff:~> uptime
3:30pm, up 12 days, 23:29, 6 users, load average: 0.01, 0.02, 0.00
```

The data for these programs is stored among others in `/var/run/utmp` (information about currently connected users) and in the virtual file system `/proc`, for example `/proc/loadavg` (average load information). There are all sorts of graphical applications to view this data, such as the *Gnome System Monitor* and *lavaps*. Open Source initiatives like Big Brother centralize this information along with other server data and logs from multiple servers on one web server, allowing monitoring of the entire IT infrastructure from one workstation.

The relations between processes can be visualized using the **pstree** command:

```
sophie:~> pstree
init--amd
  |-apmd
  |-2*[artsd]
  |-atd
  |-crond
  |-deskguide_apple
  |-eth0
  |-gdm---gdm--X
  |   `--gnome-session--Gnome
  |       |
  |       |   |--ssh-agent
  |       |   `--true
  |-geyes_applet
  |-gkb_applet
  |-gnome-name-serv
  |-gnome-smproxy
  |-gnome-terminal--bash---vim
  |   |
  |   |   |--bash
  |   |   |--bash---pstree
  |   |   `--bash---ssh
```



```

|                                     |-bash---mozilla-bin---mozilla-bin---3*[mozilla-bin]
|                                     `~gnome-pty-helper
|-gpm
|-gweather
|-kapm-idled
|-3*[kdeinit]
|-keventd
|-khubd
|-5*[kjournald]
|-klogd
|-lockd---rpciod
|-lpd
|-mdrecoveryd
|-6*[mingetty]
|-8*[nfsd]
|-nscd---nscd---5*[nscd]
|-ntpd
|-3*[oafd]
|-panel
|-portmap
|-rhnsd
|-rpc.mountd
|-rpc.rquotad
|-rpc.statd
|-sawfish
|-screenshoter_a
|-sendmail
|-sshd---sshd---bash---su---bash
|-syslogd
|-tasklist_applet
|-vmnet-bridge
|-xfs
`~xinetd-ipv6

```

The `-u` and `-a` options give additional information, and for more, refer to the Info pages.

In the next section, we will see how one process can create another.

4.1.5. Life and death of a process

4.1.5.1. Process creation

A new process is created because an existing process makes an exact copy of itself. This child process has the same environment as its parent, only the process ID number is different. This procedure is called *forking*.

After the forking process, the address space of the child process is overwritten with the new process data. This is done through an *exec* call to the system.

The *fork-and-exec* mechanism thus switches an old command with a new, while the environment in which the new program is executed remains the same, including configuration of input and output devices, environment variables and priority. This mechanism is used to create all UNIX processes, so it also applies to the Linux operating system. Even the first process, **init**, with process ID 1, is forked during the boot procedure in the so-called *bootstrapping* procedure.

This scheme illustrates the *fork-and-exec* mechanism. The process ID changes after the fork procedure:

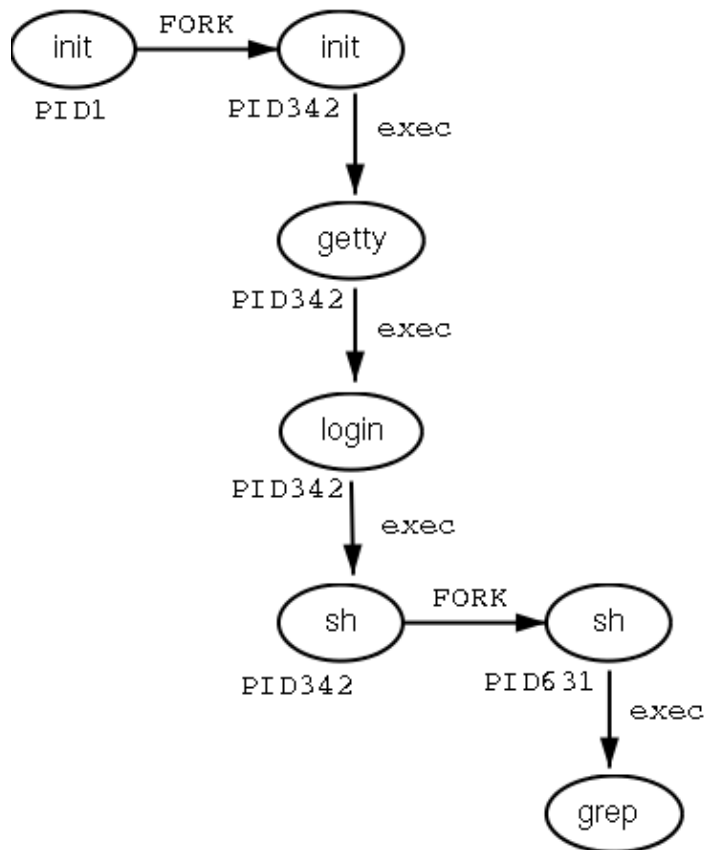
Figure 4–1. Fork-and-exec mechanism

There are a couple of cases in which **init** becomes the parent of a process, while the process was not started by **init**, as we already saw in the **ps** example. Many programs, for instance, *daemonize* their child processes, so they can keep on running when the parent stops or is being stopped. A window manager is a typical example; it starts an **xterm** process that generates a shell that accepts commands. The window manager then denies any further responsibility and passes the child process to **init**. Using this mechanism, it is possible to change window managers without interrupting running applications.

Every now and then things go wrong, even in good families. In an exceptional case, a process might finish while the parent does not wait for the completion of this process. Such an unburied process is called a *zombie* process.

4.1.5.2. Ending processes

When a process ends normally (it is not killed or otherwise unexpectedly interrupted), the program returns its *exit status* to the parent. This exit status is a number returned by the program providing the results of the program's execution. The system of returning information upon executing a job has its origin in the C programming language in which UNIX has been written.

The return codes can then be interpreted by the parent, or in scripts. The values of the return codes are program-specific. This information can usually be found in the man pages of the specified program, for example the **grep** command returns `-1` if no matches are found, upon which a message on the lines of "No files found" can be printed. Another example is the Bash Builtin command **true**, which does nothing except return an exit status of 0, meaning success.

4.1.6. SUID and SGID

As promised in the previous chapter, we will now discuss the special modes SUID and SGID in more detail. These modes exist to provide normal users the ability to execute tasks they would normally not be able to do because of the tight file permission scheme used on UNIX based systems. In the ideal situation special modes are used as sparsely as possible, since they include security risks. Linux developers have generally tried to avoid them as much as possible. The Linux **ps** version, for example, uses the information stored in the `/proc` file system, which is accessible to everyone, thus avoiding exposition of sensitive system data and resources to the general public. Before that, and still on older UNIX systems, the **ps** program needed access to files such as `/dev/mem` and `/dev/kmem`, which had disadvantages because of the permissions and ownerships on these files:

```
rita:~> ls -l /dev/*mem
crw-r----- 1 root    kmem      1,    2 Aug 30 22:30 /dev/kmem
crw-r----- 1 root    kmem      1,    1 Aug 30 22:30 /dev/mem
```

With older versions of **ps**, it was not possible to start the program as a common user, unless special modes were applied to it.

While we generally try to avoid applying any special modes, it is sometimes necessary to use an SUID. An example is the mechanism for changing passwords. Of course users will want to do this themselves instead of having their password set by the system administrator. As we know, user names and passwords are listed in the `/etc/passwd` file, which has these access permissions and owners:

```
bea:~> ls -l /etc/passwd
-rw-r--r-- 1 root    root      1267 Jan 16 14:43 /etc/passwd
```

Still, users need to be able to change their own information in this file. This is achieved by giving the **passwd** program special permissions:

```
mia:~> which passwd
passwd is /usr/bin/passwd

mia:~> ls -l /usr/bin/passwd
-r-s--x--x 1 root    root      13476 Aug  7 06:03 /usr/bin/passwd*
```

When called, the **passwd** command will run using the access permissions of `root`, thus enabling a common user to edit the password file which is owned by the system admin.

SGID modes on a file don't occur nearly as frequently as SUID, because SGID often involves the creation of extra groups. In some cases, however, we have to go through this trouble in order to build an elegant solution (don't worry about this too much – the necessary groups are usually created upon installation). This is the case for the **write** and **wall** programs, which are used to send messages to other users' terminals (tys). The **write** command writes a message to a single user, while **wall** writes to all connected users.

Sending text to another user's terminal or graphical display is normally not allowed. In order to bypass this problem, a group has been created, which owns all terminal devices. When the **write** and **wall** commands are granted SGID permissions, the commands will run using the access rights as applicable to this group, `tty` in the example. Since this group has write access to the destination terminal, also a user having no permissions to use that terminal in any way can send messages to it.

In the example below, user *joe* first finds out on which terminal his correspondent is connected, using the **who** command. Then he sends her a message using the **write** command. Also illustrated are the access rights on the **write** program and on the terminals occupied by the receiving user: it is clear that others than the user owner have no permissions on the device, except for the group owner, which can write to it.

```
joe:~> which write
write is /usr/bin/write

joe:~> ls -l /usr/bin/write
-rwxr-sr-x  1 root  tty      8744 Dec  5 00:55 /usr/bin/write*

joe:~> who
jenny      tty1      Jan 23 11:41
jenny      pts/1     Jan 23 12:21 (:0)
jenny      pts/2     Jan 23 12:22 (:0)
jenny      pts/3     Jan 23 12:22 (:0)
joe        pts/0     Jan 20 10:13 (lo.callhost.org)

joe:~> ls -l /dev/tty1
crw--w----  1 jenny  tty  4,    1 Jan 23 11:41 /dev/tty1

joe:~> write jenny tty1
hey Jenny, shall we have lunch together?
^C
```

User *jenny* gets this on her screen:

```
Message from joe@lo.callhost.org on ptys/1 at 12:36 ...
hey Jenny, shall we have lunch together?
EOF
```

After receiving a message, the terminal can be cleared using the **Ctrl+L** key combination. In order to receive no messages at all (except from the system administrator), use the **mesg** command. To see which connected users accept messages from others use **who -w**. All features are fully explained in the Info pages of each command.



Group names may vary

The group scheme is specific to the distribution. Other distributions may use other names or other solutions.

4.2. Boot process, Init and shutdown

4.2.1. Introduction

One of the most powerful aspects of Linux concerns its open method of starting and stopping the operating system, where it loads specified programs using their particular configurations, permits you to change those configurations to control the boot process, and shuts down in a graceful and organized way.

Beyond the question of controlling the boot or shutdown process, the open nature of Linux makes it much easier to determine the exact source of most problems associated with starting up or shutting down your system. A basic understanding of this process is quite beneficial to everybody who uses a Linux system.

A lot of Linux systems use **lilo**, the LInux LOader for booting operating systems. We will only discuss GRUB, however, which is easier to use and more flexible. Should you need information about **lilo**, refer to the man pages and HOWTOs. Both systems support dual boot installations, we refer to the HOWTOs on this subject for practical examples and background information.

4.2.2. The boot process

When an x86 computer is booted, the processor looks at the end of the system memory for the BIOS (Basic Input/Output System) and runs it. The BIOS program is written into permanent read-only memory and is always available for use. The BIOS provides the lowest level interface to peripheral devices and controls the first step of the boot process.

The BIOS tests the system, looks for and checks peripherals, and then looks for a drive to use to boot the system. Usually it checks the floppy drive (or CD-ROM drive on many newer systems) for bootable media, if present, and then it looks to the hard drive. The order of the drives used for booting is usually controlled by a particular BIOS setting on the system. Once Linux is installed on the hard drive of a system, the BIOS looks for a Master Boot Record (MBR) starting at the first sector on the first hard drive, loads its contents into memory, then passes control to it.

This MBR contains instructions on how to load the GRUB (or LILO) boot-loader, using a pre-selected operating system. The MBR then loads the boot-loader, which takes over the process (if the boot-loader is installed in the MBR). In the default Red Hat Linux configuration, GRUB uses the settings in the MBR to display boot options in a menu. Once GRUB has received the correct instructions for the operating system to start, either from its command line or configuration file, it finds the necessary boot file and hands off control of the machine to that operating system.

4.2.3. GRUB features

This boot method is called *direct loading* because instructions are used to directly load the operating system, with no intermediary code between the boot-loaders and the operating system's main files (such as the kernel). The boot process used by other operating systems may differ slightly from the above, however. For example, Microsoft's DOS and Windows operating systems completely overwrite anything on the MBR when they are installed without incorporating any of the current MBR's configuration. This destroys any other information stored in the MBR by other operating systems, such as Linux. The Microsoft operating systems, as well as various other proprietary operating systems, are loaded using a chain loading boot method. With this method, the MBR points to the first sector of the partition holding the operating system, where it finds the special files necessary to actually boot that operating system.

GRUB supports both boot methods, allowing you to use it with almost any operating system, most popular file systems, and almost any hard disk your BIOS can recognize.

GRUB contains a number of other features; the most important include:

- GRUB provides a true command-based, pre-OS environment on x86 machines to allow maximum flexibility in loading operating systems with certain options or gathering information about the system.
- GRUB supports Logical Block Addressing (LBA) mode, needed to access many IDE and all SCSI hard disks. Before LBA, hard drives could encounter a 1024-cylinder limit, where the BIOS could not find a file after that point.

- GRUB's configuration file is read from the disk every time the system boots, preventing you from having to write over the MBR every time you change the boot options.

A full description of GRUB may be found by issuing the **info grub** command or at [the GRUB site](#). The Linux Documentation Project has a [Multiboot with GRUB Mini-HOWTO](#).

4.2.4. Init

The kernel, once it is loaded, finds **init** in `sbin` and executes it.

When **init** starts, it becomes the parent or grandparent of all of the processes that start up automatically on your Linux system. The first thing **init** does, is reading its initialization file, `/etc/inittab`. This instructs **init** to read an initial configuration script for the environment, which sets the path, starts swapping, checks the file systems, and so on. Basically, this step takes care of everything that your system needs to have done at system initialization: setting the clock, initializing serial ports and so forth.

Then **init** continues to read the `/etc/inittab` file, which describes how the system should be set up in each run level and sets the default *run level*. A run level is a configuration of processes. All UNIX-like systems can be run in different process configurations, such as the single user mode, which is referred to as run level 1 or run level S (or s). In this mode, only the system administrator can connect to the system. It is used to perform maintenance tasks without risks of damaging the system or user data. Naturally, in this configuration we don't need to offer user services, so they will all be disabled. Another run level is the reboot run level, or run level 6, which shuts down all running services according to the appropriate procedures and then restarts the system.

Commonly, run level 3 is configured to be text mode on a Linux machine, and run level 5 initializes the graphical login and environment. More about run levels in the next section, see [Section 4.2.5](#).

After having determined the default run level for your system, **init** starts all of the background processes necessary for the system to run by looking in the appropriate `rc` directory for that run level. **init** runs each of the kill scripts (their file names start with a K) with a stop parameter. It then runs all of the start scripts (their file names start with an S) in the appropriate run level directory so that all services and applications are started correctly. In fact, you can execute these same scripts manually after the system is finished booting with a command like `/etc/rc.d/init.d/httpd stop` or `service httpd stop` logged in as *root*, in this case stopping the web server.

None of the scripts that actually start and stop the services are located in `/etc/rc.d/rc<x>.d`. Rather, all of the files in `/etc/rc.d/rc<x>.d` are symbolic links that point to the actual scripts located in `/etc/rc.d/init.d`. A symbolic link is nothing more than a file that points to another file, and is used in this case because it can be created and deleted without affecting the actual scripts that kill or start the services. The symbolic links to the various scripts are numbered in a particular order so that they start in that order. You can change the order in which the services start up or are killed by changing the name of the symbolic link that refers to the script that actually controls the service. You can use the same number multiple times if you want a particular service started or stopped right before or after another service.

Below a sample of `/etc/rc5.d` content, which lists the services started up in run level 5:

```
[jean@blub /etc/rc5.d] ls
K15httpd@      K45named@      S08ipchains@   S25netfs@      S85gpm@
K16rarpd@      K46radvd@      S08iptables@  S26apmd@       S90cron@
K20nfs@        K61ldap@       S09isdn@      S28autofs@     S90xfs@
```

K20rstatd@	K65identd@	S10network@	S30nscd@	S95anacron@
K20rusersd@	K74ntpd@	S12syslog@	S55sshd@	S95atd@
K20rwall@	K74ypserv@	S13portmap@	S56rawdevices@	S97rhnsd@
K20rwhod@	K74ypxfrd@	S14nfslock@	S56xinetd@	S99local@
K25squid@	K89bcm5820@	S17keytable@	S60lpd@	
K34yppasswdd@	S05kudzu@	S20random@	S80sendmail@	

After **init** has progressed through the run levels to get to the default run level, the `/etc/inittab` script forks a **getty** process for each virtual console (login prompt in text mode). **getty** opens tty lines, sets their modes, prints the login prompt, gets the user's name, and then initiates a login process for that user. This allows users to authenticate themselves to the system and use it. By default, most systems offer 6 virtual consoles, but as you can see from the `inittab` file, this is configurable.

`/etc/inittab` can also tell **init** how it should handle a user pressing **Ctrl+Alt+Delete** at the console. As the system should be properly shut down and restarted rather than immediately power-cycled, **init** is told to execute the command `/sbin/shutdown -t3 -r now`, for instance, when a user hits those keys. In addition, `/etc/inittab` states what **init** should do in case of power failures, if your system has a UPS unit attached to it.

In run level 5, `/etc/inittab` runs a script called `/etc/X11/prefdm`. The `prefdm` script runs the preferred X display manager, based on the contents of the `/etc/sysconfig/desktop` directory. This is typically **gdm** if you run GNOME or **kdm** if you run KDE, but they can be mixed, and there's also the **xdm** that comes with a standard X installation.

The `/etc/sysconfig` directory contains entries for a range of functions and services, these are all read at boot time. This last part, however, might be somewhat different depending on your Linux distribution.

Besides the graphical user environment, a lot of other services may be started as well. But if all goes well, you should be looking at a login prompt or login screen when the boot process has finished.



Other procedures

We explained how SysV **init** works on x86 based machines. Startup procedures may vary on other architectures and distributions. Other systems may use the BSD-style **init**, where startup files are not split up into multiple `/etc/rc.d/rc<LEVEL>.d` directories. It might also be possible that your system uses `/etc/init.d` instead of `/etc/rc.d/init.d`.

4.2.5. Init run levels

The idea behind operating different services at different run levels essentially revolves around the fact that different systems can be used in different ways. Some services cannot be used until the system is in a particular state, or *mode*, such as being ready for more than one user or having networking available.

There are times in which you may want to operate the system in a lower mode. Examples are fixing disk corruption problems in run level 1 so no other users can possibly be on the system, or leaving a server in run level 3 without an X session running. In these cases, running services that depend upon a higher system mode to function does not make sense because they will not work correctly anyway. By already having each service assigned to start when its particular run level is reached, you ensure an orderly start up process, and you can quickly change the mode of the machine without worrying about which services to manually start or stop.

Available run levels are generally described in `/etc/inittab`, which is partially shown below:

```
#
# inittab This file describes how the INIT process should set up
#         the system in a certain run-level.

# Default runlevel. The runlevels are:
# 0 - halt (Do NOT set initdefault to this)
# 1 - Single user mode
# 2 - Multiuser, without NFS
#     (The same as 3, if you do not have networking)
# 3 - Full multiuser mode
# 4 - unused
# 5 - X11
# 6 - reboot (Do NOT set initdefault to this)
#
id:5:initdefault:
<--cut-->
```

Feel free to configure runlevels 2 and 4 as you see fit. Many users configure those runlevels in a way that makes the most sense for them while leaving the standard runlevels 3 and 5 alone. This allows them to quickly move in and out of their custom configuration without disturbing the normal set of features at the standard runlevels.

If your machine gets into a state where it will not boot due to a bad `/etc/inittab` or will not let you log in because you have a corrupted `/etc/passwd` file (or if you have simply forgotten your password), boot into single-user mode.

No graphics?

When you are working in text mode because you didn't get presented a graphical login screen on the console of your machine, you can normally switch to console 7 or up to have a graphical login. If this is not the case, check the current run level using the command **who -r**. If it is set to something else than 5, chances are that the system does not start up in graphical mode by default. Contact your system administrator or read **man init** in that case. Note that switching run levels is done using the **init** command; switching from a text to a graphical console or vice versa does not involve a run level switch.

4.2.5.1. Tools

The **chkconfig** utility in `/sbin` provides a simple command-line tool for maintaining the `/etc/rc.d/init.d` directory hierarchy. It relieves system administrators from having to directly manipulate the numerous symbolic links in the directories under `/etc/rc.d`.

In addition, some systems offer the **ntsysv** tool, which provides a text-based interface; you may find this easier to use than **chkconfig**'s command-line interface. On SuSE Linux, you will find the **yast** and **insserv** tools. For Mandrake easy configuration, you may want to try *DrakConf*, which allows among other features switching between run levels 3 and 5.

Most distributions provide a graphical user interface for configuring processes, check with your system documentation.

All of these utilities must be run as root. The system administrator may also manually create the appropriate links in each run level directory in order to start or stop a service in a certain run level.

4.2.6. Shutdown

UNIX was not made to be shut down, but if you really must, use the **shutdown** command. After completing the shutdown procedure, the `-h` option will halt the system, while `-r` will reboot it.

The **reboot** and **halt** commands are now able to invoke **shutdown** if run when the system is in runlevels 1–5, and thus ensure proper shutdown of the system, but it is a bad habit to get into, as not all UNIX/Linux versions have this feature.

If your computer does not power itself down, you should not turn off the computer until you see a message indicating that the system is halted or finished shutting down, in order to give the system the time to unmount all partitions. Being impatient may cause data loss.

4.3. Managing processes

4.3.1. Work for the system admin

While managing system resources, including processes, is a task for the local system administrator, it doesn't hurt a common user to know something about it, especially where his or her own processes and their optimal execution are concerned.

We will explain a little bit on a theoretical level about system performance, though not as far as hardware optimization and such. Instead, we will study the daily problems a common user is confronted with, and actions such a user can take to optimally use the resources available. As we learn in the next section, this is mainly a matter of thinking before acting.

Figure 4–2. Can't you go faster?



4.3.2. How long does it take?

Bash offers a built-in **time** command that displays how long a command takes to execute. The timing is highly accurate and can be used on any command. In the example below, it takes about a minute and a half to make this book:

```
billy:~/xml/src> time make
Output written on abook.pdf (222 pages, 1619861 bytes).
Transcript written on abook.log.

real    1m41.056s
user    1m31.190s
sys     0m1.880s
```

The GNU **time** command in `/usr/bin` (as opposed to the shell built-in version) displays more information that can be formatted in different ways. It also shows the exit status of the command, and the total elapsed time. The same command as the above using the independent **time** gives this output:

```
billy:~/xml/src> /usr/bin/time make
Output written on abook.pdf (222 pages, 1595027 bytes).
Transcript written on abook.log.

Command exited with non-zero status 2
```

```
88.87user 1.74system 1:36.21elapsed 94%CPU
                                (0avgtext+0avgdata 0maxresident)k
0inputs+0outputs (2192major+30002minor)pagefaults 0swaps
```

Refer again to the Info pages for all the information.

4.3.3. Performance

To a user, performance means quick execution of commands. To a system manager, on the other hand, it means much more: the system admin has to optimize system performance for the whole system, including users, all programs and daemons. System performance can depend on a thousand tiny things which are not accounted for with the **time** command:

- the program executing is badly written or doesn't use the computer appropriately
 - access to disks, controllers, display, all kinds of interfaces, etc.
 - reachability of remote systems (network performance)
 - amount of users on the system, amount of users actually working simultaneously
 - time of day
 - ...
-

4.3.4. Load

In short: the load depends on what is normal for your system. My old P133 running a firewall, SSH server, file server, a route daemon, a sendmail server, a proxy server and some other services doesn't complain with 7 users connected; the load is still 0 on average. Some (multi-CPU) systems I've seen were quite happy with a load of 67. There is only one way to find out – check the load regularly if you want to know what's normal. If you don't, you will only be able to measure system load from the response time of the command line, which is a very rough measurement since this speed is influenced by a hundred other factors.

Keep in mind that different systems will behave different with the same load average. For example, a system with a graphics card supporting hardware acceleration will have no problem rendering 3D images, while the same system with a cheap VGA card will slow down tremendously while rendering. My old P133 will become quite uncomfortable when I start the X server, but on a modern system you hardly notice the difference in the system load.

4.3.5. Can I do anything as a user?

A big environment can slow you down. If you have lots of environment variables set (instead of shell variables), long search paths that are not optimized (errors in setting the path environment variable) and such, the system will need more time to search and read data.

In X, window managers and desktop environments can be real CPU-eaters. A really fancy desktop comes with a price, even when you can download it for free, since most desktops provide add-ons ad infinitum. Modesty is a virtue if you don't buy a new computer every year.

4.3.5.1. Priority

The priority or importance of a job is defined by its *nice* number. A program with a high nice number is friendly to other programs, other users and the system; it is not an important job. The lower the nice number, the more important a job is and the more resources it will take without sharing them.

Making a job nicer by increasing its nice number is only useful for processes that use a lot of CPU time (compilers, math applications and such). Processes that always use a lot of I/O time are automatically rewarded by the system and given a higher priority (a lower nice number), for example keyboard input always gets highest priority on a system.

Defining the priority of a program is done with the **nice** command.

Most systems also provide the BSD **renice** command, which allows you to change the *niceness* of a running command. Again, read the man page for your system-specific information.

Interactive programs

It is NOT a good idea to **nice** or **renice** an interactive program or a job running in the foreground.

Use of these commands is usually a task for the system administrator.

4.3.5.2. CPU resources

On every Linux system, many programs want to use the CPU(s) at the same time, even if you are the only user on the system. Every program needs a certain amount of cycles on the CPU to run. There may be times when there are not enough cycles because the CPU is too busy. The **uptime** command is wildly inaccurate (it only displays averages, you have to know what is normal), but far from being useless. There are some actions you can undertake if you think your CPU is to blame for the unresponsiveness of your system:

- Run heavy programs when the load is low. This may be the case on your system during the night. See next section for scheduling.
- Prevent the system from doing unnecessary work: stop daemons and programs that you don't use, use **locate** instead of a heavy **find**, ...
- Run big jobs with a low priority

If none of these solutions are an option in your particular situation, you may want to upgrade your CPU. On a UNIX machine this is a job for the system admin.

4.3.5.3. Memory resources

When the currently running processes expect more memory than the system has physically available, a Linux system will not crash; it will start paging, or *swapping*, meaning the process uses the memory on disk or in swap space, moving contents of the physical memory (pieces of running programs or entire programs in the case of swapping) to disk, thus reclaiming the physical memory to handle more processes. This slows the system down enormously since access to disk is much slower than access to memory. The **top** command can be used to display memory and swap use. Systems using glibc offer the **memusage** and **memusagestat** commands to visualize memory usage.

If you find that a lot of memory and swap space are being used, you can try:

- Killing, stopping or renicing those programs that use a big chunk of memory
 - Adding more memory (and in some cases more swap space) to the system.
 - Tuning system performance, which is beyond the scope of this document. See the reading list in [Appendix A](#) for more.
-

4.3.5.4. I/O resources

While I/O limitations are a major cause of stress for system admins, the Linux system offers rather poor utilities to measure I/O performance. The **ps**, **vmstat** and **top** tools give some indication about how many programs are waiting for I/O; **netstat** displays network interface statistics, but there are virtually no tools available to measure the I/O response to system load, and the **iostat** command gives a brief overview of general I/O usage. Various graphical front-ends exist to put the output of these commands in a humanly understandable form.

Each device has its own problems, but the bandwidth available to network interfaces and the bandwidth available to disks are the two primary causes of bottlenecks in I/O performance.

Network I/O problems:

- Network overload:

The amount of data transported over the network is larger than the network's capacity, resulting in slow execution of every network related task for all users. They can be solved by cleaning up the network (which mainly involves disabling protocols and services that you don't need) or by reconfiguring the network (for example use of subnets, replacing hubs with switches, upgrading interfaces and equipment).

- Network integrity problems:

Occurs when data is transferred incorrectly. Solving this kind of problem can only be done by isolating the faulty element and replacing it.

Disk I/O problems:

- per-process transfer rate:

Read or write speed for a single process.

- aggregate transfer rate:

Maximum total bandwidth that the system can provide to all programs that run.

This kind of problem is more difficult to detect, and usually takes extra hardware in order to re-divide data streams over buses, controllers and disks, if overloaded hardware is cause of the problem. One solution to solve this is a RAID array configuration optimized for input and output actions. This way, you get to keep the same hardware. An upgrade to faster buses, controllers and disks is usually the other option.

If overload is not the cause, maybe your hardware is gradually failing, or not well connected to the system. Check contacts, connectors and plugs to start with.

4.3.5.5. Users

Users can be divided in several classes, depending on their behavior with resource usage:

- Users who run a (large) number of small jobs: you, the beginning Linux user, for instance.
- Users who run relatively few but large jobs: users running simulations, calculations, emulators or other programs that eat a lot of memory, and usually these users have accompanying large data files.
- Users who run few jobs but use a lot of CPU time (developers and the like).

You can see that system requirements may vary for each class of users, and that it can be hard to satisfy everyone. If you are on a multi-user system, it is useful (and fun) to find out habits of other users and the system, in order to get the most out of it for your specific purposes.

4.3.5.6. Graphical tools

For the graphical environment, there are a whole bunch of monitoring tools available. Below is a screen shot of the Gnome System Monitor, which has features for displaying and searching process information, and monitoring system resources:

Figure 4–3. Gnome System Monitor

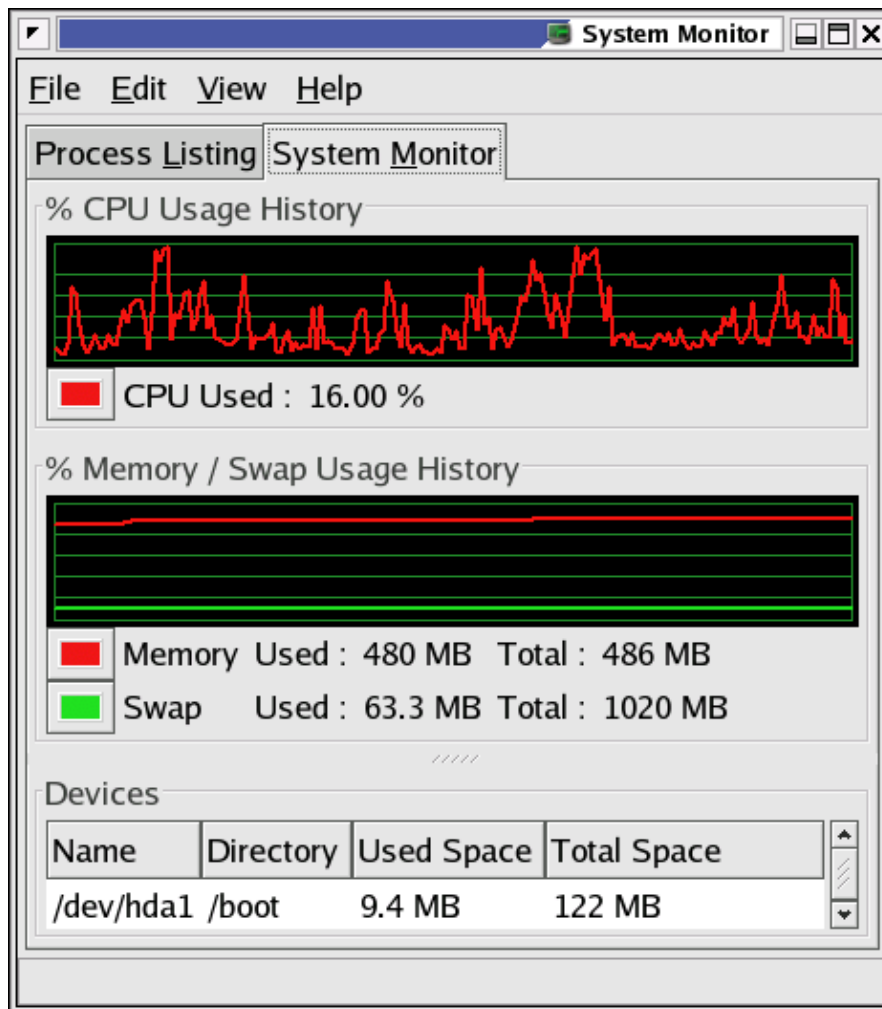

There are also a couple of handy icons you can install in the task bar, such as a disk, memory and load monitor. **xload** is another small X application for monitoring system load. Find your favorite!

4.4. Scheduling processes

4.4.1. Use that idle time!

A Linux system can have a lot to suffer from, but it usually suffers only during office hours. Whether in an office environment, a server room or at home, most Linux systems are just idling away during the morning, the evening, the nights and weekends. Using this idle time can be a lot cheaper than buying those machines you'd absolutely need if you want everything done at the same time.

There are three types of delayed execution:

- Waiting a little while and then resuming job execution, using the **sleep** command. Execution time depends on the system time at the moment of submission.
- Running a command at a specified time, using the **at** command. Execution of the job(s) depends on system time, not the time of submission.
- Regularly running a command on a monthly, weekly, daily or hourly basis, using the **cron** facilities.

The following sections discuss each possibility.

4.4.2. The sleep command

The Info page on sleep is probably one of the shortest there is. All sleep does is wait. By default the time to wait is expressed in seconds.

So why does it exist? Some practical examples:

Somebody calls you on the phone, you say "Yes I'll be with you in half an hour" but you're about drowned in work as it is and bound to forget your lunch:

```
(sleep 1800; echo "Lunch time..") &
```

When you can't use the **at** command for some reason, it's five o'clock, you want to go home but there's still work to do and right now somebody is eating system resources:

```
(sleep 10000; myprogram) &
```

Make sure there's an auto-logout on your system, and that you log out or lock your desktop/office when submitting this kind of job, or run it in a **screen** session.

When you run a series of printouts of large files, but you want other users to be able to print in between:

```
lp lotoftext; sleep 900; lp hugefile; sleep 900; lp anotherlargefile
```

Printing files is discussed in [Chapter 8](#).

Programmers often use the sleep command to halt script or program execution for a certain time.

4.4.3. The at command

The **at** command executes commands at a given time, using your default shell unless you tell the command otherwise (see the man page).

The options to **at** are rather user-friendly, which is demonstrated in the examples below:

```
steven@home:~> at tomorrow + 2 days
warning: commands will be executed using (in order) a) $SHELL
          b) login shell c) /bin/sh
at> cat reports | mail myboss@mycompany
at> <EOT>
job 1 at 2001-06-16 12:36
```

Typing **Ctrl+D** quits the **at** utility and generates the "EOT" message.

User *steven* does a strange thing here combining two commands; we will study this sort of practice in [Chapter 5, Redirecting Input and Output](#).

```
steven@home:~> at 0237
warning: commands will be executed using (in order) a) $SHELL
          b) login shell c) /bin/sh
at> cd new-programs
at> ./configure; make
at> <EOT>
job 2 at 2001-06-14 02:00
```

The **-m** option sends mail to the user when the job is done, or explains when a job can't be done. The command **atq** lists jobs; perform this command before submitting jobs in order prevent them from starting at the same time as others. With the **atrm** command you can remove scheduled jobs if you change your mind.

It is a good idea to pick strange execution times, because system jobs are often run at "round" hours, as you can see in [Section 4.4.4](#) the next section. For example, jobs are often run at exactly 1 o'clock in the morning (e.g. system indexing to update a standard locate database), so entering a time of 0100 may easily slow your system down rather than fire it up. To prevent jobs from running all at the same time, you may also use the **batch** command, which queues processes and feeds the work in the queue to the system in an evenly balanced way, preventing excessive bursts of system resource usage. See the Info pages for more information.

4.4.4. Cron and crontab

The cron system is managed by the cron daemon. It gets information about which programs and when they should run from the system's and users' crontab entries. Only the root user has access to the system crontabs, while each user should only have access to his own crontabs. On some systems (some) users may not have access to the cron facility.

At system startup the cron daemon searches `/var/spool/cron/` for crontab entries which are named after accounts in `/etc/passwd`, it searches `/etc/cron.d/` and it searches `/etc/crontab`, then uses this information every minute to check if there is something to be done. It executes commands as the user who owns the crontab file and mails any output of commands to the owner.

On systems using Vixie cron, jobs that occur hourly, daily, weekly and monthly are kept in separate directories in `/etc` to keep an overview, as opposed to the standard UNIX cron function, where all tasks are entered into one big file.

Example of a Vixie crontab file:

```
[root@blob /etc]# more crontab
SHELL=/bin/bash
```



```

PATH=/sbin:/bin:/usr/sbin:/usr/bin
MAILTO=root
HOME=/

# run-parts
# commands to execute every hour
01 * * * * root run-parts /etc/cron.hourly
# commands to execute every day
02 4 * * * root run-parts /etc/cron.daily
# commands to execute every week
22 4 * * 0 root run-parts /etc/cron.weekly
commands to execute every month
42 4 1 * * root run-parts /etc/cron.monthly

```

Some variables are set, and after that there's the actual scheduling, one line per job, starting with 5 time and date fields. The first field contains the minutes (from 0 to 59), the second defines the hour of execution (0–23), the third is day of the month (1–31), then the number of the month (1–12), the last is day of the week (0–7, both 0 and 7 are Sunday). An asterisk in these fields represents the total acceptable range for the field. Lists are allowed; to execute a job from Monday to Friday enter 1–5 in the last field, to execute a job on Monday, Wednesday and Friday enter 1,3,5.

Then comes the user who should run the processes which are listed in the last column. The example above is from a Vixie cron configuration where root runs the program **run-parts** on regular intervals, with the appropriate directories as options. In these directories, the actual jobs to be executed at the scheduled time are stored as shell scripts, like this little script that is run daily to update the database used by the **locate** command:

```

billy@ahost cron.daily]$ cat slocate.cron
#!/bin/sh
renice +19 -p $$ >/dev/null 2>&1
/usr/bin/updatedb -f "nfs,smbfs,ncpfs,proc,devpts" -e \
"/tmp,/var/tmp, /usr/tmp,/afs,/net"

```

Users are supposed to edit their crontabs in a safe way using the **crontab -e** command. This will prevent a user from accidentally opening more than one copy of his/her crontab file. The default editor is **vi** (see [Chapter 6](#), but you can use any text editor, such as **gvim** or **gedit** if you feel more comfortable with a GUI editor.

When you quit, the system will tell you that a new crontab is installed.

This crontab entry reminds *billy* to go to his sports club every Thursday night:

```

billy:~> crontab -l
# DO NOT EDIT THIS FILE - edit the master and reinstall.
# (/tmp/crontab.20264 installed on Sun Jul 20 22:35:14 2003)
# (Cron version -- $Id: chap4.xml,v 1.12 2004/01/06 17:10:32 tille Exp $)
38 16 * * 3 mail -s "sports evening" billy

```

After adding a new scheduled task, the system will tell you that a new crontab is installed. You do not need to restart the **crond** daemon for the changes to take effect. In the example, *billy* added a new line pointing to a backup script:

```

billy:~> crontab -e
45 15 * * 3 mail -s "sports evening" billy
4 4 * * 4,7 /home/billy/bin/backup.sh

```

```
<--write and quit-->
crontab: installing new crontab
billy:~>
```

The backup .sh script is executed every Thursday and Sunday. See [Section 7.2.5](#) for an introduction to shell scripting. Keep in mind that output of commands, if any, is mailed to the owner of the crontab file. If no mail service is configured, you might find the output of your commands in your local mailbox, /var/spool/mail/<your_username>, a plain text file.



Who runs my commands?

You don't have to specify the user who should run the commands. They are executed with the user's own permissions by default.

4.5. Summary

Linux is a multi-user, multi-tasking operating system that has a UNIX-like way of handling processes. Execution speed of commands can depend on a thousand tiny things. Among others, we learned a lot of new commands to visualize and handle processes. Here's a list:

Table 4–2. Process handling commands

Command	Meaning
at	Queue jobs for later execution.
atq	Lists the user's pending jobs.
atrm	Deletes jobs, determined by their job number.
batch	Executes commands when system load level permits.
crontab	Maintain crontab files for individual users.
halt	Stop the system.
init runlevel	Process control initialization.
jobs	Lists currently executing jobs.
kill	Terminate a process.
mesg	Control write access to your terminal.
netstat	Display network connections, routing tables, interface statistics, masquerade connections and multicast memberships.
nice	Run a program with modified scheduling priority.
ps	Report process status.
pstree	Display a tree of processes.
reboot	Stop the system.
renice	Alter priority of running processes.
shutdown	Bring the system down.
sleep	Delay for a specified time.
time	Time a command or report resource usage.

top	Display top CPU processes.
uptime	Show how long the system has been running.
vmstat	Report virtual memory statistics.
w	Show who is logged on and what they are doing.
wall	Send a message to everybody's terminals.
who	Show who is logged on.
write	Send a message to another user.

4.6. Exercises

These are some exercises that will help you get the feel for processes running on your system.

4.6.1. General

- Run **top** in one terminal while you do the exercises in another.
- Run the **ps** command.
- Read the man pages to find out how to display all your processes.
- Run the command **find /**. What effect does it have on system load? Stop this command.
- In graphical mode, start the **xlock** program in the foreground. Then let it run in the background. Stop the program using the **kill** command.
- What does **kill -9 -1** do?
- Open two terminals or terminal windows again and use **write** to send a message from one to the other.
- Issue the **dmesg** command. What does it tell?
- How long does it take to execute **ls** in the current directory?
- Based on process entries in `/proc`, owned by your UID, how would you work to find out which processes these actually represent?
- How long has your system been running?
- Which is your current TTY?
- Name 3 processes that couldn't have had **init** as an initial parent.
- Name 3 commands which use SUID mode. Explain why this is so.
- Name the commands that are generally causing the highest load on your system.

4.6.2. Booting, init etc.

- Can you reboot the system as a normal user? Why is that?
- According to your current runlevel, name the steps that are taken during shutdown.
- How do you change the system runlevel? Switch from 3 to 5 and vice versa.
- Which kernel is currently load at startup?
- Suppose you have to start some exotic server at boot time. Up until now, you logged in after booting the system and started this server manually using a script named `deliver_pizza` in your home directory. What do you have to do in order to have the service start up automatically in run level 4, which you defined for this purpose only?

4.6.3. Scheduling

- Use **sleep** to create a reminder that your pasta is ready in ten minutes.
 - Create an **at** job that copies all files in your home directory to `/var/tmp` within half an hour. You may want to create a sub-directory in `/var/tmp`.
 - Make a cronjob that does this task every Monday to Friday during lunch.
 - Check that it works.
 - Make a mistake in the crontab entry, like issuing the nonexistent command **coppy** instead of **cp**. What happens upon execution of the task?
-

Chapter 5. I/O redirection

This chapter describes more about the powerful UNIX mechanism of redirecting input, output and errors. Topics include:

- ◆ Standard input, output and errors
- ◆ Redirection operators
- ◆ How to use output of one command as input for another
- ◆ Input redirection
- ◆ Handling standard error messages
- ◆ Combining redirection of input, output and error streams
- ◆ Output filters

5.1. What are standard input and standard output?

Most Linux commands read input, such as a file or another attribute for the command, and write output. By default, input is being given with the keyboard, and output is displayed on your screen. Your keyboard is your "standard input" (stdin) device, and the screen is the "standard output" (stdout) device.

However, since Linux is a flexible system, these default settings don't necessarily have to be applied. The standard output, for example, on a heavily monitored server in a large environment may be a printer.

5.1.1. The redirection operators

5.1.1.1. Output redirection with > and |

Sometimes you will want to put output of a command in a file, or you may want to issue another command on the output of one command. This is known as redirecting output. Redirection is done using either the ">" (greater-than symbol), or using the "|" (pipe) operator which sends the standard output of one command to another command as standard input.

As we saw before, the **cat** command concatenates files and puts them all together to the standard output. By redirecting this output to a file, this file name will be created – or overwritten if it already exists, so take care.

```
nancy:~> cat test1
some words

nancy:~> cat test2
some other words

nancy:~> cat test1 test2 > test3

nancy:~> cat test3
some words
some other words
```

Redirecting "nothing" to an existing file is equal to emptying the file:

```
nancy:~> ls -l list
-rw-rw-r-- 1 nancy nancy 117 Apr  2 18:09 list
```

```
nancy:~> > list
nancy:~> ls -l list
-rw-rw-r-- 1 nancy nancy 0 Apr 4 12:01 list
```

This process is called *truncating*.

The same redirection to a nonexistent file will create a new empty file with the given name:

```
nancy:~> ls -l newlist
ls: newlist: No such file or directory
nancy:~> > newlist
nancy:~> ls -l newlist
-rw-rw-r-- 1 nancy nancy 0 Apr 4 12:05 newlist
```

[Chapter 7](#) gives some more examples on the use of this sort of redirection.

Some examples using piping of commands:

To find a word within some text, display all lines matching "pattern1", and exclude lines also matching "pattern2" from being displayed:

```
grep pattern1 file | grep -v pattern2
```

To display output of a directory listing one page at a time:

```
ls -la | less
```

To find a file in a directory:

```
ls -l | grep part_of_file_name
```

5.1.1.2. Input redirection

In another case, you may want a file to be the input for a command that normally wouldn't accept a file as an option. This redirecting of input is done using the "<" (less-than symbol) operator.

Below is an example of sending a file to somebody, using input redirection.

```
andy:~> mail mike@somewhere.org < to_do
```

If the user *mike* exists on the system, you don't need to type the full address. If you want to reach somebody on the Internet, enter the fully qualified address as an argument to **mail**.

This reads a bit more difficult than the beginner's **cat file | mail someone**, but it is of course a much more elegant way of using the available tools.

5.1.1.3. Combining redirections

The following example combines input and output redirection. The file `text.txt` is first checked for spelling mistakes, and the output is redirected to an error log file:

```
aspell < text.txt > error.log
```

It might be that you have to use the following syntax to spell a file (check with the man pages):

```
aspell -H list < file.txt | sort -u
```

This also uses input and output redirection.

The following command lists all commands that you can issue to examine another file when using `less`:

```
mike:~> less --help | grep -i examine
:e [file]      Examine a new file.
:n            * Examine the (N-th) next file from the command line.
:p            * Examine the (N-th) previous file from the command line.
:x            * Examine the first (or N-th) file from the command line.
```

The `-i` option is used for case-insensitive searches – remember that UNIX systems are very case-sensitive.

If you want to save output of this command for future reference, redirect the output to a file:

```
mike:~> less --help | grep -i examine > examine-files-in-less
mike:~> cat examine-files-in-less
:e [file]      Examine a new file.
:n            * Examine the (N-th) next file from the command line.
:p            * Examine the (N-th) previous file from the command line.
:x            * Examine the first (or N-th) file from the command line.
```

Output of one command can be piped into another command virtually as many times as you want, just as long as these commands would normally read input from standard input and write output to the standard output. Sometimes they don't, but then there may be special options that instruct these commands to behave according to the standard definitions; so read the documentation (man and info pages) of the commands you use if you should encounter errors.

Don't overwrite!

Be careful not to overwrite existing (important) files when redirecting output. Many shells, including Bash, have a built-in feature to protect you from that risk: **noclobber**. See the Info pages for more information. In Bash, you would want to add the `set -o noclobber` command to your `.bashrc` configuration file in order to prevent accidental overwriting of files.

5.1.1.4. The `>>` operator

Instead of overwriting file data, you can also append text to an existing file using two subsequent greater-than signs:

Example:

```
mike:~> date >> wishlist
mike:~> cat wishlist
more money
less work
Thu Feb 28 20:23:07 CET 2002
```

The **date** command would normally put the last line on the screen; now it is appended to the file `wishlist`.

5.1.2. Advanced redirection features

5.1.2.1. Use of file descriptors

There are three types of I/O, which each have their own identifier, called a file descriptor:

- standard input: 0
- standard output: 1
- standard error: 2

In the following descriptions, if the file descriptor number is omitted, and the first character of the redirection operator is `<`, the redirection refers to the standard input (file descriptor 0). If the first character of the redirection operator is `>`, the redirection refers to the standard output (file descriptor 1).

Some practical examples will make this more clear:

```
ls > dirlist 2>&1
```

will direct both standard output and standard error to the file `dirlist`, while the command

```
ls 2>&1 > dirlist
```

will only direct standard output to `dirlist`. This can be a useful option for programmers.

All this is explained in detail in the Bash Info pages.

5.1.2.2. Examples

5.1.2.2.1. Analyzing errors

If your process generates a lot of errors, this is a way to thoroughly examine them:

```
command 2>&1 | less
```

This is often used when creating new software using the **make**, such as in:

```
andy:~/newsoft> make all 2>&1 | less
--output omitted--
```

5.1.2.2.2. Separating standard output from standard error

Constructs like these are often used by programmers, so that output is displayed in one terminal window, and errors in another. Find out which pseudo terminal you are using issuing the **tty** command first:

```
andy:~/newsoft> make all 2> /dev/pts/7
```

5.1.3. Filters

When a program performs operations on input and writes the result to the standard output, it is called a filter. One of the most common uses of filters is to restructure output. We'll discuss a couple of the most important filters below.

5.1.3.1. More about grep

As we saw in [Section 3.3.3.4](#), **grep** scans the output line per line, searching for matching patterns. All lines containing the pattern will be printed to standard output. This behavior can be reversed using the **-v** option.

Some examples: suppose we want to know which files in a certain directory have been modified in February:

```
jenny:~> ls -la | grep Feb
```

The **grep** command, like most commands, is case sensitive. Use the **-i** option to make no difference between upper and lower case. A lot of GNU extensions are available as well, such as **--colour**, which is helpful to highlight searchterms in long lines, and **--after-context**, which prints the number of lines after the last matching line. You can issue a recursive **grep** that searches all subdirectories of encountered directories using the **-r** option. As usual, options can be combined.

Regular expressions can be used to further detail the exact character matches you want to select out of all the input lines. The best way to start with regular expressions is indeed to read the **grep** documentation. An excellent chapter is included in the **info grep** page. Since it would lead us too far discussing the ins and outs of regular expressions, it is strongly advised to start here if you want to know more about them.

Play around a bit with **grep**, it will be worth the trouble putting some time in this most basic but very powerful filtering command. The exercises at the end of this chapter will help you started, see [Section 5.3](#).

5.1.3.2. Filtering output

The command **sort** arranges lines in alphabetical order by default:

```
thomas:~> cat people-I-like | sort
Auntie Emmy
Boyfriend
Dad
Grandma
Mum
My boss
```

But there are many more things **sort** can do. Looking at the file size, for instance. With this command, directory content is sorted smallest files first, biggest files last:

```
ls -la | sort -nk 5
```



Old sort syntax

You might obtain the same result with `ls -la | sort +4n`, but this is an old form which does not comply with the current standards.

The `sort` command is also used in combination with the `uniq` program (or `sort -u`) to sort output and filter out double entries.

5.2. Summary

In this chapter we learned how commands can be linked to each other, and how input from one command can be used as output for another command.

Input/output redirection is a common task on UNIX and Linux machines. This powerful mechanism allows flexible use of the building blocks UNIX is made of.

5.3. Exercises

These exercises give more examples on how to combine commands. The main goal is to try and use the **Enter** key as little as possible.

All exercises are done using a normal user ID, so as to generate some errors. While you're at it, don't forget to read those man pages!

- Use the `cut` command on the output of a long directory listing in order to display only the file permissions. Then pipe this output to `sort` and `uniq` to filter out any double lines. Then use the `wc` to count the different permission types in this directory.
- Put the output of `date` in a file. Append the output of `ls` to this file. Send this file to your local mailbox (don't specify anything `<@domain>`, just the user name will do). When using Bash, you will see a new mail notice upon success.
- List the devices in `/dev` which are currently used by your UID. Pipe through `less` to view them properly.
- Use the command `bash -x` to start up the HTTP daemon with the script in `/etc/rc.d/init.d`. Send standard error to a file. Do the same but now send standard output to the file. Note the difference.
- How many processes are you currently running?
- How many invisible files are in your home directory?
- Use `locate` to find documentation about the kernel.
- Find out which file contains the following entry:

```
root:x:0:0:root:/root:/bin/bash
```

And this one:

```
system:      root
```

- See what happens upon issuing this command:

```
> time; date >> time; cat < time
```

Chapter 6. Text editors

In this chapter, we will discuss the importance of mastering an editor. We will focus mainly on the Improved **vi** editor.

After finishing this chapter, you will be able to:

- ◆ Open and close files in text mode
 - ◆ Edit files
 - ◆ Search text
 - ◆ Undo errors
 - ◆ Merge files
 - ◆ Recover lost files
 - ◆ Find a program or suite for office use
-

6.1. Text editors

6.1.1. Why should I use an editor?

It is very important to be able to use at least one text mode editor. Knowing how to use an editor on your system is the first step to independence.

We will need to master an editor by the next chapter as we need it to edit files that influence our environment. As an advanced user, you may want to start writing scripts, or books, develop websites or new programs. Mastering an editor will immensely improve your productivity as well as your capabilities.

6.1.2. Which editor should I use?

Our focus is on text editors, which can also be used on systems without a graphical environment and in terminal windows. The additional advantage of mastering a text editor is in using it on remote machines. Since you don't need to transfer the entire graphical environment over the network, working with text editors tremendously improves network speed.

There are, as usual, multiple ways to handle the problem. Let's see what editors are commonly available:

6.1.2.1. Ed

The **ed** editor is line-oriented and used to create, display, modify and otherwise manipulate text files, both interactively and by use in shell scripts.

ed is the original text editor on UNIX machines, and thus widely available. For most purposes, however, it is superseded by full-screen editors such as **emacs** and **vi**, see below.

6.1.2.2. GNU Emacs

Emacs is the extensible, customizable, self-documenting, real-time display editor, known on many UNIX and other systems. The text being edited is visible on the screen and is updated automatically as you type your commands. It is a real-time editor because the display is updated very frequently, usually after each character or pair of characters you type. This minimizes the amount of information you must keep in your head as you edit. Emacs is called advanced because it provides facilities that go beyond simple insertion and deletion: controlling subprocesses; automatic indentation of programs; viewing two or more files at once; editing formatted text; and dealing in terms of characters, words, lines, sentences, paragraphs, and pages, as well as expressions and comments in several different programming languages.

Self-documenting means that at any time you can type a special character, **Ctrl+H**, to find out what your options are. You can also use it to find out what any command does, or to find all the commands that pertain to a topic. *Customizable* means that you can change the definitions of Emacs commands in little ways. For example, if you use a programming language in which comments start with ``<***'` and end with ``**>'`, you can tell the Emacs comment manipulation commands to use those strings. Another sort of customization is rearrangement of the command set. For example, if you prefer the four basic cursor motion commands (up, down, left and right) on keys in a diamond pattern on the keyboard, you can rebind the keys that way.

Extensible means that you can go beyond simple customization and write entirely new commands, programs in the Lisp language that are run by Emacs's own Lisp interpreter. Emacs is an *online* extensible system, which means that it is divided into many functions that call each other, any of which can be redefined in the middle of an editing session. Almost any part of Emacs can be replaced without making a separate copy of all of Emacs. Most of the editing commands of Emacs are written in Lisp already; the few exceptions could have been written in Lisp but are written in C for efficiency. Although only a programmer can write an extension, anybody can use it afterward.

When run under the X Window System, Emacs provides its own menus and convenient bindings to mouse buttons. But Emacs can provide many of the benefits of a window system on a text-only terminal. For instance, you can look at or edit several files at once, move text between files, and edit files while running shell commands.

6.1.2.3. Vi(m)

Vim stands for Vi IMproved. It used to be Vi IMitation, but there are so many improvements that a name change was appropriate. Vim is a text editor which includes almost all the commands from the UNIX program **vi** and a lot of new ones.

Commands in the **vi** editor are entered using only the keyboard, which has the advantage that you can keep your fingers on the keyboard and your eyes on the screen, rather than moving your arm repeatedly to the mouse. For those who want it, mouse support and a GUI version with scrollbars and menus can be activated.

We will refer to **vi** or **vim** throughout this book for editing files, while you are of course free to use the editor of your choice. However, we recommend to at least get the **vi** basics in the fingers, because it is the standard text editor on almost all UNIX systems, while **emacs** can be an optional package. There may be small differences between different computers and terminals, but the main point is that if you can work with **vi**, you can survive on any UNIX system.

6.2. Using the Vim editor

6.2.1. Two modes

The **vi** editor is a very powerful tool and has a very extensive built-in manual, which you can activate using the **:help** command when the program is started (instead of using **man** or **info**, which don't contain nearly as much information). We will only discuss the very basics here to get you started.

What makes **vi** confusing to the beginner is that it can operate in two modes: command mode and insert mode. The editor always starts in command mode. Commands move you through the text, search, replace, mark blocks and perform other editing tasks, and some of them switch the editor to insert mode.

This means that each key has not one, but likely two meanings: it can either represent a command for the editor when in command mode, or a character that you want in a text when in insert mode.



Pronunciation

It's pronounced "vee-eye".

6.2.2. Basic commands

6.2.2.1. Moving through the text

Moving through the text is usually possible with the arrow keys. If not, try:

- **h** to move the cursor to the left
- **l** to move it to the right
- **k** to move up
- **j** to move down

SHIFT-G will put the prompt at the end of the document.

6.2.2.2. Basic operations

- **n dd** will delete *n* lines starting from the current cursor position.
- **n dw** will delete *n* words at the right side of the cursor.
- **x** will delete the character on which the cursor is positioned
- **:n** moves to line *n* of the file.
- **:w** will save (write) the file
- **:q** will exit the editor.
- **:q!** forces the exit when you want to quit a file containing unsaved changes.
- **:wq** will save and exit
- **:w newfile** will save the text to *newfile*.
- **:wq!** overrides read-only permission (if you have the permission to override permissions, for instance when you are using the *root* account).
- **/astring** will search the string in the file and position the cursor on the first match below its position.
- **/** will perform the same search again, moving the cursor to the next match.
- **:1, \$s/word/anotherword/g** will replace *word* with *anotherword* throughout the file.
- **yy** will copy a block of text.
- **n p** will paste it *n* times.

- **:recover** will recover a file after an unexpected interruption.
-

6.2.2.3. Commands that switch the editor to insert mode

- **a** will append: it moves the cursor one position to the right before switching to insert mode
- **i** will insert
- **o** will insert a blank line under the current cursor position and move the cursor to that line.

Pressing the **Esc** key switches back to command mode. If you're not sure what mode you're in because you use a really old version of **vi** that doesn't display an "INSERT" message, type **Esc** and you'll be sure to return to command mode. It is possible that the system gives a little alert when you are already in command mode when hitting **Esc**, by beeping or giving a visual bell (a flash on the screen). This is normal behavior.

6.2.3. The easy way

Instead of reading the text, which is quite boring, you can use the **vimtutor** to learn you first Vim commands. This is a thirty minute tutorial that teaches the most basic Vim functionality in eight easy exercises. While you can't learn everything about **vim** in just half an hour, the tutor is designed to describe enough of the commands that you will be able to easily use Vim as an all-purpose editor.

In UNIX and MS Windows, if Vim has been properly installed, you can start this program from the shell or command line, entering the **vimtutor** command. This will make a copy of the tutor file, so that you can edit it without the risk of damaging the original. There are a few translated versions of the tutor. To find out if yours is available, use the two-letter language code. For French this would be **vimtutor fr** (if installed on the system).

6.3. Linux in the office

6.3.1. History

Throughout the last decade the office domain has typically been dominated by MS Office, and, let's face it: the MicroSoft Word, Excell and PowerPoint formats are industry standards that you will have to deal with sooner or later.

This monopoly situation of MicroSoft proved to be a big disadvantage for getting new users to Linux, so a group of German developers started the StarOffice project, that was, and is still, aimed at making an MS Office clone. Their company, StarDivision, was acquired by Sun Microsystems by the end of the 1990s, just before the 5.2 release. Sun continues development but restricted access to the sources. Nevertheless, development on the original set of sources continues in the Open Source community, which had to rename the project to OpenOffice. OpenOffice is now available for a variety of platforms, including MS Windows, Linux, MacOS and Solaris. There is a screenshot in [Section 1.3.2](#).

Almost simultaneously, a couple of other quite famous projects took off. Also a very common alternative to using MS Office is KOffice, the office suite that is popular among KDE and/or SuSE users. Like the original, this clone incorporates an MS Word and Excell compatible program, and much more.

Smaller projects deal with particular programs of the MS example suite, such as Abiword and MS Wordview for compatibility with MS Word documents, and Gnumeric for viewing and creating Excell compatible spreadsheets.

6.3.2. Suites and programs

Current distributions usually come with all the necessary tools. Since these provide excellent guidelines and searchable indexes in the Help menus, we won't discuss them in detail. For references, see your system documentation or the web sites of the projects, such as

- <http://www.openoffice.org>
 - <http://www.koffice.org>
 - [Freshmeat](#) and [SourceForge](#) for various other projects.
-

6.3.3. Remarks

6.3.3.1. General use of office documents

Try to limit the use of office documents for the purposes they were meant for: the office.

An example: it drives most Linux users crazy if you send them a mail that says in the body something like: "Hello, I want to tell you something, see attach", and then the attachment proves to be an MS Word compatible document like: "Hello my friend, how is your new job going and will you have time to have lunch with me tomorrow?" Also a bad idea is the attachment of your signature in such a file, for instance. If you want to sign messages or files, use GPG, the PGP-compatible GNU Privacy Guard or SSL (Secure Socket Layer) certificates.

These users are not annoyed because they are unable to read these documents, or because they are worried that these formats typically generate much larger files, but rather because of the implication that they are using MS Windows, and possibly because of the extra work of starting some additional programs.

6.3.3.2. System and user configuration files

In the next chapter, we start configuring our environment, and this might include editing all kinds of files that determine how a program behave.

Don't edit these files with any office component!

The default file format specification would made the program add several lines of code, defining the format of the file and the fonts used. These lines won't be interpreted in the correct way by the programs depending on them, resulting in errors or a crash of the program reading the file. In some cases, you can save the file as plain text, but you'll run into trouble when making this a habit.

6.3.3.3. But I want a graphical text editor!

If you really insist, try **gedit** or **xedit**; these programs only do text files, which is what we will be needing. If you plan on doing anything serious, though, stick to a real text mode editor such as **vim** or **emacs**.

6.4. Summary

In this chapter we learned to use an editor. While it depends on your own individual preference which one you use, it is necessary to at least know how to use one editor.

The **vi** editor is available on every UNIX system.

Most Linux distributions include an office suite and a graphical text editor.

6.5. Exercises

This chapter has only one exercise: start the Vim tutor by entering **vimtutor** in a terminal session, and get started.

You may alternatively start **emacs** and type **Ctrl+H** and then **T** to invoke the self-paced Emacs tutorial.

Practice is the only way!

Chapter 7. Home sweet /home

This chapter is about configuring your environment. Now that we now how to use an editor, we can change all kinds of files to make ourselves feel better at home. After completing this chapter, you will know more about:

- ◆ Organizing your environment
 - ◆ Common shell setup files
 - ◆ Shell configuration
 - ◆ Configuring the prompt
 - ◆ Configuring the graphical environment
 - ◆ Sound and video applications
 - ◆ Display and window managers
 - ◆ How the X client–server system works
 - ◆ Language and font settings
 - ◆ Installing new software
 - ◆ Updating existing packages
-

7.1. General good housekeeping

7.1.1. Introduction

As we mentioned before, it is easy enough to make a mess of the system. We can't put enough stress on the importance of keeping the place tidy. When you learn this from the start, it will become a good habit that will save you time when programming on a Linux or UNIX system or when confronted with system management tasks. Here are some ways of making life easier on yourself:

- Make a `bin` directory for your program files and scripts.
 - Organize non-executable files in appropriate directories, and make as many directories as you like. Examples include separate directories for images, documents, projects, downloaded files, spreadsheets, personal files, and so on.
 - Make directories private with the `chmod 700 dirname` command.
 - Give your files sensible names, such as `Complaint to the prime minister 050302` rather than `letter1`.
-

7.1.2. Make space

On some systems, the **quota** system may force you to clean up from time to time, or the physical limits of your hard disk may force you to make more space without running any monitoring programs. This section discusses a number of ways, besides using the **rm** command, to reclaim disk space.

Run the **quota -v** command to see how much space is left.

7.1.2.1. Emptying files

Sometimes the content of a file doesn't interest you, but you need the file name as a marker (for instance, you just need the timestamp of a file, a reminder that the file was there or should be there some time in the future). Redirecting the output of a null command is how this is done in the Bourne and Bash shells:

```
andy:~> cat wishlist > placeholder

andy:~> ls -la placeholder
-rw-rw-r-- 1 andy andy 200 Jun 12 13:34 placeholder

andy:~> > placeholder

andy:~> ls -la placeholder
-rw-rw-r-- 1 andy andy 0 Jun 12 13:35 placeholder
```

The process of reducing an existing file to a file with the same name that is 0 bytes large is called "truncating."

For creating a new empty file, the same effect is obtained with the **touch** command. On an existing file, **touch** will only update the timestamp. See the Info pages on **touch** for more details.

To "almost" empty a file, use the **tail** command. Suppose user *andy*'s wishlist becomes rather long because he always adds stuff at the end but never deletes the things he actually gets. Now he only wants to keep the last five items:

```
andy:~> tail -5 wishlist > newlist

andy:~> cat newlist > wishlist

andy:~> rm newlist
```

7.1.2.2. More about log files

Some Linux programs insist on writing all sorts of output in a log file. Usually there are options to only log errors, or to log a minimal amount of information, for example setting the debugging level of the program. But even then, you might not care about the log file. Here are some ways to get rid of them or at least set some limits to their size:

- Try removing the log file when the program is not running, if you are sure that you won't need it again. Some programs may even see, when restarted, that there is no log file and will therefore not log.
- If you remove the log file and the program recreates it, read the documentation for this particular program in search for command options that avoid making log files.
- Try making smaller log files by logging only the information that is relevant to you, or by logging only significant information.
- Try replacing the log file with a symbolic link to `/dev/null`; if you're lucky the program won't complain. Don't do this with the log files of programs that run at system boot or programs that run from cron (see [Chapter 4](#)). These programs might replace the symbolic link with a small file that starts growing again.

7.1.2.3. Mail

Regularly clean out your mailbox, make sub-folders and automatic redirects using **procmail** (see the Info pages) or the filters of your favorite mail reading application. If you have a trash folder, clean it out on a regular basis.

To redirect mail, use the `.forward` file in your home directory. The Linux mail service looks for this file whenever it has to deliver local mail. The content of the file defines what the mail system should do with your mail. It can contain a single line holding a fully qualified E-mail address. In that case the system will send all your mail to this address. For instance, when renting space for a website, you might want to forward the mail destined for the webmaster to your own account in order not to waste disk space. The webmaster's `.forward` may look like this:

```
webmaster@www ~/> cat .forward
mike@pandora.be
```

Using mail forwarding is also useful to prevent yourself from having to check several different mailboxes. You can make every address point to a central and easily accessible account.

You can ask your system administrator to define a forward for you in the local mail aliases file, like when an account is being closed but E-mail remains active for a while.

7.1.2.4. Save space with a link

When several users need access to the same file or program, when the original file name is too long or too difficult to remember, use a symbolic link instead of a separate copy for each user or purpose.

Multiple symbolic links may have different names, e.g. a link may be called `monficher` in one user's directory, and `mylink` in another's. Multiple links (different names) to the same file may also occur in the same directory. This is often done in the `/lib` directory: when issuing the command

```
ls -l /lib
```

you will see that this directory is plenty of links pointing to the same files. These are created so that programs searching for one name would not get stuck, so they are pointed to the correct/current name of the libraries they need.

7.1.2.5. Limit file sizes

The shell contains a built-in command to limit file sizes, **ulimit**, which can also be used to display limitations on system resources:

```
cindy:~> ulimit -a
core file size (blocks)      0
data seg size (kbytes)      unlimited
file size (blocks)          unlimited
max locked memory (kbytes)  unlimited
max memory size (kbytes)    unlimited
open files                   1024
pipe size (512 bytes)       8
stack size (kbytes)         8192
cpu time (seconds)          unlimited
```

```
max user processes      512
virtual memory (kbytes) unlimited
```

Cindy is not a developer and doesn't care about core dumps, which contain debugging information on a program. If you do want core dumps, you can set their size using the **ulimit** command. Read the Info pages on **bash** for a detailed explanation.

7.1.2.6. Compressed files

Compressed files are useful because they take less space on your hard disk. Another advantage is that it takes less bandwidth to send a compressed file over your network. A lot of files, such as the man pages, are stored in a compressed format on your system. Yet unpacking these to get a little bit of information and then having to compress them again is rather time-consuming. You don't want to unpack a man page, for instance, read about an option to a command and then compress the man page again. Most people will probably forget to clean up after they found the information they needed.

So we have tools that work on compressed files, by uncompressing them only in memory. The actual compressed file stays on your disk as it is. Most systems support **egrep**, **zgrep**, **zcat**, **zmore** and such to prevent unnecessary decompressing/compressing actions. See your system's binary directory and the Info pages.

See [Chapter 9](#) for more on the actual compressing of files and examples on making archives.

7.2. Your text environment

7.2.1. Environment variables

7.2.1.1. General

We already mentioned a couple of environment variables, such as `PATH` and `HOME`. Until now, we only saw examples in which they serve a certain purpose to the shell. But there are many other Linux utilities that need information about you in order to do a good job.

What other information do programs need apart from paths and home directories?

A lot of programs want to know about the kind of terminal you are using; this information is stored in the `TERM` variable. In text mode, this will be the *linux* terminal emulation, in graphical mode you are likely to use *xterm*. Lots of programs want to know what your favorite editor is, in case they have to start an editor in a subprocess. The shell you are using is stored in the `SHELL` variable, the operating system type in `OS` and so on. A list of all variables currently defined for your session can be viewed entering the **printenv** command.

The environment variables are managed by the shell. As opposed to regular shell variables, environment variables are inherited by any program you start, including another shell. New processes are assigned a copy of these variables, which they can read, modify and pass on in turn to their own child processes.

There is nothing special about variable names, except that the common ones are in upper case characters by convention. You may come up with any name you want, although there are standard variables that are important enough to be the same on every Linux system, such as `PATH` and `HOME`.

7.2.1.2. Exporting variables

An individual variable's content is usually displayed using the **echo** command, as in these examples:

```
debby:~> echo $PATH
/usr/bin:/usr/sbin:/bin:/sbin:/usr/X11R6/bin:/usr/local/bin

debby:~> echo $MANPATH
/usr/man:/usr/share/man/:/usr/local/man:/usr/X11R6/man
```

If you want to change the content of a variable in a way that is useful to other programs, you have to export the new value from your environment into the environment that runs these programs. A common example is exporting the `PATH` variable. You may declare it as follows, in order to be able to play with the flight simulator software that is in `/opt/FlightGear/bin`:

```
debby:~> PATH=$PATH:/opt/FlightGear/bin
```

This instructs the shell to not only search programs in the current path, `$PATH`, but also in the additional directory `/opt/FlightGear/bin`.

However, as long as the new value of the `PATH` variable is not known to the environment, things will still not work:

```
debby:~> runfgfs
bash: runfgfs: command not found
```

Exporting variables is done using the shell built-in command **export**:

```
debby:~> export PATH

debby:~> runfgfs
--flight simulator starts--
```

In Bash, we normally do this in one elegant step:

export VARIABLE=value

The same technique is used for the `MANPATH` variable, that tells the **man** command where to look for compressed man pages. If new software is added to the system in new or unusual directories, the documentation for it will probably also be in an unusual directory. If you want to read the man pages for the new software, extend the `MANPATH` variable:

```
debby:~> export MANPATH=$MANPATH:/opt/FlightGear/man

debby:~> echo $MANPATH
/usr/man:/usr/share/man:/usr/local/man:/usr/X11R6/man:/opt/FlightGear/man
```

You can avoid retyping this command in every window you open by adding it to one of your shell setup files, see [Section 7.2.2](#).

7.2.1.3. Reserved variables

The following table gives an overview of the most common predefined variables:

Table 7–1. Common environment variables

Variable name	Stored information
DISPLAY	used by the X Window system to identify the display server
DOMAIN	domain name
EDITOR	stores your favorite line editor
HISTSIZE	size of the shell history file in number of lines
HOME	path to your home directory
HOSTNAME	local host name
INPUTRC	location of definition file for input devices such as keyboard
LANG	preferred language
LD_LIBRARY_PATH	paths to search for libraries
LOGNAME	login name
MAIL	location of your incoming mail folder
MANPATH	paths to search for man pages
OS	string describing the operating system
OSTYPE	more information about version etc.
PAGER	used by programs like man which need to know what to do in case output is more than one terminal window.
PATH	search paths for commands
PS1	primary prompt
PS2	secondary prompt
PWD	present working directory
SHELL	current shell
TERM	terminal type
UID	user ID
USER(NAME)	user name
VISUAL	your favorite full–screen editor
XENVIRONMENT	location of your personal settings for X behavior
XFILESEARCHPATH	paths to search for graphical libraries

A lot of variables are not only predefined but also preset, using configuration files. We discuss these in the next section.

7.2.2. Shell setup files

When entering the **ls -a1** command to get a long listing of all files, including the ones starting with a dot, in your home directory, you will see one or more files starting with a **.** and ending in **rc**. For the case of **bash**, this is **.bashrc**. This is the counterpart of the system–wide configuration file **/etc/bashrc**.

When logging into an interactive login shell, **login** will do the authentication, set the environment and start your shell. In the case of **bash**, the next step is reading the general profile from `/etc`, if that file exists. **bash** then looks for `~/ .bash_profile`, `~/ .bash_login` and `~/ .profile`, in that order, and reads and executes commands from the first one that exists and is readable. If none exists, `/etc/bashrc` is applied.

When a login shell exits, **bash** reads and executes commands from the file `~/ .bash_logout`, if it exists.

This procedure is explained in detail in the **login** and **bash** man pages.

7.2.3. A typical set of setup files

Let's look at some of these config files. First `/etc/profile` is read, in which important variables such as `PATH`, `USER` and `HOSTNAME` are set:

```
debby:~> cat /etc/profile
# /etc/profile

# System wide environment and startup programs, for login setup
# Functions and aliases go in /etc/bashrc

# Path manipulation
if [ `id -u` = 0 ] && ! echo $PATH | /bin/grep -q "/sbin" ; then
    PATH=/sbin:$PATH
fi

if [ `id -u` = 0 ] && ! echo $PATH | /bin/grep -q "/usr/sbin" ; then
    PATH=/usr/sbin:$PATH
fi

if [ `id -u` = 0 ] && ! echo $PATH | /bin/grep -q "/usr/local/sbin"
then
    PATH=/usr/local/sbin:$PATH
fi

if ! echo $PATH | /bin/grep -q "/usr/X11R6/bin" ; then
    PATH="$PATH:/usr/X11R6/bin"
fi
```

These lines check the path to set: if *root* opens a shell (user ID 0), it is checked that `/sbin`, `/usr/sbin` and `/usr/local/sbin` are in the path. If not, they are added. It is checked for everyone that `/usr/X11R6/bin` is in the path.

```
# No core files by default
ulimit -S -c 0 > /dev/null 2>&1
```

All trash goes to `/dev/null` if the user doesn't change this setting.

```
USER=`id -un`
LOGNAME=$USER
MAIL="/var/spool/mail/$USER"

HOSTNAME=`/bin/hostname`
HISTSIZE=1000
```

Introduction to Linux

Here general variables are assigned their proper values.

```
if [ -z "$INPUTRC" -a ! -f "$HOME/.inputrc" ]; then
    INPUTRC=/etc/inputrc
fi
```

If the variable `INPUTRC` is not set, and there is no `.inputrc` in the user's home directory, then the default input control file is loaded.

```
export PATH USER LOGNAME MAIL HOSTNAME HISTSIZE INPUTRC
```

All variables are exported, so that they are available to other programs requesting information about your environment.

```
for i in /etc/profile.d/*.sh ; do
    if [ -r $i ]; then
        . $i
    fi
done
unset i
```

All readable shell scripts from the `/etc/profile.d` directory are read and executed. These do things like enabling `color-ls`, aliasing `vi` to `vim`, setting locales etc. The temporary variable `i` is unset to prevent it from disturbing shell behavior later on.

Then **bash** looks for a `.bash_profile` in the user's home directory:

```
debby:~> cat .bash_profile
#####
#                                                                    #
# .bash_profile file                                                #
#                                                                    #
# Executed from the bash shell when you log in.                    #
#                                                                    #
#####

source ~/.bashrc
source ~/.bash_login
```

This very straight forward file instructs your shell to first read `~/.bashrc` and then `~/.bash_login`. You will encounter the **source** built-in shell command regularly when working in a shell environment: it is used to apply configuration changes to the current environment.

The `~/.bash_login` file defines default file protection by setting the **umask** value, see [Section 3.4.2.2](#). The `~/.bashrc` file is used to define a bunch of user-specific aliases and functions and personal environment variables. It first reads `/etc/bashrc`, which describes the default prompt (`PS1`) and the default umask value. After that, you can add your own settings. If no `~/.bashrc` exists, `/etc/bashrc` is read by default:

```
debby:~> cat /etc/bashrc
# /etc/bashrc

# System wide functions and aliases
# Environment stuff goes in /etc/profile
```



```

# by default, we want this to get set.
# Even for non-interactive, non-login shells.
if [ `id -gn` = `id -un` -a `id -u` -gt 99 ]; then
    umask 002
else
    umask 022
fi

# are we an interactive shell?
if [ "$PS1" ]; then
    if [ -x /usr/bin/tput ]; then
        if [ "x`tput kbs`" != "x" ]; then
            # We can't do this with "dumb" terminal
            stty erase `tput kbs`
            elif [ -x /usr/bin/wc ]; then
                if [ "`tput kbs|wc -c`" -gt 0 ]; then
                    # We can't do this with "dumb" terminal
                    stty erase `tput kbs`
                fi
            fi
        fi
    fi
    case $TERM in
        xterm*)
            if [ -e /etc/sysconfig/bash-prompt-xterm ]; then
                PROMPT_COMMAND=/etc/sysconfig/bash-prompt-xterm
            else
                PROMPT_COMMAND='echo -ne "\033]0;${USER}@${HOSTNAME%%.*}:\
${PWD}/${HOME/~}\007"'
            fi
            ;;
        *)
            [ -e /etc/sysconfig/bash-prompt-default ] && PROMPT_COMMAND=\
/etc/sysconfig/bash-prompt-default
            ;;
    esac
    [ "$PS1" = "\s-\v\\\$ " ] && PS1="[u@h \W]\\\$ "

    if [ "x$SHLVL" != "x1" ]; then # We're not a login shell
        for i in /etc/profile.d/*.sh; do
            if [ -x $i ]; then
                . $i
            fi
        done
    fi
fi

```

Upon logout, the commands in `~/ .bash_logout` are executed, which can for instance clear the terminal, so that you have a clean window upon logging out of a remote session, or upon leaving the system console:

```

debby:~> cat .bash_logout
# ~/.bash_logout

clear

```

Let's take a closer look at how these scripts work in the next section. Keep **info bash** close at hand.

7.2.4. The Bash prompt

7.2.4.1. Introduction

The Bash prompt can do much more than displaying such simple information as your user name, the name of your machine and some indication about the present working directory. We can add other information such as the current date and time, number of connected users etc.

Before we begin, however, we will save our current prompt in another environment variable:

```
[jerry@nowhere jerry]$ MYPROMPT=$PS1
[jerry@nowhere jerry]$ echo $MYPROMPT
[\u@\h \W]\$
[jerry@nowhere jerry]$
```

When we change the prompt now, for example by issuing the command `PS1="->"`, we can always get our original prompt back with the command `PS1=$MYPROMPT`. You will, of course, also get it back when you reconnect, as long as you just fiddle with the prompt on the command line and avoid putting it in a shell configuration file.

7.2.4.2. Some examples

In order to understand these prompts and the escape sequences used, we refer to the Bash Info or man pages.

- `export PS1="[\t \j] "`

Displays time of day and number of running jobs

- `export PS1="[\d][\u@\h \w] : "`

Displays date, user name, host name and current working directory. Note that `\W` displays only base names of the present working directory.

- `export PS1="{ \! } "`

Displays history number for each command.

- `export PS1="\[\033[1;35m\]\u@\h\[\033[0m\] "`

Displays user@host in pink.

- `export PS1="\[\033[1;35m\]\u\[\033[0m\] \[\033[1;34m\]\w\[\033[0m\] "`

Sets the user name in pink and the present working directory in blue.

- `export PS1="\[\033[1;44m\]$USER is in \w\[\033[0m\] "`

Prompt for people who have difficulties seeing the difference between the prompt and what they type.

- `export PS1="\[\033[4;34m\]\u@\h \w \[\033[0m\]"`

Underlined prompt.

- `export PS1="\[\033[7;34m\]\u@\h \w \[\033[0m\] "`

White characters on a blue background.

- **export PS1="\[\033[3;35m\]\u@\h \w \[\033[0m\]\a"**

Pink prompt in a lighter font that alerts you when your commands have finished.

- **export PS1=...**

Variables are exported so the subsequently executed commands will also know about the environment. The prompt configuration line that you want is best put in your shell configuration file, `~/.bashrc`.

If you want, prompts can execute shell scripts and behave different under different conditions. You can even have the prompt play a tune every time you issue a command, although this way it gets boring pretty soon. More information can be found in the [Bash–Prompt HOWTO](#).

7.2.5. Shell scripts

7.2.5.1. What are scripts?

A shell script is, as we saw in the shell configuration examples, a text file containing shell commands. When such a file is used as the first non–option argument when invoking Bash, and neither the `-c` nor `-s` option is supplied, Bash reads and executes commands from the file, then exits. This mode of operation creates a non–interactive shell. When Bash runs a shell script, it sets the special parameter `0` to the name of the file, rather than the name of the shell, and the positional parameters are set to the remaining arguments, if any are given. If no additional arguments are supplied, the positional parameters are unset.

A shell script may be made executable by using the **chmod** command to turn on the execute bit. When Bash finds such a file while searching the `PATH` for a command, it spawns a sub–shell to execute it. In other words, executing

filename ARGUMENTS

is equivalent to executing

bash filename ARGUMENTS

if `filename` is an executable shell script. This sub–shell reinitializes itself, so that the effect is as if a new shell had been invoked to interpret the script, with the exception that the locations of commands remembered by the parent (see **hash** in the Info pages) are retained by the child.

Most versions of UNIX make this a part of the operating system's command execution mechanism. If the first line of a script begins with the two characters `#!`, the remainder of the line specifies an interpreter for the program. Thus, you can specify **bash**, **awk**, **perl** or some other interpreter or shell and write the rest of the script file in that language.

The arguments to the interpreter consist of a single optional argument following the interpreter name on the first line of the script file, followed by the name of the script file, followed by the rest of the arguments. Bash will perform this action on operating systems that do not handle it themselves.

Bash scripts often begin with `#!/bin/bash` (assuming that Bash has been installed in `/bin`), since this ensures that Bash will be used to interpret the script, even if it is executed under another shell.

7.2.5.2. Some simple examples

A very simple script consisting of only one command, that says hello to the user executing it:

```
[jerry@nowhere ~] cat hello.sh
#!/bin/bash
echo "Hello $USER"
```

The script actually consists of only one command, **echo**, which uses the *value of* (\$) the `USER` environment variable to print a string customized to the user issuing the command.

Another on-liner, used for displaying connected users:

```
#!/bin/bash
who | cut -d " " -f 1 | sort -u
```

Here is a script consisting of some more lines, that I use to convert wav-files to mp3-format using the **lame** command. The script first makes a list of all wav-files in the current directory and puts it in the variable `LIST`. Then it sets the new name for each file, and converts the file format. After that, it cleans up the wav-files which are replaced by their mp3 counterparts:

```
tille:~> cat /usr/local/bin/wav2mp3
#!/bin/bash
# convert *.wav into *.mp3
LIST=$(ls *.wav)
for i in $LIST; do
    ORIG=$i
    DEST=$(ls $i | cut -d "." -f 1).mp3
    lame -h $ORIG $DEST
    echo "done converting $i, removing.."
    rm $i
done
```

The **cut** command is used in this example to separate the actual file name from the file name suffix. Just entering a line like **mv *.wav *.mp3** won't work. An **echo** command was added in order to display some activity. **echo**'s are generally useful when a script won't work: insert one after each doubted step and you will find the error in no time.

The `/etc/rc.d/init.d` directory contains loads of examples. Let's look at this script that controls the fictive ICanSeeYou server:

```
#!/bin/sh
# description: ICanSeeYou allows you to see networked people

# process name: ICanSeeYou
# pidfile: /var/run/ICanSeeYou/ICanSeeYou.pid
# config: /etc/ICanSeeYou.cfg

# Source function library.
. /etc/rc.d/init.d/functions

# See how (with which arguments) we were called.
case "$1" in
    start)
        echo -n "Starting ICanSeeYou: "
        daemon ICanSeeYou
```

```

        echo
        touch /var/lock/subsys/ICanSeeYou
        ;;
stop)
    echo -n "Shutting down ICanSeeYou: "
    killproc ICanSeeYou
    echo
    rm -f /var/lock/subsys/ICanSeeYou
    rm -f /var/run/ICanSeeYou/ICanSeeYou.pid
    ;;
status)
    status ICanSeeYou
    ;;
restart)
    $0 stop
    $0 start
    ;;
*)
    echo "Usage: $0 {start|stop|restart|status}"
    exit 1
esac

exit 0

```

First, with the `.` command (dot) a set of shell functions, used by almost all shell scripts in `/etc/rc.d/init.d`, is loaded. Then a **case** command is issued, which defines 4 different ways the script can execute. An example might be **ICanSeeYou start**. The decision of which case to apply is made by reading the (first) argument to the script, with the expression `$1`.

When no compliant input is given, the default case, marked with an asteriks, is applied, upon which the script gives an error message. The **case** list is ended with the **esac** statement. In the *start* case the server program is started as a daemon, and a process ID and lock are assigned. In the *stop* case, the server process is traced down and stopped, and the lock and the PID are removed. Options, such as the `daemon` option, and functions like `killproc`, are defined in the `/etc/rc.d/init.d/functions` file. This setup is specific to the distribution used in this example. The initscripts on your system might use other functions, defined in other files, or none at all.

Upon success, the script returns an exit code of zero to its parent.

This script is a fine example of using functions, which make the script easier to read and the work done faster. Note that they use **sh** instead of **bash**, to make them useful on a wider range of systems. On a Linux system, calling **bash** as **sh** results in the shell running in POSIX-compliant mode.

The **bash** man pages contain more information about combining commands, `for`- and `while`-loops and regular expressions, as well as examples. A comprehensible Bash course for system administrators and power users, with exercises, from the same author as this Introduction to Linux guide, is at <http://tille.soti.org/training/bash/>. Detailed description of Bash features and applications is in the reference guide [Advanced Bash Scripting](#).

7.3. The graphical environment

7.3.1. Introduction

The average user may not care too much about his login settings, but Linux offers a wide variety of flashing window and desktop managers for use under X, the graphical environment. The use and configuration of window managers and desktops is straightforward and may even resemble the standard MS Windows, MacIntosh or UNIX CDE environment, although many Linux users prefer flashier desktops and fancier window managers. We won't discuss the user specific configuration here. Just experiment and read the documentation using the built-in Help functions these managers provide and you will get along fine.

We will, however, take a closer look at the underlying system.

7.3.2. The X Window System

The X Window System is a network-transparent window system which runs on a wide range of computing and graphics machines. X Window System servers run on computers with bitmap displays. The X server distributes user input to and accepts output requests from several client programs through a variety of different interprocess communication channels. Although the most common case is for the client programs to be running on the same machine as the server, clients can be run transparently from other machines (including machines with different architectures and operating systems) as well. We will learn how to do this in [Chapter 10](#) on networking and remote applications.

X supports overlapping hierarchical sub-windows and text and graphics operations, on both monochrome and color displays. The number of X client programs that use the X server is quite large. Some of the programs provided in the core X Consortium distribution include:

- **xterm**: a terminal emulator
- **twm**: a minimalistic window manager
- **xdm**: a display manager
- **xconsole**: a console redirect program
- **bitmap**: a bitmap editor
- **xauth**, **xhost** and **iceauth**: access control programs
- **xset**, **xmodmap** and many others: user preference setting programs
- **xclock**: a clock
- **xlsfonts** and others: a font displayer, utilities for listing information about fonts, windows and displays
- **xfs**: a font server
- ...

We refer again to the man pages of these commands for detailed information. More explanations on available functions can be found in the *Xlib – C language X Interface* manual that comes with your X distribution, the *X Window System Protocol* specification, and the various manuals and documentation of X toolkits. The `/usr/share/doc` directory contains references to these documents and many others.

Many other utilities, window managers, games, toolkits and gadgets are included as user-contributed software in the X Consortium distribution, or are available using anonymous FTP on the Internet. Good places to start are <http://www.x.org> and <http://www.xfree.org>.

Furthermore, all your graphical applications, such as your browser, your E-mail program, your image viewing programs, sound playing tools and so on, are all clients to your X server. Note that in normal operation, that is in graphical mode, X clients and the X server on Linux run on the same machine.

7.3.2.1. Display names

From the user's perspective, every X server has a *display name* in the form of:

hostname:displaynumber.screennumber

This information is used by the application to determine how it should connect to the X server and which screen it should use by default (on displays with multiple monitors):

- *hostname*: The host name specifies the name of the client machine to which the display is physically connected. If the host name is not given, the most efficient way of communicating to a server on the same machine will be used.
- *displaynumber*: The phrase "display" is usually used to refer to a collection of monitors that share a common key board and pointer (mouse, tablet, etc.). Most workstations tend to only have one keyboard, and therefore, only one display. Larger, multi-user systems, however, frequently have several displays so that more than one person can be doing graphics work at once. To avoid confusion, each display on a machine is assigned a *display number* (beginning at 0) when the X server for that display is started. The display number must always be given in a display name.
- *screen number*: Some displays share a single keyboard and pointer among two or more monitors. Since each monitor has its own set of windows, each screen is assigned a *screen number* (beginning at 0) when the X server for that display is started. If the screen number is not given, screen 0 will be used.

On POSIX systems, the default display name is stored in your DISPLAY environment variable. This variable is set automatically by the **xterm** terminal emulator. However, when you log into another machine on a network, you might need to set DISPLAY by hand to point to your display, see [Section 10.3.3](#).

More information can be found in the X man pages.

7.3.2.2. Window and desktop managers

The layout of windows on the screen is controlled by special programs called *window managers*. Although many window managers will honor geometry specifications as given, others may choose to ignore them (requiring the user to explicitly draw the window's region on the screen with the pointer, for example).

Since window managers are regular (albeit complex) client programs, a variety of different user interfaces can be built. The X Consortium distribution comes with a window manager named **twm**, but most users prefer something more fancy when system resources permit. Sawfish and Enlightenment are popular examples which allow each user to have a desktop according to mood and style.

A desktop manager makes use of one window manager or another for arranging your graphical desktop in a convenient way, with menubars, drop-down menus, informative messages, a clock, a program manager, a file manager and so on. Among the most popular desktop managers are Gnome and KDE, which both run on almost any Linux distribution and many other UNIX systems.

7.3.3. X server configuration

The X distribution that comes with Linux, *XFree86*, uses the configuration file `XF86Config` for its initial setup. This file configures your video card and is searched for in a number of locations, although it is usually in `/etc/X11`. This file is composed of a number of sections which may be present in any order:

- *Files*: File pathnames
- *ServerFlags*: Server options
- *Module*: Dynamic module loading
- *InputDevice*: Input device description
- *Device*: Graphics device description
- *VideoAdapter*: Video adapter description
- *Monitor*: Monitor description
- *Modes*: Video modes (modlines) description
- *Screen*: Screen configuration
- *ServerLayout*: Overall layout
- *DRI*: DRI-specific configuration (3D settings)
- *Vendor*: Vendor-specific configuration

A full description can be found in the Info or man pages about `XF86Config`. As a user, you needn't worry too much about what is in this file, since everything is normally determined at the time the system is installed.

Should you need to change graphical server settings, however, you can run the configuration tools or edit the configuration files that set up the infrastructure to use the XFree86 server. See the man pages for more information; your distribution might have its own tools. Since misconfiguration may result in unreadable garbage in graphical mode, you may want to make a backup copy of the `XF86Config` file before attempting to change it, just to be on the safe side.

7.4. Sound and video

7.4.1. Sound card configuration

Most Linux distributions provide tools that probe your system for sound cards. Most currently available plug-and-play sound cards should be recognized automatically. If you can hear the samples, just click OK and everything will be set up for you.

If your card is not detected automatically, you may be presented with a list of sound cards and/or of sound card properties from which to choose. After that, you will have to provide the correct I/O port, IRQ and DMA settings. Information about these settings can be found in your sound card documentation. If you are on a dual boot system with MS Windows, this information can be found in the Windows Control Panel as well.

7.4.2. If automatic sound card detection fails

If your soundcard is not supported by default, you will need to apply other techniques. These are described in the [Linux Sound HOWTO](#).

7.4.3. Sound and video playing

7.4.3.1. CD playing and copying

The `cdp` package comes with most distributions and provides `cdp` or `cdplay`, a text-based CD player. Desktop managers usually include a graphical tool, such as the `gnome-cd` player in Gnome, that can be started from a menu.

Be sure to understand the difference between an audio CD and a data CD. You do not have to mount an audio CD into the file system in order to listen to it. This is because the data on such a CD are not Linux file system data; they are accessed and sent to the audio output channel directly, using a CD player program. If your CD is a data CD containing `.mp3` files, you will first need to mount it into the file system, and then use one of the programs that we discuss below in order to play the music. How to mount CDs into the file system is explained in [Section 7.6.5](#).

The `cdparanoia` tool from the package with the same name reads audio directly as data from the CD, without analog conversions, and writes data to a file or pipe in different formats, of which `.wav` is probably the most popular. Various tools for conversion to other formats, such as `.mp3`, come with most distributions or are downloadable as separate packages. The GNU project provides several CD playing, ripping and encoding tools, database managers; see the [Free Software Directory, Audio section](#) for detailed information.

CD burning is covered in [Section 9.2.2](#).

7.4.3.2. Playing music files

7.4.3.2.1. mp3 files

The popular `.mp3` format is widely supported on Linux machines. Most distributions include multiple programs that can play these files; `xmms`, which is presented in the screenshot below, is probably the most wide-spread.

Figure 7–1. Xmms mp3 player



Some distributions don't allow you to play MP3's without modifying your configuration, this is due to license restrictions on the MP3 tools. With the `xmms` player, you now need the "`xmms-mp3`" plugin. If error messages indicate that licensing is the trouble, the following procedure describes the path of least resistance:

- Download and install `apt-get`, for instance from <http://www.freshrpms.net>:
 - `rpm -Uvh /var/tmp/xmms-mp3-1.2.7-21.p.fr1`
- Run the following commands to prepare your system for use with the `apt` package manager:

apt-get update

apt-get upgrade

- Install the `xmms-mp3` plugin:

apt-get install xmms-mp3

- (Don't forget to log out of the `root` account because you've finished modifying your system now) – Play your favorite music:

xmms /my/music/dot.mp3

See [Section 7.6](#) for more on the commands for managing packages.

Both Gnome and KDE incorporate other graphical mp3 players, look in your menus.

Start **xmms** from a menu, or from the command line like this:

```
debby:~/mp3> xmms music.mp3
```

Alternatively, enter the command **xmms *.mp3** for playing all `.mp3` files in a directory.

7.4.3.2.2. Other formats

An overview of other common sound playing and manipulating software:

- Ogg Vorbis: Free audio format: see [the GNU audio directory](#) for tools – they might be included in your distribution as well.
- Real audio and video: **realplay** from [RealNetworks](#).
- SoX or Sound eXchange: actually a sound converter, comes with the **play** program. Plays `.wav`, `.ogg` and various other formats, including raw binary formats.
- Playmidi: a MIDI player, see the GNU directory.
- AlsaPlayer: from the Advanced Linux Sound Architecture project, see the [AlsaPlayer web site](#).
- KMediaPlayer: base for the KDE multimedia tools.

Check your system documentation for particular tools!

7.4.3.3. Volume control

aumix and **alsamixer** are two common text tools for adjusting audio controls. The **alsamixer** has a graphical interface when started from the menu or as **gnome-alsamixer** from the command line. *KMix* does the same in KDE.

Regardless of how you choose to listen to music or other sounds, remember that there may be other people who may not be interested in hearing you or your computer. Try to be courteous, especially in office environments. And use a quality head-set.

7.4.3.4. Video playing, streams and television watching

Various players are available:

- **xine**: a free video player
- **ogle**: DVD player
- **mplayer**: Movie Player for Linux
- **gststreamer**: upcoming project developing the GStreamer library and accompanying tools for audio and video recording, editing and playing, to be included in Gnome. See <http://www.gstreamer.net> for more.
- **totem**: plays both audio and video files, audio CDs, VCD and DVD.
- **realplay**: from RealNetworks.
- **helixplay**: a Real alternative, see [HelixDNA](#).

Most likely, you will find one of these in your graphical menus.

For watching TV there is **zapping** or **xawtv**, among many other tools for watching and capturing TV, video and other streams.

7.5. Region specific settings

7.5.1. Keyboard setup

Setting the keyboard layout is done using the **loadkeys** command for text consoles. Use your local X configuration tool or edit the *Keyboard* section in `XF86Config` manually to configure the layout for graphical mode. The `XkbLayout` is the one you want to set:

```
XkbLayout      "us"
```

This is the default. Change it to your local settings by replacing the quoted value with any of the names listed in the subdirectories of `/lib/kbd/keymaps/`, leaving out the `.map.gz` extension. If you can't find the keymaps, try displaying their location on your system issuing the command

locate .map.gz

It is possible to combine layout settings, like in this example:

```
Xkblayout      "us,ru"
```

Make a backup of the `/etc/X11/XF86Config` file before editing it! You will need to use the *root* account to do this.

Log out and reconnect in order to reload X settings.

The Gnome Keyboard Applet enables real-time switching between layouts; no special permissions are needed for using this program. KDE has a similar tool for switching between keyboard layouts.

7.5.2. Fonts

Use the **setfont** tool to load fonts in text mode. Most systems come with a standard `inputrc` file which enables combining of characters, such as the French "é" (meta characters). The system admin should then add the line

```
export INPUTRC="/etc/inputrc"
```

to the `/etc/bashrc` file.

7.5.3. Time zone

Setting time information is usually done at installation time. After that, it can be kept up to date using an *NTP* (Network Time Protocol) client. Most Linux systems run **ntpd** by default:

```
debby:~> ps -ef | grep ntpd
ntp      24678      1  0  2002 ?          00:00:33 ntpd -U ntp
```

See your system manual and the documentation that comes with the NTP package. Most desktop managers include tools to set the system time, providing that you have access to the system administrator's account.

7.5.4. Language

If you'd rather get your messages from the system in Dutch or French, you may want to set the `LANG` and `LANGUAGE` environment variables, thus enabling locale support for the desired language and eventually the fonts related to character conventions in that language.

With most graphical login systems, such as **gdm** or **kdm**, you have the possibility to configure these language settings before logging in.

Note that on most systems, the default tends to be *en_US.UTF-8* these days. This is not a problem, because systems where this is the default, will also come with all the programs supporting this encoding. Thus, **vi** can edit all the files on your system, **cat** won't behave strange and so on.

Trouble starts when you connect to an older system not supporting this font encoding, or when you open a *UTF-8* encoded file on a system supporting only 1-byte character fonts. The **recode** utility might come in handy to convert files from one character set to another. Read the man pages for an overview of features and usage. Another solution might be to temporarily work with another encoding definition, by setting the `LANG` environment variable:

```
debby:~> acroread /var/tmp/51434s.pdf
Warning: charset "UTF-8" not supported, using "ISO8859-1".
Aborted

debby:~> set | grep UTF
LANG=en_US.UTF-8

debby:~> export LANG=en_US

debby:~> acroread /var/tmp/51434s.pdf
<--new window opens-->
```

7.5.5. Specific information for Belgium

The [Belgian HOWTO](#) gives more detailed information on configuring your machine for Flanders, la Wallonie and the Oostkantons, on how to get on the Internet in Belgium and contains a list of Belgian providers of Linux related commercial and free services.

The [Francophones HOWTO](#) discusses the available support for the French language in–depth.

7.5.6. Other countries

The [list of HOWTOs](#) contains references to Belarusian, Chinese, Esperanto, Finnish, Hebrew, Hellenic, Latvian, Polish, Portugese, Serbian, Slovak, Slovenian, Spanish, Thai and Turkish localization instructions.

7.6. Installing new software

7.6.1. General

Most people are surprised to see that they have a running, usable computer after installing Linux; most distributions contain ample support for video and network cards, monitors and other external devices, so there is usually no need to install extra drivers. Also common tools such as office suites, web browsers, E–mail clients and such are included in the main distributions. Even so, an initial installation might not meet your requirements.

If you just can't find what you need, maybe it is not installed on your system. It may also be that you have the required software, but it does not do what it is supposed to do. Remember that Linux moves fast, and software improves on a daily basis. Don't waste your time troubleshooting problems that might already be resolved.

You can update your system or add packages to it at any time you want. Most software comes in packages. Extra software may be found on your installation CDs or on the Internet. The website of your Linux distribution is a good place to start looking for additional software and contains instructions about how to install it on your type of Linux, see [Appendix A](#). Always read the documentation that comes with new software, and any installation guidelines the package might contain. All software comes with a README file, which you are very strongly advised to read.

7.6.2. Package formats

7.6.2.1. RPM packages

RPM, the RedHat Package Manager, is a powerful package manager that you can use to install, update and remove packages. It allows you to search for packages and keeps track of the files that come with each package. A system is built–in so that you can verify the authenticity of packages downloaded from the Internet. Advanced users can build their own packages with RPM.

An RPM package consists of an archive of files and meta–data used to install and erase the archive files. The meta–data includes helper scripts, file attributes, and descriptive information about the package. Packages come in two varieties: binary packages, used to encapsulate software to be installed, and source packages, containing the source code and recipe necessary to produce binary packages.

Introduction to Linux

Many other distributions support RPM packages, among the popular ones Mandrake and SuSE Linux. Apart from the advice for your distribution, you will want to read **man rpm**.

Most packages are simply installed with the upgrade option, `-U`, whether the package is already installed or not. The RPM package contains a complete version of the program, which overwrites existing versions or installs as a new package. The typical usage is as follows:

```
rpm -Uvh /path/to/rpm-package(s)
```

The `-v` option generates more verbose output, and `-h` makes **rpm** print a progress bar:

```
[root@jupiter tmp]# rpm -Uvh totem-0.99.5-1.fr.i386.rpm
Preparing...                               ##### [100%]
 1:totem                                   ##### [100%]
[root@jupiter tmp]#
```

New kernel packages, however, are installed with the install option `-i`, which does not overwrite existing version(s) of the package, least to be able to boot your system with the old kernel if the new one does not work.

You can also use **rpm** to check whether a package is installed on your system:

```
[david@jupiter ~] rpm -qa | grep vim
vim-minimal-6.1-29
vim-X11-6.1-29
vim-enhanced-6.1-29
vim-common-6.1-29
```

Or you can find out which package contains a certain file or executable:

```
[david@jupiter ~] rpm -qf /etc/profile
setup-2.5.25-1

[david@jupiter ~] which cat
cat is /bin/cat

[david@jupiter ~] rpm -qf /bin/cat
coreutils-4.5.3-19
```

Note that you need not have access to administrative privileges in order to use **rpm** to query the RPM database. You only need to be *root* when adding, modifying or deleting packages.

Below is one last example, demonstrating how to uninstall a package using **rpm**:

```
[root@jupiter root]# rpm -e totem
[root@jupiter root]#
```

Note that uninstalling is not that verbose by default, it is normal that you don't see much happening. When in doubt, use **rpm -qa** again to verify that the package has been removed.

RPM can do much more than the couple of basic functions we discussed in this introduction; the [RPM HOWTO](#) contains further references.

7.6.2.2. DEB packages

This package format is the default on Debian GNU/Linux, where **dselect** is the standard tool for managing the packages. It is used to select packages that you want to install or upgrade, but it will also run during the installation of a Debian system and help you to define the access method to use, to list available packages and to configure packages.

The [Debian web site](#) contains all information you need, including a "dselect Documentation for Beginners".

7.6.2.3. Source packages

The largest part of Linux programs is Free/Open Source, so source packages are available for these programs. Source files are needed for compiling your own program version. Sources are provided when you install development packages or can be downloaded from the particular web site for a program, in the raw (`program-version.tar.gz` or similar) or packaged in an RPM or Debian package.

Specific requirements, dependencies and installation instructions are provided in the README file. You will probably need a C compiler, **gcc**. This GNU C compiler is included in most Linux systems and is ported to many other platforms.

7.6.3. Automating package management and updates

7.6.3.1. General remarks

The first thing you do after installing a new system is applying updates; this applies to all operating systems and Linux is not different.

The updates for most Linux systems can usually be found on a nearby site mirroring your distribution. Lists of sites offering this service can be found at your distribution's web site, see [Appendix A](#).

Updates should be applied regularly, daily if possible – but every couple of weeks would be a reasonable start. You really should try to have the most recent versions of all packages, since Linux changes constantly. As we said before, new features, improvements and bug fixes are supplied at a steady rhythm, and sometimes important security problems are addressed. All this not because Linux is a sloppy system, but rather because the Linux user is not easily satisfied. We want our software to be the best, but getting there and staying there demands some flexibility.

The good news is that most Linux distributions provide tools so that you don't have to upgrade tens of packages daily by hand. The following sections give an overview of "package manager managers." There is much more to this subject, even regular updates of source packages is manageable automatically; we only list the most commonly known systems. Always refer to the documentation for your specific distribution for advised procedures.

7.6.3.2. APT

The Advanced Package Tool is a management system for software packages. The command line tool for handling packages is **apt-get**, which comes with an excellent man page describing how to install and update packages and how to upgrade singular packages or your entire distribution. APT has its roots in the Debian GNU/Linux distribution, where it is the default manager for the Debian packages. APT has been ported to work with RPM packages as well. The main advantage of APT is that it is free and flexible to use. It will

allow you to set up systems similar to the distribution specific (and in some cases commercial) ones listed in the next sections.

Generally, when first using **apt-get**, you will need to get an index of the available packages. This is done using the command

apt-get update

After that, you can use **apt-get** to upgrade your system:

apt-get upgrade

Do this often, it's an easy way to keep your system up-to-date and thus safe.

Apart from this general usage, **apt-get** is also very fast for installing individual packages. This is how it works:

```
[david@jupiter ~] su - -c "apt-get install xsnow"
Password:
Reading Package Lists... Done
Building Dependency Tree... Done
The following NEW packages will be installed:
  xsnow
0 packages upgraded, 1 newly installed, 0 removed and 3 not upgraded.
Need to get 33.6kB of archives.
After unpacking 104kB of additional disk space will be used.
Get:1 http://ayo.freshrpms.net redhat/9/i386/os xsnow 1.42-10 [33.6kB]
Fetched 33.6kB in 0s (106kB/s)
Executing RPM (-Uvh)...
Preparing...      ##### [100%]
 1:xsnow          ##### [100%]
```

Note the `-c` option to the `su` command, which indicates to the root shell to only execute this command, and then return to the user's environment. This way, you cannot forget to quit the root account.

If there are any dependencies on other packages, **apt-get** will download and install these supporting packages.

More information can be found in the [APT HOWTO](#).

7.6.3.3. Systems supporting RPM packages

Update Agent, which originally only supported RedHat RPM packages, is now ported to a wider set of software, including non-RedHat repositories. This tool provides a complete system for updating the RPM packages on a RedHat or Fedora Linux system. On the command line, type **up2date** to update your system. On the desktop, by default a small icon is activated, telling you whether or not there are updates available for your system.

Yellowdog's Updater Modified (**yum**) is another tool that recently became more popular. It is an interactive but automated update program for installing, updating or removing RPM packages on a system.

On SuSE Linux, everything is done with *YaST*, Yet another Setup Tool, which supports a wide variety of system administration tasks, among which updating RPM packages. Starting from SuSE Linux 7.1 you can

also upgrade using a web interface and *YOU*, Yast Online Update.

Mandrake Linux provides so-called URPMI tools, a set of wrapper programs that make installing new software easier for the user. These tools combine with RPM Drake and MandrakeUpdate to provide everything needed for smooth install and uninstall of software packages. MandrakeOnline offers an extended range of services and can automatically notify administrators when updates are available for your particular Mandrake system. Also the KDE and Gnome desktop suites have their own (graphical) versions of package managers, such as *gnorpm* and *KPackage*.

Ximian, a Linux desktop software vendor, has developed RedCarpet, a graphical tool that you can use to subscribe to different upgrade "channels". Different channels are available for upgrading a series of Linux distributions and versions, and for upgrading individual Ximian products, such as the Ximian desktop, the E-mail client Evolution, the upgrade tool itself and much more.

Ximian currently supports RedHat, Debian, Mandrake, Solaris, SuSE and YellowDog systems.

7.6.4. Upgrading your kernel

Most Linux installations are fine if you periodically upgrade your distribution. The upgrade procedure will install a new kernel when needed and make all necessary changes to your system. You should only compile or install a new kernel manually if you need kernel features that are not supported by the default kernel included in your Linux distribution.

Whether compiling your own optimized kernel or using a pre-compiled kernel package, install it in co-existence with the old kernel until you are sure that everything works according to plan.

Then create a dual boot system that will allow you to choose which kernel to boot by updating your boot loader configuration file `grub.conf`. This is a simple example:

```
# grub.conf generated by anaconda
#
# Note that you do not have to rerun grub after making config changes.
# NOTICE: You have a /boot partition. This means that
#           all kernel and initrd paths are relative to /boot/, e.g.
#           root (hd0,0)
#           kernel /vmlinuz-version ro root=/dev/hde8
#           initrd /initrd-version.img
#boot=/dev/hde
default=0
timeout=10
splashimage=(hd0,0)/grub/splash.xpm.gz
title Red Hat Linux new (2.4.9-31)
    root (hd0,0)
    kernel /vmlinuz-2.4.9-31 ro root=/dev/hde8
    initrd /initrd-2.4.9-31.img
title old-kernel
    root (hd0,0)
    kernel /vmlinuz-2.4.9-21 ro root=/dev/hde8
    initrd /initrd-2.4.9-21.img
```

After the new kernel has proven to work, you may remove the lines for the old one from the GRUB config file, although it is best to wait a couple of days just to be sure.

7.6.5. Installing extra packages from the installation CDs

7.6.5.1. Mounting a CD

This is basically done in the same way as installing packages manually, except that you have to append the file system of the CD to your machine's file system to make it accessible. On most systems, this will be done automatically upon insertion of a CD in the drive because the **automount** daemon is started up at boot time. If your CD is not made available automatically, issue the **mount** command in a terminal window. Depending on your actual system configuration, a line similar to this one will usually do the trick:

```
mount /dev/cdrom /mnt/cdrom
```

On some systems, only *root* can mount removable media; this depends on the configuration.

For automation purposes, the CD drive usually has an entry in `/etc/fstab`, which lists the file systems and their mount points, that make up your file system tree. This is such a line:

```
[david@jupiter ~] grep cdrom /etc/fstab
/dev/cdrom      /mnt/cdrom      iso9660          noauto,owner,ro 0 0
```

This indicates that the system will understand the command **mount /mnt/cdrom**. The `noauto` means that on this system, CDs are not mounted automatically.

You may even try to right click on the CD icon on your desktop to mount the CD if your file manager doesn't do it for you. You can check whether it worked issuing the **mount** command with no arguments:

```
[david@jupiter ~] mount | grep cdrom
/dev/cdrom on /mnt/cdrom type iso9660 (ro,nosuid,nodev)
```

7.6.5.2. Using the CD

After mounting the CD, you can change directories, usually to the mount point `/mnt/cdrom`, where you can access the content of the CD-ROM. Use **rpm** just like described in the above section to install additional packages.

7.6.5.3. Ejecting the CD

In order to get the CD out of the drive after you've finished using it, the file system on the CD should be unused. Even being in one of the subdirectories of the mount point, `/mnt/cdrom` in our example, will be considered as "using the file system", so you should get out of there. Do this for instance by typing **cd** with no arguments, which will put you back in your home directory. After that, you can either use the command

```
umount /mnt/cdrom
```

or

```
eject cdrom
```

 **Blocked drives**

NEVER force the drive. The trick with the paperclip is a bad idea, because this will eventually expunge the CD, but your system will think the CD is still there because normal procedures were not followed. Chances are likely that you will have to reboot to get the system back in a consistent state.

If you keep getting "device busy" messages, check first that all shell sessions have left the CD file system and that no graphical applications are using it anymore. When in doubt, use the **lsdf** tool to trace down the process(es) still using the CD resource.

7.7. Summary

When everything has its place, that means already half the work is done.

While keeping order is important, it is equally important to feel at home in your environment, whether text or graphical. The text environment is controlled through the shell setup files. The graphical environment is primarily dependent on the X server configuration, on which a number of other applications are built, such as window and desktop managers and graphical applications, each with their own config files. You should read the system and program specific documentation to find out about how to configure them.

Regional settings such as keyboard setup, installing appropriate fonts and language support are best done at installation time.

Software is managed either automatically or manually using a package system.

7.8. Exercises

7.8.1. Shell environment

- Print out your environment settings. Which variable may be used to store the CPU type of your machine?
 - Make a script that can say something on the lines of "hello, world." Give it appropriate permissions so it can be run. Test your script.
 - Create a directory in your home directory and move the script to the new directory. Permanently add this new directory to your search path. Test that the script can be executed without giving a path to its actual location.
 - Create subdirectories in your home directory to store various files, for instance a directory `music` to keep audio files, a directory `documents` for your notes, and so on. And use them!
 - Create a personalized prompt.
 - Display limits on resource usage. Can you change them?
 - Try to read compressed man pages without decompressing them first.
 - Make an alias `ll` which actually executes `ls -la`.
 - Why does the command `tail testfile > testfile` not work?
 - Mount a data CD, such as your Linux installation CD, and have a look around. Don't forget to unmount when you don't need it anymore.
-

7.8.2. Graphical environment

- Try all the mouse buttons in different regions (terminal, background, task bar).
- Explore the menus.

Introduction to Linux

- Customize your terminal window.
 - Use the mouse buttons to copy and paste text from one terminal to another.
 - Find out how to configure your window manager; try different workspaces (virtual screens).
 - Add an applet, such as a load monitor, to the task bar.
 - Apply a different theme.
 - Enable the so-called *sloppy* focus.
 - Switch to a different window manager.
 - Log out and select a different session type, like KDE if you were using Gnome before. Repeat the previous steps.
 - Find an audio CD or a DVD or such, and try to play it.
-

Chapter 8. Printers and printing

In this chapter we will learn more about printers and printing files. After reading this part, you will be able to:

- ◆ Format documents
- ◆ Print files and check on printer status
- ◆ Troubleshoot printing problems
- ◆ Find necessary documentation to install a printer

8.1. Printing files

8.1.1. General

RedHat ships with LPRng, an improved version of the well-known UNIX print system. If the printer has been set up, all you need to do is learn how to use **lpr** to send files to the printer, which basically comes down to

lpr file(s)

Lpr uses a spooling daemon, **lpd** to print the named files when facilities become available. If no names appear, standard input is assumed (such as when the output of a command is piped into **lpr**). The **lpr** command has a lot of options, which can be displayed using the `--help` option. Full information is in the Info pages. You will also find the **lp** command on your Linux system, for compatibility reasons with other (UNIX) programs. You will find that **lp** is in fact a symbolic link to **lpr**:

```
davy:~> ls -l /usr/bin/lp*
lrwxrwxrwx 1 root root          3 Oct 28 14:21 /usr/bin/lp -> lpr
-rwxr-xr-x 1 lp lp      395192 Aug 11  2001 /usr/bin/lpq
-rwxr-xr-x 1 lp lp      408536 Aug 11  2001 /usr/bin/lpr
-rwxr-xr-x 1 lp lp      392984 Aug 11  2001 /usr/bin/lprm
-rwxr-xr-x 1 root root    4651 Oct 19 22:17 /usr/bin/lprsetup.sh
-rwxr-xr-x 1 lp lp      398488 Aug 11  2001 /usr/bin/lpstat
davy:~> ps -ef | grep lpd
lp      1003      1  0 Feb22 ?          00:00:00 lpd Waiting
```

Once the file is accepted in the print queue, an identification number for the print job is assigned:

```
davy:~> lp /etc/profile
request id is davy@blob+253
```

To view (query) the print queue, use the **lpq** command. When entered without arguments, it displays the contents of the default print queue.

```
davy:~> lpq
Printer: lp@blob
Queue: no printable jobs in queue
Status: job 'cfA284blob.somewhere.org' removed at 11:02:47.098
```

If you don't like what you see, use **lprm** to delete jobs. Use **lprm -** to delete all jobs which you submitted. If you only want to cancel one job, use the number of that job as an argument to **lprm**.

In larger environments, **lpc** may be used to control multiple printers. See the Info on each command.

There are many GUI print tools used as a front–end to **lpr**, and most graphical applications have a print function that uses **lpr**. See the built–in Help functions and program specific documentation for more.

8.1.2. Formatting

8.1.2.1. Tools

If we want to get something sensible out of the printer, files should be formatted first. Apart from an abundance of formatting software, Linux comes with the basic UNIX formatting tools and languages.

Most markup languages are more suitable for large or repetitive jobs, where the computer controls the layout of the text, like when executing scripts.

- **groff**: GNU version of the UNIX **roff** command. It is a front–end to the groff document formatting system. Normally it runs the **troff** command and a post–processor appropriate for the selected device. It allows generation of PostScript files.
- *TeX* and the macro package *LaTeX*: one of the most widely used markup languages on UNIX systems. Usually invoked as **tex**, it formats files and outputs a corresponding device–independent representation of the typeset document.

Technical works are *still* frequently written in LaTeX because of its support for mathematic formulas, although efforts are being made at [W3C](#) (the World Wide Web Consortium) to include this feature in other applications.

- **SGML** and **XML**: Free parsers are available for UNIX and Linux. XML is the next generation SGML, it forms the basis for DocBook XML, a document system (this book is written in XML, for instance).

Linux comes with a lot of formatting tools, such as **pdf2ps**, **fax2ps** and **a2ps**.

Apart from these command line tools there are a lot of graphical word processing programs. Several complete office suites are available, many are free. These do the formatting automatically upon submission of a print job. Just to name a few: AbiWord, KWord, StarOffice, OpenOffice, Applix, WordPerfect, etc.

Printing documentation

The man pages contain pre–formatted **troff** data, they have to be formatted as well. Printing is done using the **-t** option:

```
man -t command > man-command.ps
```

Then print the PostScript file. If a default print destination is configured for your system/account, you can just issue the command **man -t command** to send the formatted page to the printer directly.

For printing Info pages, refer to the Info pages on **info** (you will need the source code of the command).

8.1.2.2. Previewing formatted files

Anything you can send to the printer, can normally be sent to the screen as well. Depending on the file format, you can use one of these commands:

- PostScript files: with the **gv** (GhostView) command.
 - TeX dvi files: with **xdvi**.
 - PDF files: **xpdf** or Adobe's viewer, **acroread**, which is also available for free.
-

8.2. The server side

8.2.1. General

Until a couple of years ago, the choice for Linux users was simple: everyone ran the same old LPD, lifted mostly verbatim out of BSD's Net-2 code.

Today there are a number of systems to choose from. Some distributions come with LPRng, the original BSD UNIX Line Printer Daemon (LPD) revisited. LPD is also the name given to the network printing protocol. This network protocol is spoken not only by the LPD daemon itself, but by essentially every networked print-server, networked printer, and every other print spooler out there; LPD is the least common denominator of standards-based network printing.

LPRng is a far better implementation of the basic LPD design than the regular one; if you must use LPD, consider using LPRng instead. There is far less voodoo involved in making it do what you want, and what voodoo there is is well documented.

LPRng is easier to administer for large installations (read: more than one printer, any serial printers, or any peculiar non-lpd network printers) and has a less haphazard code base than does stock lpd. It can even honestly claim to be secure – there are no SUID binaries, and it supports authentication via PGP or Kerberos.

An interesting new project is the Common UNIX Print System, an implementation of the Internet Printing Protocol (IPP), an HTTP-like RFC standard replacement protocol for the venerable (and clunky) LPD protocol. CUPS is distributed under the GNU Public License. CUPS is also the default print system on MacOS X.

More information can be found at [the CUPS homepage](#).

8.2.2. Graphical printer configuration

Most distributions come with a GUI for configuring networked and local (parallel port) printers. They let you choose the printer type from a list and allow easy testing. You don't have to bother about syntax and location of configuration files. Check your system documentation before you attempt installing your printer.

8.2.3. Buying a printer for Linux

The Linux kernel will let you speak with any printer that you can plug into a serial, parallel, or USB port, plus any printer on the network, but this alone is insufficient; you must also be able to generate data that the printer will understand.

Linux supports almost any HP- and/or IBM-compatible printer. Generally, all printers that can be used on Windows NT or UNIX are fit for Linux as well.

Printers that only come with a Win9x driver could be problematic if they have no other support. Check with the hardware compatibility HOWTO when in doubt.

Your best choice would be a printer with native PostScript support in the firmware, since nearly all UNIX or Linux software producing printable output, produces it in PostScript, the publishing industry's printer control language of choice. PostScript printers are usually a bit more expensive, but it is a device-independent, open programming language.

8.3. Print problems

In this section, we will discuss what you can do as a user when something goes wrong. We won't discuss any problems that have to do with the daemon-part of the printing service, as that is a task for system administrators.

8.3.1. Wrong file

If you print the wrong file, the job may be canceled using the command **lprm jobID**, where jobID is in the form *printername-printjobnumber* (get it from information displayed by **lpq**). This will work when other jobs are waiting to be printed in this printer's queue. However, you have to be really quick if you are the only one using this printer, since jobs are usually spooled and send to the printer in only seconds. Once they arrive on the printer, it is too late to remove jobs using Linux tools.

8.3.2. My print hasn't come out

Use the **lpq** command and see if you can spot your job:

```

elly:~> lpq
Printer: lp@blob
Queue: 2 printable jobs
Server: pid 29998 active
Unspooler: pid 29999 active
Status: waiting for subserver to exit at 09:43:20.699
Rank  Owner/ID          Class Job Files          Size Time
1     elly@blob+997      A    997 (STDIN)          129 09:42:54
2     elly@blob+22       A     22 /etc/profile       917 09:43:20

```

Lots of printers have web interfaces these days, which can display status information by typing the printer's IP address in your web browser:

Figure 8–1. Printer Status through web interface



If your job ID is not there and not on the printer, contact your system administrator. If your job ID is listed in the output, check that the printer is currently printing. If so, just wait, your job will get done in due time.

If the printer is not printing, check that it has paper, check the physical connections to both electricity and data network. If that's okay, the printer may need restarting. Ask your system admin for advice.

In the case of a network printer, try printing from another host. If the printer is reachable from your own host (see [Chapter 10](#) for the **ping** utility), you may try to put the formatted file on it, like `file.ps` in case of a PostScript printer, using an FTP client. If that works, your print system is misconfigured. If it doesn't work, maybe the printer doesn't understand the format you are feeding it.

The [GNU/Linux Printing site](#) contains more tips and tricks.

8.4. Summary

The Linux print service comes with a set of printing tools based on the standard UNIX LPD tools. Below is a list of print-related commands.

Table 8–1. Printing related commands

Command	Meaning
lpr	Print file
lpq	Query print queue
lprm	Remove print job
acroread	PDF viewer
groff	Formatting tool
gv	PostScript viewer
printconf	Configure printers
xdvi	DVI viewer
xpdf	PDF viewer
*2ps	Convert file to PostScript

8.5. Exercises

Configuring and testing printers involves being in the possession of one, and having access to the *root* account. If so, you may try:

- Installing the printer using the GUI on your system.
- Printing a test page using the GUI.
- Printing a test page using the **lp** command.
- Print from within an application, for example Mozilla or OpenOffice, by choosing File->Print from the menu.
- Disconnect the printer from the network or the local machine/print-server. What happens when you try to print something?

The following exercises can be done without printer or root access.

- Try to make PostScript files from different source files, (e.g. HTML, PDF, man pages). Test the results with the **gv** viewer.
 - Check that the print daemon is running.
 - Print the files anyway. What happens?
 - Make a PostScript file using Mozilla. Test it with **gv**.
 - Convert it to PDF format. Test with **xpdf**.
 - How would you go about printing a GIF file from the command line?
-

Chapter 9. Fundamental Backup Techniques

Accidents will happen sooner or later. In this chapter, we'll discuss how to get data to a safe place using other hosts, floppy disks, CD-ROMs and tapes. We will also discuss the most popular compressing and archiving commands.

Upon completion of this chapter, you will know how to:

- ◆ Make, query and unpack file archives
- ◆ Handle floppy disks and make a boot disk for your system
- ◆ Write CD-ROMs
- ◆ Make incremental backups
- ◆ Create Java archives
- ◆ Find documentation to use other backup devices and programs

9.1. Introduction

Although Linux is one of the safest operating systems in existence, and even if it is designed to keep on going, data can get lost. Data loss is most often the consequence of user errors, but occasionally a system fault, such as a power failure, is the cause, so it's always a good idea to keep an extra copy of sensitive and/or important data.

9.1.1. Preparing your data

9.1.1.1. Archiving with tar

In most cases, we will first collect all the data to back up in a single archive file, which we will compress later on. The process of archiving involves concatenating all listed files and taking out unnecessary blanks. In Linux, this is commonly done with the **tar** command. **tar** was originally designed to archive data on tapes, but it can also make archives, know as *tarballs*.

tar has many options, the most important ones are cited below:

- **-v**: verbose
- **-t**: test, shows content of a tarball
- **-x**: extract archive
- **-c**: create archive
- **-f archivedevice**: use *archivedevice* as source/destination for the tarball, the device defaults to the first tape device (usually `/dev/st0` or something similar)
- **-j**: filter through **bzip2**, see [Section 9.1.1.2](#)

It is common to leave out the dash-prefix with **tar** options, as you can see from the examples below.



Use GNU tar for compatibility

The archives made with a proprietary **tar** version on one system, may be incompatible with **tar** on another proprietary system. This may cause much headaches, such as if the archive needs to be recovered on a system that doesn't exist anymore. Use the GNU **tar** version on all systems to prevent

Introduction to Linux

your system admin from bursting into tears. Linux always uses GNU tar. When working on other UNIX machines, enter **tar --help** to find out which version you are using. Contact your system admin if you don't see the word GNU somewhere.

In the example below, an archive is created and unpacked.

```
gaby:~> ls images/
me+tux.jpg  nimf.jpg

gaby:~> tar cvf images-in-a-dir.tar images/
images/
images/nimf.jpg
images/me+tux.jpg

gaby:~> cd images

gaby:~/images> tar cvf images-without-a-dir.tar *.jpg
me+tux.jpg
nimf.jpg

gaby:~/images> cd

gaby:~> ls */*.tar
images/images-without-a-dir.tar

gaby:~> ls *.tar
images-in-a-dir.tar

gaby:~> tar xvf images-in-a-dir.tar
images/
images/nimf.jpg
images/me+tux.jpg

gaby:~> tar tvf images/images-without-dir.tar
-rw-r--r-- gaby/gaby 42888 1999-06-30 20:52:25 me+tux.jpg
-rw-r--r-- gaby/gaby 7578 2000-01-26 12:58:46 nimf.jpg

gaby:~> tar xvf images/images-without-a-dir.tar
me+tux.jpg
nimf.jpg

gaby:~> ls *.jpg
me+tux.jpg  nimf.jpg
```

This example also illustrates the difference between a tarred directory and a bunch of tarred files. It is advisable to only compress directories, so files don't get spread all over when unpacking the tarball (which may be on another system, where you may not know which files were already there and which are the ones from the archive).

When a tape drive is connected to your machine and configured by your system administrator, the file names ending in `.tar` are replaced with the tape device name, for example:

```
tar cvf /dev/tape mail/
```

The directory `mail` and all the files it contains are compressed into a file that is written on the tape immediately. A content listing is displayed because we used the verbose option.

9.1.1.2. Incremental backups with tar

The **tar** tool supports the creation of incremental backups, using the **-N** option. With this option, you can specify a date, and **tar** will check modification time of all specified files against this date. If files are changed more recent than date, they will be included in the backup. The example below uses the timestamp on a previous archive as the date value. First, the initial archive is created and the timestamp on the initial backup file is shown. Then a new file is created, upon which we take a new backup, containing only this new file:

```
jimmy:~> tar cvpf /var/tmp/javaproggies.tar java/*.java
java/btw.java
java/error.java
java/hello.java
java/income2.java
java/income.java
java/inputdevice.java
java/input.java
java/master.java
java/method1.java
java/mood.java
java/moodywaitress.java
java/test3.java
java/TestOne.java
java/TestTwo.java
java/Vehicle.java

jimmy:~> ls -l /var/tmp/javaproggies.tar
-rw-rw-r-- 1 jimmy jimmy 10240 Jan 21 11:58 /var/tmp/javaproggies.tar

jimmy:~> touch java/newprog.java

jimmy:~> tar -N /var/tmp/javaproggies.tar \
-cvp /var/tmp/incremental1-javaproggies.tar java/*.java 2> /dev/null
java/newprog.java

jimmy:~> cd /var/tmp/

jimmy:~> tar xvf incremental1-javaproggies.tar
java/newprog.java
```

Standard errors are redirected to `/dev/null`. If you don't do this, **tar** will print a message for each unchanged file, telling you it won't be dumped.

This way of working has the disadvantage that it looks at timestamps on files. Say that you download an archive into the directory containing your backups, and the archive contains files that have been created two years ago. When checking the timestamps of those files against the timestamp on the initial archive, the new files will actually seem old to **tar**, and will not be included in an incremental backup made using the **-N** option.

A better choice would be the **-g** option, which will create a list of files to backup. When making incremental backups, files are checked against this list. This is how it works:

```
jimmy:~> tar cvpf work-20030121.tar -g snapshot-20030121 work/
work/
work/file1
work/file2
work/file3
```

```
jimmy:~> file snapshot-20030121
snapshot-20030121: ASCII text
```

The next day, user *jimmy* works on `file3` a bit more, and creates `file4`. At the end of the day, he makes a new backup:

```
jimmy:~> tar cvpf work-20030122.tar -g snapshot-20030121 work/
work/
work/file3
work/file4
```

These are some very simple examples, but you could also use this kind of command in a cronjob (see [Section 4.4.4](#)), which specifies for instance a snapshot file for the weekly backup and one for the daily backup. Snapshot files should be replaced when taking full backups, in that case.

More information can be found in the `tar` documentation.

9.1.1.3. Compressing and unpacking with `gzip` or `bzip2`

Data, including tarballs, can be compressed using zip tools. The `gzip` command will add the suffix `.gz` to the file name and remove the original file.

```
jimmy:~> ls -la | grep tar
-rw-rw-r-- 1 jimmy jimmy 61440 Jun 6 14:08 images-without-dir.tar

jimmy:~> gzip images-without-dir.tar

jimmy:~> ls -la images-without-dir.tar.gz
-rw-rw-r-- 1 jimmy jimmy 50562 Jun 6 14:08 images-without-dir.tar.gz
```

Uncompress gzipped files with the `-d` option.

`bzip2` works in a similar way, but uses an improved compression algorithm, thus creating smaller files. See the `bzip2` info pages for more.

Linux software packages are often distributed in a gzipped tarball. The sensible thing to do after unpacking that kind of archives is find the `README` and read it. It will generally contain guidelines to installing the package.

The GNU `tar` command is aware of gzipped files. Use the command

```
tar zxvf file.tar.gz
```

for unzipping and untarring `.tar.gz` or `.tgz` files. Use

```
tar jxvf file.tar.bz2
```

for unpacking `tar` archives that were compressed with `bzip2`.

9.1.1.4. Java archives

The GNU project provides us with the **jar** tool for creating Java archives. It is a Java application that combines multiple files into a single JAR archive file. While also being a general purpose archiving and compression tool, based on ZIP and the ZLIB compression format, **jar** was mainly designed to facilitate the packing of Java code, applets and/or applications in a single file. When combined in a single archive, the components of a Java application, can be downloaded much faster.

Unlike **tar**, **jar** compresses by default, independent from other tools – because it is basically the Java version of **zip**. In addition, it allows individual entries in an archive to be signed by the author, so that origins can be authenticated.

The syntax is almost identical as for the **tar** command, we refer to **info jar** for specific differences.



tar, jar and symbolic links

One noteworthy feature not really mentioned in the standard documentation is that **jar** will follow symbolic links. Data to which these links are pointing will be included in the archive. The default in **tar** is to only backup the symbolic link, but this behavior can be changed using the **-h** to **tar**.

9.1.1.5. Transporting your data

Saving copies of your data on another host is a simple but accurate way of making backups. See [Chapter 10, Communications](#), for more information on **scp**, **ftp** and many more.

In the next section we'll discuss local backup devices.

9.2. Moving your data to a backup device

9.2.1. Making a copy on a floppy disk

9.2.1.1. Formatting the floppy

On most Linux systems, users have access to the floppy disk device. The name of the device may vary depending on the size and number of floppy drives, contact your system admin if you are unsure. On sensibly administered systems, there will likely be a link `/dev/floppy` pointing to the right device, probably `/dev/fd0` (the auto-detecting floppy device) or `/dev/fd0H1440` (set for 1,44MB floppies).

fdformat is the low-level floppy disk formatting tool. It has the device name of the floppy disk as an option. **fdformat** will display an error when the floppy is write-protected.

```
emma:~> fdformat /dev/fd0H1440
Double-sided, 80 tracks, 18 sec/track. Total capacity 1440 kB.
Formatting ... done
Verifying ... done
emma:~>
```

The **mformat** command (from the **mtools** package) is used to create DOS-compatible floppies which can then be accessed using the **mcopy**, **mdir** and other **m-**commands.

Graphical tools are also available.

Figure 9–1. Floppy formatter

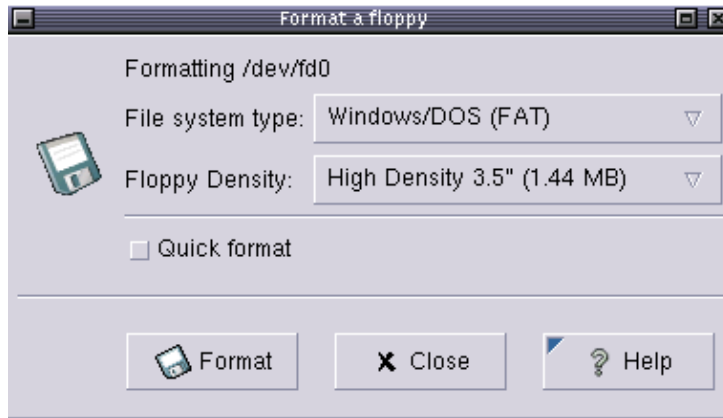

After the floppy is formatted, it can be mounted into the file system and accessed as a normal, be it small, directory, usually via the `/mnt/floppy` entry.

Almost every Linux distribution provides the **mkbootdisk** utility, which makes a floppy from which the current system can boot.

9.2.1.2. Using the `dd` command to dump data

The **dd** command can be used to put data on a disk, or get it off again, depending on the given input and output devices. An example:

```
gaby:~> dd if=images-without-dir.tar.gz of=/dev/fd0H1440
98+1 records in
98+1 records out

gaby:~> dd if=/dev/fd0H1440 of=/var/tmp/images.tar.gz
2880+0 records in
2880+0 records out

gaby:~> ls /var/tmp/images*
/var/tmp/images.tar.gz
```

Note that the dumping is done on an unmounted device. Floppies created using this method will not be mountable in the file system, but it is of course the way to go for creating boot or rescue disks. For more information on the possibilities of **dd**, read the man pages.

This tool is part of the GNU *fileutils* package.

Dumping disks

The **dd** command can also be used to make a raw dump of an entire hard disk.

9.2.2. Making a copy with a CD-writer

On some systems users are allowed to use the CD-writer device. Your data will need to be formatted first. Use the **mkisofs** command to do this in the directory containing the files you want to backup. Check with **df** that enough disk space is available, because a new file about the same size as the entire current directory will be created:

```
[rose@blob recordables] df -h .
Filesystem      Size  Used Avail Use% Mounted on
/dev/hde5       19G   15G  3.2G  82% /home

[rose@blob recordables] du -h -s .
325M   .

[rose@blob recordables] mkisofs -J -r -o cd.iso .
<--snap-->
making a lot of conversions
<--/snap-->
98.95% done, estimate finish Fri Apr  5 13:54:25 2002
Total translation table size: 0
Total rockridge attributes bytes: 35971
Total directory bytes: 94208
Path table size(bytes): 452
Max brk space used 37e84
166768 extents written (325 Mb)
```

The **-J** and **-r** options are used to make the CD-ROM mountable on different systems, see the man pages for more. After that, the CD can be created using the **cdrecord** tool with appropriate options:

```
[rose@blob recordables] cdrecord -dev 0,0,0 -speed=8 cd.iso
Cdrecord 1.10 (i686-pc-linux-gnu) (C) 1995-2001 Joerg Schilling
scsidev: '0,0,0'
scsibus: 0 target: 0 lun: 0
Linux sg driver version: 3.1.20
Using libscg version 'schily-0.5'
Device type      : Removable CD-ROM
Version          : 0
Response Format   : 1
Vendor_info      : 'HP          '
Identification   : 'CD-Writer+ 8100 '
Revision        : '1.0g'
Device seems to be: Generic mmc CD-RW.
Using generic SCSI-3/mmc CD-R driver (mmc_cdr).
Driver flags     : SWABAUDIO
Starting to write CD/DVD at speed 4 in write mode for single session.
Last chance to quit, starting real write in 0 seconds.
Operation starts.
```

Depending on your CD-writer, you now have the time to smoke a cigarette and/or get a cup of coffee. Upon finishing the job, you will get a confirmation message:

```
Track 01: Total bytes read/written: 341540864/341540864
        (166768 sectors).
```

There are some graphical tools available to make it easier on you. One of the popular ones is **xcdroast**, which is freely available from [the X-CD-Roast web site](#) and is included on most systems and in the GNU directory. Both the KDE and Gnome desktop managers have facilities to make your own CDs.

Figure 9–2. X-CD-Roast



Read the man or Info pages describing these commands.

9.2.3. Backups on/from jazz drives, USB devices and such

These devices are usually mounted into the file system. After the mount procedure, they are accessed as normal directories, so you can use the standard commands for manipulating files.

In the example below, images are copied from a USB camera to the hard disk:

```
robin:~> mount /mnt/camera

robin:~> mount | grep camera
/dev/sdal on /mnt/camera type vfat (rw,nosuid,nodev)

robin:~> cp -R /mnt/camera/* images/

robin:~> umount /mnt/camera
```

Likewise, a jazz drive may be mounted on `/mnt/jazz`.

Appropriate lines should be added in `/etc/modules.conf` and `/etc/fstab` to make this work. Refer to specific hardware HOWTOs for more information.

9.2.4. Backing up data using a tape device

This is done using **tar** (see above). The **mt** tool is used for controlling the magnetic tape device, like `/dev/st0`. Entire books have been written about tape backup, therefore, refer to our reading-list in [Appendix B](#) for more information. Keep in mind that databases might need other backup procedures because of their architecture.

The appropriate backup commands are usually put in one of the *cron* directories in order to have them executed on a regular basis. In larger environments, the freely available [Amanda](#) backup suite or a commercial solution may be implemented to back up multiple machines. Working with tapes, however, is a system administration task beyond the scope of this document.

9.2.5. Tools from your distribution

Most Linux distributions offer their own tools for making your life easy. A short overview:

- SuSE: YaST now includes expanded backup and restore modules.
- RedHat: the File Roller tool provides visual management of (compressed) archives. They seem to be in favour of the X-CD-Roast tool for moving backups to an external device.
- Mandrake: X-CD-Roast.
- Most distributions come with the BSD **dump** and **restore** utilities for making backups of *ext2* file systems. This tool can write to a variety of devices and literally dumps the file(s) or file system bit per bit onto the specified device. Like **dd**, this allows for backing up special file types such as the ones in `/dev`.

9.3. Summary

Here's a list of the commands involving file backup:

Table 9–1. Backup commands

Command	Meaning
bzip2	A block-sorting file compressor.
cdrecord	Record audio or data Compact Disks from a master.
dd	Convert and copy a file
fdformat	Low-level formats a floppy disk.
gzip	Compress or expand files.
mcopy	Copy MSDOS files to/from UNIX.
mmdir	Display an MSDOS directory.
mformat	Add an MSDOS file system to a low-level formatted floppy disk.
mkbootdisk	Creates a stand-alone boot floppy for the running system.

mount	Mount a file system (integrate it with the current file system by connecting it to a mount point).
tar	Tape archiving utility, also used for making archives on disk instead of on tape.
umount	Unmount file systems.

9.4. Exercises

- Make a backup copy of your home directory in `/var/tmp` using the **tar** command. Then further compress the file using **gzip** or **bzip2**. Make it a clean tarred file, one that doesn't make a mess when unpacking.
 - Format a floppy and put some files from your home directory on it. Switch floppies with another trainee and recover his/her floppy in your home directory.
 - DOS format the floppy. Use the *mtools* to put and delete files on it.
 - What happens to an unformatted floppy when you want to mount it into the file system?
-

Chapter 10. Networking

When it comes to networking, Linux is your operating system of choice, not only because networking is tightly integrated with the OS itself and a wide variety of free tools and applications are available, but for the robustness under heavy loads that can only be achieved after years of debugging and testing in an Open Source project.

Bookshelves full of information have been written about Linux and networking, but we will try to give an overview in this chapter. After completing this, you will know more about

- ◆ Supported networking protocols
- ◆ File sharing and printing
- ◆ Other common Internet/Intranet services
- ◆ Remote execution of commands and applications
- ◆ Basic network interconnection
- ◆ Networking tools

10.1. Networking Overview

10.1.1. Networking protocols

Linux supports many different networking protocols. We list only the most important:

10.1.1.1. TCP/IP

The Transport Control Protocol and the Internet Protocol are the two most popular ways of communicating on the Internet. A lot of applications, such as your browser and E-mail program, are built on top of this protocol suite.

Very simply put, IP provides a solution for sending packets of information from one machine to another, while TCP ensures that the packets are arranged in streams, so that packets from different applications don't get mixed up, and that the packets are sent and received in the correct order.

The Internet was originally developed three decades ago for the United States Department of Defense (DoD), mainly for the purpose of interconnecting different-brand computers. Another reason for the development of TCP/IP was to provide a reliable data transport system over an unreliable network.

TCP/IP networking has been present in Linux since its beginnings. It has been implemented from scratch. It is one of the most robust, fast and reliable implementations and is one of the key factors of the success of Linux. Linux and networking are made for each other, in so much that not connecting your Linux system to the network may result in slow startup and other troubles. Even if you don't use any network connections to other computers, networking protocols are used for internal system and application communications. Linux expects to be networked.

A good starting point for learning more about TCP and IP is in the following documents:

- **man 7 ip**: Describes the IPv4 protocol implementation on Linux (version 4 currently being the most wide-spread edition of the IP protocol).

- **man 7 tcp**: Implementation of the TCP protocol.
- RFC793, RFC1122, RFC2001 for TCP, and RFC791, RFC1122 and RFC1112 for IP.

The Request For Comments documents contain the descriptions of networking standards, protocols, applications and implementation. These documents are managed by the Internet Engineering Task Force, an international community concerned with the smooth operation of the Internet and the evolution and development of the Internet architecture.

Your ISP usually has an RFC archive available, or you can browse the RFCs via <http://www.ietf.org/rfc.html>.

10.1.1.2. TCP/IPv6

Nobody expected the Internet to grow as fast as it does. IP proved to have quite some disadvantages when a really large number of computers is in a network, the most important being the availability of unique addresses to assign to each machine participating. Thus, IP version 6 was devised to meet the needs of today's Internet.

Unfortunately, not all applications and services support IPv6, yet. A migration is currently being set in motion in many environments that can benefit from an upgrade to IPv6. For some applications, the old protocol is still used, for applications that have been reworked the new version is already active. So when checking your network configuration, sometimes it might be a bit confusing since all kinds of measures can be taken to hide one protocol from the other so as the two don't mix up connections.

More information can be found in the following documents:

- **man 7 ipv6**: the Linux IPv6 protocol implementation.
- RFC1883 describing the IPv6 protocol.

10.1.1.3. PPP, SLIP, PLIP, PPPOE

The Linux kernel has built-in support for PPP (Point-to-Point-Protocol), SLIP (Serial Line IP) and PLIP (Parallel Line IP). PPP is the most popular way individual users access their ISP (Internet Service Provider), although in densely populated areas it is often being replaced by PPPOE, PPP over Ethernet, the protocol used in cable modem connections.

Most Linux distributions provide easy-to-use tools for setting up an Internet connection. The only thing you basically need is a username and password to connect to your Internet Service Provider (ISP), and a telephone number in the case of PPP. These data are entered in the graphical configuration tool, which will likely also allow for starting and stopping the connection to your provider.

10.1.1.4. ISDN

The Linux kernel has built-in ISDN capabilities. Isdn4linux controls ISDN PC cards and can emulate a modem with the Hayes command set ("AT" commands). The possibilities range from simply using a terminal program to full connection to the Internet.

Check your system documentation.

10.1.1.5. AppleTalk

Appletalk is the name of Apple's internetworking stack. It allows a peer-to-peer network model which provides basic functionality such as file and printer sharing. Each machine can simultaneously act as a client and a server, and the software and hardware necessary are included with every Apple computer.

Linux provides full AppleTalk networking. Netatalk is a kernel-level implementation of the AppleTalk Protocol Suite, originally for BSD-derived systems. It includes support for routing AppleTalk, serving UNIX and AFS file systems using AppleShare and serving UNIX printers and accessing AppleTalk printers.

10.1.1.6. SMB/NMB

For compatibility with MS Windows environments, the Samba suite, including support for the NMB and SMB protocols, can be installed on any UNIX-like system. The Server Message Block protocol (also called Session Message Block, NetBIOS or LanManager protocol) is used on MS Windows 3.11, NT, 95/98, 2K and XP to share disks and printers.

The basic functions of the Samba suite are: sharing Linux drives with Windows machines, accessing SMB shares from Linux machines, sharing Linux printers with Windows machines and sharing Windows printers with Linux machines.

Most Linux distributions provide a *samba* package, which does most of the server setup and starts up **smbd**, the Samba server, and **nmbd**, the netbios name server, at boot time by default. Samba can be configured graphically, via a web interface or via the command line and text configuration files. More information can be found at the following locations:

- **man smb.conf**: describes the format of the main Samba configuration file.
 - [The Samba section](#) of the RedHat Support Resources on Printing and File Services.
 - The [Samba Project Documentation](#) (or check your local samba.org mirror) contains an easy to read installation and testing guide, which also explains how to configure your Samba server as a Primary Domain Controller.
 - The [Samba website](#) contains more documentation, including a troubleshooting guide.
-

10.1.1.7. Miscellaneous protocols

Linux also has support for Amateur Radio, WAN internetworking (X25, Frame Relay, ATM), InfraRed and other wireless connections, but since these protocols usually require special hardware, we won't discuss them in this document.

10.1.2. Network configuration and information

10.1.2.1. Configuration of local network interfaces

All the big, userfriendly Linux distributions come with various graphical tools, allowing for easy setup of the computer in a local network or for connecting it to an Internet Service Provider. These tools can be started up from the command line or from a menu:

- RedHat Linux comes with **redhat-config-network**, which has both a graphical and a text mode interface.
- Suse's YAST or YAST2 is an all-in-one configuration tool.

- Mandrake comes with a Network and Internet Configuration Wizard, which is preferably started up from Mandrake's Control Center.

Your system documentation provides plenty of advice and information about availability and use of tools.

Information you'll need to provide:

- For connecting to the local network, for instance with your home computers, or at work: hostname, domainname and IP address. If you want to set up your own network, best do some more reading first. At work, this information is likely to be given to your computer automatically when you boot it up. When in doubt, it is better not to specify any information than making it up.
- For connecting to the Internet: username and password for your ISP, telephone number when using a modem. Your ISP usually automatically assigns you a hostname, IP address and all the other things necessary for your Internet applications to work.

10.1.2.2. Network configuration files

The graphical helper tools edit a specific set of network configuration files, using a couple of basic commands. The exact names of the configuration files and their location in the file system is largely dependent on your Linux distribution and version. However, a couple of network configuration files are common on all UNIX systems:

- `/etc/hosts`: always contains the *localhost* IP address, 127.0.0.1, which is used for interprocess communication. Never remove this line! Sometimes contains addresses of additional hosts, which can be contacted without using an external naming service such as DNS (the Domain Name Server).

A sample `hosts` file for a small home network:

```
# Do not remove the following line, or various programs
# that require network functionality will fail.
127.0.0.1      localhost.localdomain  localhost
192.168.52.10 tux.mylan.com          tux
192.168.52.11 winxp.mylan.com      winxp
```

Read more in **man hosts**.

- `/etc/resolv.conf`: configure access to a DNS server. This file contains your domain name and the name server(s) to contact:

```
search mylan.com
nameserver 193.134.20.4
```

Read more in the `resolv.conf` man page.

- `/etc/nsswitch.conf`: defines the order in which to contact different name services. For Internet use, it is important that *dns* shows up in the "hosts" line:

```
[bob@tux ~] grep hosts /etc/nsswitch.conf
hosts: files dns
```

This instructs your computer to look up hostnames and IP addresses first in the `/etc/hosts` file, and to contact the DNS server if a given host does not occur in the local `hosts` file. Other possible name services to contact are LDAP, NIS and NIS+.

More in **man nsswitch.conf**.

10.1.2.3. Network configuration commands

The distribution-specific scripts and graphical tools use **ip** (or **ifconfig** and **route** on older systems) to configure the kernel's networking configuration.

The **ip** command is used for assigning IP addresses to interfaces, for setting up routes to the Internet and to other networks, for displaying TCP/IP configurations etcetera.

The following commands show IP address and routing information:

```
benny@home benny> ip addr show
1: lo: <LOOPBACK,UP> mtu 16436 qdisc noqueue
   link/loopback 00:00:00:00:00:00 brd 00:00:00:00:00:00
   inet 127.0.0.1/8 brd 127.255.255.255 scope host lo
   inet6 ::1/128 scope host
2: eth0: <BROADCAST,MULTICAST,UP> mtu 1500 qdisc pfifo_fast qlen 100
   link/ether 00:50:bf:7e:54:9a brd ff:ff:ff:ff:ff:ff
   inet 192.168.42.15/24 brd 192.168.42.255 scope global eth0
   inet6 fe80::250:bfff:fe7e:549a/10 scope link

benny@home benny> ip route show
192.168.42.0/24 dev eth0 scope link
127.0.0.0/8 dev lo scope link
default via 192.168.42.1 dev eth0
```

On your laptop which you usually connect to the company network using the onboard Ethernet connection, but which you are now to configure for dial-in at home or in a hotel, you might need to activate the PCMCIA card. This is done using the **cardctl** control utility. However, a good distribution should provide PCMCIA support in the network configuration tools, preventing users from having to execute PCMCIA commands manually.

Further discussion of network configuration is out of the scope of this document. Your primary source for extra information is the man pages for the services you want to set up. Additional reading:

- **The Modem-HOWTO**: Help with selecting, connecting, configuring, trouble-shooting, and understanding analog modems for a PC.
- **LDP HOWTO Index, section 4.4**: categorized list of HOWTOs about general networking, protocols, dial-up, DNS, VPNs, bridging, routing, security and more.
- The `/usr/share/doc/iproute-<version>ip-cref.ps` file, viewable with for instance **gv**.

10.1.2.4. Network interface names

On a Linux machine, the device name *lo* or the *local loop* is linked with the internal 127.0.0.1 address. The computer will have a hard time making your applications work if this device is not present; it is always there, even on computers which are not networked.

The first ethernet device, *eth0* in the case of a standard network interface card, points to your local LAN IP address. Normal client machines only have one network interface card. Routers, connecting networks together, have one network device for each network they serve.

If you use a modem to connect to the Internet, your network device will probably be named *ppp0*. This is normally also the case for connections using a cable modem.

10.1.2.5. Your host configuration

Apart from the **ip** command for displaying the network configuration, there's the common **netstat** command which has a lot of options and is generally useful on any UNIX system. Use the **-i** option to display information about network interfaces:

```
bob:~> netstat -i
Kernel Interface table
Iface MTU Met RXOK RXERR RX-DRP RX-OVR TX-OK TX-ERR TX-DRP TX-OVR Flg
eth0 1500 0 58459 0 0 0 63865 0 0 0 BMRU
lo 16436 0 24060 0 0 0 24060 0 0 0 LRU
```

Routing information can be displayed with the **-nr** option to the **netstat** command:

```
bob:~> netstat -nr
Kernel IP routing table
Destination Gateway Genmask Flags MSS Window irtt Iface
192.168.42.0 0.0.0.0 255.255.255.0 U 40 0 0 eth0
127.0.0.0 0.0.0.0 255.0.0.0 U 40 0 0 lo
0.0.0.0 192.168.42.1 0.0.0.0 UG 40 0 0 eth0
```

This is a typical client machine in an IP network. It only has one network device, *eth0*. The *lo* interface is the local loop.

10.1.2.6. Other hosts

An impressive amount of tools is focused on network management and remote administration of Linux machines. Your local Linux software mirror will offer plenty of those. It would lead us too far to discuss them in this document, so please refer to the program-specific documentation.

We will only discuss some common UNIX/Linux text tools in this section.

To display information on hosts or domains, use the **host** command:

```
[emmy@pc10 emmy]$ host www.eunet.be
www.eunet.be. has address 193.74.208.177

[emmy@pc10 emmy]$ host -t any eunet.be
eunet.be. SOA dns.eunet.be. hostmaster.Belgium.EU.net.
2002021300 28800 7200 604800 86400
eunet.be. mail is handled by 50 pophost.eunet.be.
eunet.be. name server ns.EU.net.
eunet.be. name server dns.eunet.be.
```

Similar information can be displayed using the **dig** command, which gives additional information about how records are stored in the name server.

To check if a host is alive, use **ping**. If your system is configured to send more than one packet, interrupt **ping** with the **Ctrl+C** key combination:

Introduction to Linux

```
[emmy@pc10 emmy]$ ping a.host.be
PING a.host.be (1.2.8.3) from 80.20.84.26: 56(84) bytes of data.
64 bytes from a.host.be(1.2.8.3):icmp_seq=0 ttl=244 time=99.977msec
--- a.host.be ping statistics ---
1 packets transmitted, 1 packets received, 0% packet loss
round-trip min/avg/max/mdev = 99.977/99.977/99.977/0.000 ms
```

To check the route that packets follow to a network host, use the **traceroute** command:

```
[emmy@pc10 emmy]$ /usr/sbin/traceroute www.eunet.be
traceroute to www.eunet.be(193.74.208.177),30 hops max,38b packets
1 blob (10.0.0.1)
  0.297ms 0.257ms 0.174ms
2 adsl-65.myprovider.be (217.136.111.1)
  12.120ms 13.058ms 13.009ms
3 194.78.255.177 (194.78.255.177)
  13.845ms 14.308ms 12.756ms
4 gigabitethernet2-2.intl2.gam.brussels.skynet.be (195.238.2.226)
  13.123ms 13.164ms 12.527ms
5 pecbru2.car.belbone.be (194.78.255.118)
  16.336ms 13.889ms 13.028ms
6 ser-2-1-110-ias-be-vil-ar01.kpnbelgium.be (194.119.224.9)
  14.602ms 15.546ms 15.959ms
7 unknown-195-207-939.eunet.be (195.207.93.49)
  16.514ms 17.661ms 18.889ms
8 S0-1-0.Leuven.Belgium.EU.net (195.207.129.1)
  22.714ms 19.193ms 18.432ms
9 dukat.Belgium.EU.net (193.74.208.178) 22.758ms * 25.263ms
```

Specific domain name information can be queried using the **whois** command, as is explained by many **whois** servers, like the one below:

```
[emmy@pc10 emmy]$ whois cnn.com
[whois.crsnic.net]

Whois Server Version 1.3

    $<--snap server message-->

Domain Name: CNN.COM
Registrar: NETWORK SOLUTIONS, INC.
Whois Server: whois.networksolutions.com
Referral URL: http://www.networksolutions.com
Name Server: TWDNS-01.NS.AOL.COM
Name Server: TWDNS-02.NS.AOL.COM
Name Server: TWDNS-03.NS.AOL.COM
Name Server: TWDNS-04.NS.AOL.COM
Updated Date: 12-mar-2002
>>> Last update of whois database: Fri, 5 Apr 2002 05:04:55 EST <<<

The Registry database contains ONLY .COM, .NET, .ORG, .EDU domains
and Registrars.

[whois.networksolutions.com]

    $<--snap server message-->

Registrant:
Turner Broadcasting (CNN-DOM)
  1 CNN Center
```

```

Atlanta, GA 30303

Domain Name: CNN.COM

Administrative Contact:
    $<--snap contactinfo-->
Technical Contact:
    $<--snap contactinfo-->
Billing Contact:
    $<--snap contactinfo-->
Record last updated on 12-Mar-2002.
Record expires on 23-Sep-2009.
Record created on 22-Sep-1993.
Database last updated on 4-Apr-2002 20:10:00 EST.

Domain servers in listed order:

TWDNS-01.NS.AOL.COM          149.174.213.151
TWDNS-02.NS.AOL.COM          152.163.239.216
TWDNS-03.NS.AOL.COM          205.188.146.88
TWDNS-04.NS.AOL.COM          64.12.147.120

```

For other domain names than .com, .net, .org and .edu, specify the whois server, such as this one for .be domains:

whois domain.be@whois.dns.be

10.2. Internet/Intranet applications

The Linux system is a great platform for offering networking services. In this section, we will try to give an overview of most common network servers and applications.

10.2.1. Server types

10.2.1.1. Standalone server

Offering a service to users can be approached in two ways. A daemon or service can run in standalone mode, or it can be dependent on another service to be activated.

Network services that are heavily and/or continuously used, usually run in the standalone mode: they are independent program daemons that are always running. They are most likely started up at system boot time, and they wait for requests on the specific connection points or ports for which they are set up to listen. When a request comes, it is processed, and the listening continues until the next request. A web server is a typical example: you want it to be available 24 hours a day, and if it is too busy it should create more listening instances to serve simultaneous users. Other examples are the large software archives such as [Sourceforge](#) or [your Tucows mirror](#), which must handle thousands of FTP requests per day.

An example of a standalone network service on your home computer might be the **named**, a caching name server. Standalone services have their own processes running, you can check any time using **ps**:

```

bob:~> ps auxw | grep named
named  908  0.0  1.0 14876 5108 ?    S   Mar14  0:07 named -u named

```

Most services on your home PC, such as the FTP service, don't have a running daemon, yet you can use them:

```
bob:~> ps auxw | grep ftp
bob      738    690    0 16:17 pts/6      00:00:00 grep ftp

bob:~> ncftp localhost
NcFTP 3.1.3 (Mar 27, 2002) by Mike Gleason (ncftp@ncftp.com).
Connecting to localhost(127.0.0.1)...
myhost.my.org FTP server (Version wu-2.6.2-8) ready.
Logging in...
Guest login ok, access restrictions apply.
Logged in to localhost.
ncftp / >
```

Let's see in the next section how this is arranged.

10.2.1.2. (x)inetd

On your home PC, things are usually a bit calmer. You may have a small network, for instance, and you may have to transfer files from one PC to another from time to time, using FTP or Samba (for connectivity with MS Windows machines). In those cases, starting all the services which you only need occasionally and having them run all the time would be a waste of resources. So in smaller setups, you will find the necessary daemons dependent on a central program, that listen on all the ports of the services for which it is responsible.

This super-server, the Internet services daemon, is started up at system initialization time. There are two common implementations: **inetd** and **xinetd** (the extended Internet services daemon). One or the other is usually running on every Linux system:

```
bob:~> ps -ef | grep inet
root  926    1 0 Mar14 ?    00:00:00 xinetd-ipv6 -stayalive -reuse \
-pidfile /var/run/xinetd.pid
```

The services for which the Internet daemon is responsible, are listed in its configuration file, `/etc/inetd.conf`, for **inetd**, and in the directory `/etc/xinetd.d` for **xinetd**. Commonly managed services include file share and print services, SSH, FTP, telnet, the Samba configuration daemon, talk and time services.

As soon as a connection request is received, the central server will start an instance of the required server. Thus, in the example below, when user *bob* starts an FTP session to the local host, an FTP daemon is running as long as the session is active:

```
bob:~> ps auxw | grep ftp
bob      793  0.1  0.2  3960 1076 pts/6      S    16:44    0:00 ncftp localhost
ftp      794  0.7  0.5  5588 2608 ?          SN   16:44    0:00 ftpd:
localhost.localdomain: anonymous/bob@his.server.com: IDLE
```

Of course, the same happens when you open connections to remote hosts: either a daemon answers directly, or a remote **(x)inetd** starts the service you need and stops it when you quit.

10.2.2. Mail

10.2.2.1. Servers

Sendmail is the standard mail server program or Mail Transport Agent for UNIX platforms. It is robust, scalable, and when properly configured with appropriate hardware, handles thousands of users without blinking. More information about how to configure Sendmail is included with the `sendmail` and `sendmail-cf` packages, you may want to read the `README` and `README.cf` files in `/usr/share/doc/sendmail`. The `man sendmail` and `man aliases` are also useful.

Qmail is another mail server, gaining popularity because it claims to be more secure than Sendmail. While Sendmail is a monolithic program, Qmail consists of smaller interacting program parts that can be better secured.

These servers handle mailing lists, filtering, virus scanning and much more. Free and commercial scanners are available for use with Linux. Examples of mailing list software are Mailman, Listserv, Majordomo and EZmlm. See the web page of your favorite virus scanner for information on Linux client and server support.

10.2.2.2. Remote mail servers

The most popular protocols to access mail remotely are *POP3* and *IMAP4*. IMAP and POP both allow offline operation, remote access to new mail and they both rely on an SMTP server to send mail.

While POP is a simple protocol, easy to implement and supported by almost any mail client, IMAP is preferred because:

- It can manipulate persistent message status flags.
- It can store as well as fetch mail messages.
- It can access and manage multiple mailboxes.
- It supports concurrent updates and shared mailboxes.
- It is also suitable for accessing Usenet messages and other documents.
- IMAP works both on-line and off-line.
- it is optimized for on-line performance, especially over low-speed links.

10.2.2.3. Mail user-agents

There are plenty of both text and graphical E-mail clients, we'll just name a few of the common ones. Pick your favorite.

The UNIX `mail` command has been around for years, even before networking existed. It is a simple interface to send messages and small files to other users, who can then save the message, redirect it, reply to it and such.

While it is not commonly used as a client anymore, the `mail` program is still useful, for example to mail the output of a command to somebody:

```
mail <future.employer@whereIwant2work.com> <cv.txt
```

The `elm` mail reader is a much needed improvement to `mail`, and so is `pine` (Pine Is Not ELM). The `mutt` mail reader is even more recent and offers features like threading.

For those users who prefer a graphical interface to their mail (and a tennis elbow or a mouse arm), there are hundreds of options. The most popular for new users are Mozilla Mail and the Ximian MS Exchange clone, Evolution, of which you can see a screenshot below:

Figure 10–1. Evolution mail and news reader

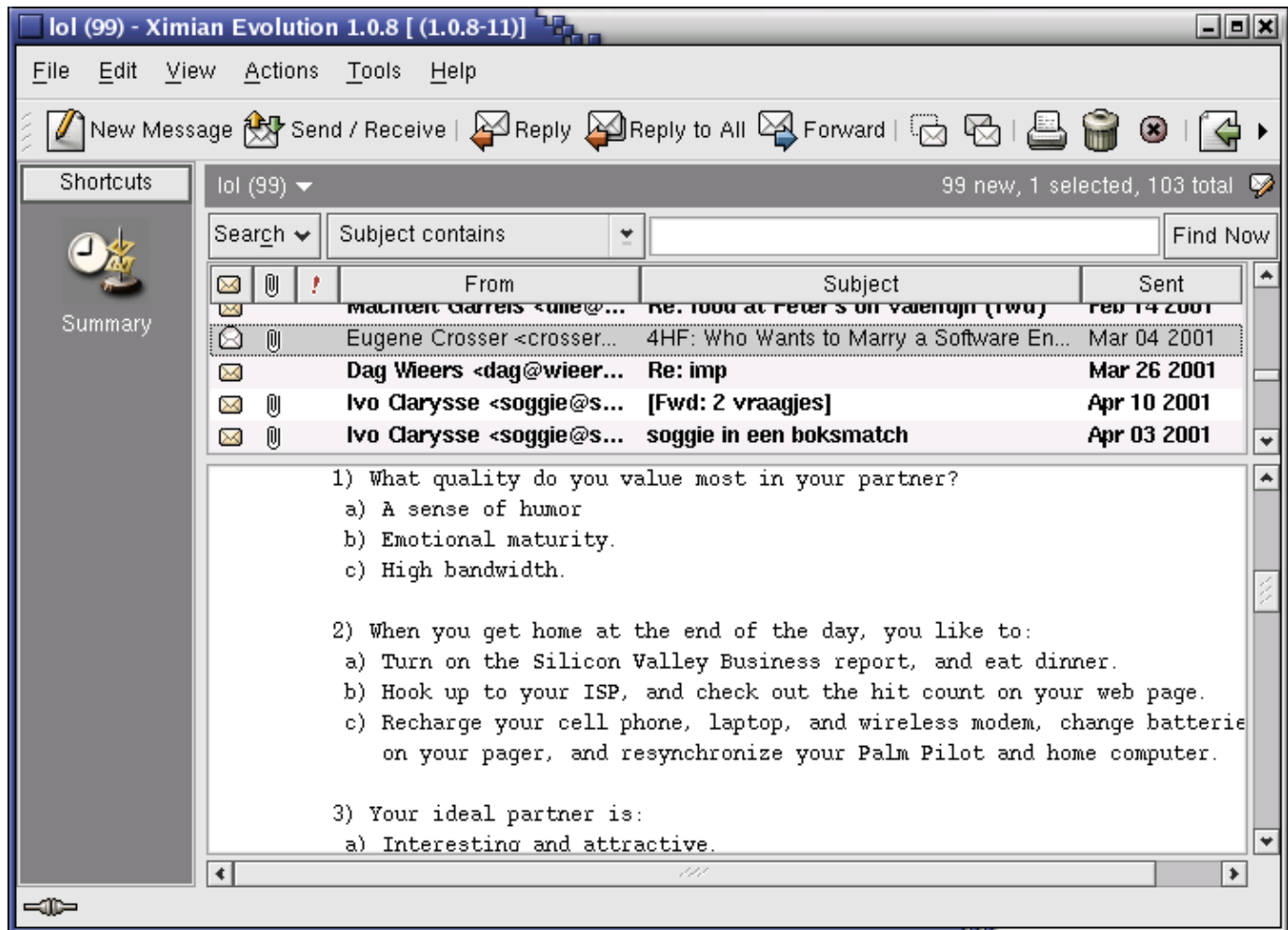

There are also tens of web mail applications available.

An overview is available via the [Linux Mail User HOWTO](#).

Most Linux distributions include **fetchmail**, a mail–retrieval and forwarding utility. It fetches mail from remote mail servers (POP, IMAP and some others) and forwards it to your local delivery system. You can then handle the retrieved mail using normal mail clients. It can be run in daemon mode to repeatedly poll one or more systems at a specified interval. Information and usage examples can be found in the Info pages; the directory `/usr/share/doc/fetchmail-<version>` contains a full list of features and a FAQ for beginners.

The **procmail** filter can be used for filtering incoming mail, to create mailing lists, to pre–process mail, to selectively forward mail and more. The accompanying **formail** program, among others, enables generation of auto–replies and splitting up mailboxes. Procmail has been around for years on UNIX and Linux machines and is a very robust system, designed to work even in the worst circumstances. More information may be

found in the `/usr/share/doc/procmail-<version>` directory and in the man pages.

10.2.3. Web

10.2.3.1. The Apache Web Server

Apache is by far the most popular web server, used on more than half of all Internet web servers. Most Linux distributions include Apache. Apache's advantages include its modular design, SSL support, stability and speed. Given the appropriate hardware and configuration it can support the highest loads.

On Linux systems, the server configuration is usually done in the `/etc/httpd` directory. The most important configuration file is `httpd.conf`; it is rather self-explanatory. Should you need help, you can find it in the **httpd** man page or on the [Apache website](#).

10.2.3.2. Web browsers

A number of web browsers, both free and commercial, exist for the Linux platform. Netscape Navigator has long been the only decent option, but with Mozilla a competitive alternative is available.

Amaya is the W3C browser. Opera is a commercial browser, compact and fast. Many desktop managers offer web browsing features in their file manager, like **nautilus**.

Among the popular text based browsers are **lynx** and **links**. You may need to define proxy servers in your shell, by setting the appropriate variables. Text browsers are fast and handy when no graphical environment is available, such as when used in scripts.

10.2.4. File Transfer Protocol

10.2.4.1. FTP servers

On a Linux system, an FTP server is typically run from **xinetd**, using the `WU-ftp` server, although the FTP server may be configured as a stand-alone server on systems with heavy FTP traffic. See the exercises.

Other FTP servers include among others `Ncftpd` and `Proftpd`.

Most Linux distributions contain the `anonftp` package, which sets up an anonymous FTP server tree and accompanying configuration files.

10.2.4.2. FTP clients

Most Linux distributions include **ncftp**, an improved version of the common UNIX **ftp** command, which you may also know from the Windows command line. The **ncftp** program offers extra features such as a nicer and more comprehensible user interface, file name completion, append and resume functions, bookmarking, session management and more:

```
thomas:~> ncftp blob
NcFTP 3.0.3 (April 15, 2001) by Mike Gleason (ncftp@ncftp.com).
Connecting to blob...
blob.some.net FTP server (Version wu-2.6.1-20) ready.
Logging in...
Guest login ok, access restrictions apply.
```



```
Logged in to blob.
ncftp / > help
Commands may be abbreviated. 'help showall' shows hidden and
unsupported commands.
'help <command>' gives a brief description of <command>.

ascii      cat        help       lpage     open      quote     site
bgget      cd         jobs       lpwd      page      rename    type
bgput      chmod     lcd        lrename   pdir      rhelp     umask
bgstart    close     lchmod     lrm       pls       rm        version
binary     debug     lls        lrmdir    put       rmdir
bookmark   dir       lmkdir     ls        pwd       set
bookmarks  get       lookup     mkdir     quit      show
ncftp / >
```

Excellent help with lot of examples can be found in the man pages. And again, a number of GUI applications are available.

FTP is insecure!

Don't use the File Transfer Protocol for non-anonymous login unless you know what you are doing. Your user name and password might be captured by malevolent fellow network users! Use secure FTP instead; the **sftp** program comes with the Secure SHell suite, see [Section 10.3.4](#).

10.2.5. Chatting and conferencing

Various clients and systems are available in each distribution. A short and incomplete list of the most popular programs:

- **gaim**: multi-protocol instant messaging client for Linux, Windows and Mac, compatible with MSN Messenger, ICQ, IRC and much more; see the Info pages or [the Gaim site](#) for more.
- **xchat**: IRC client for the X window system:

Figure 10–2. X-Chat

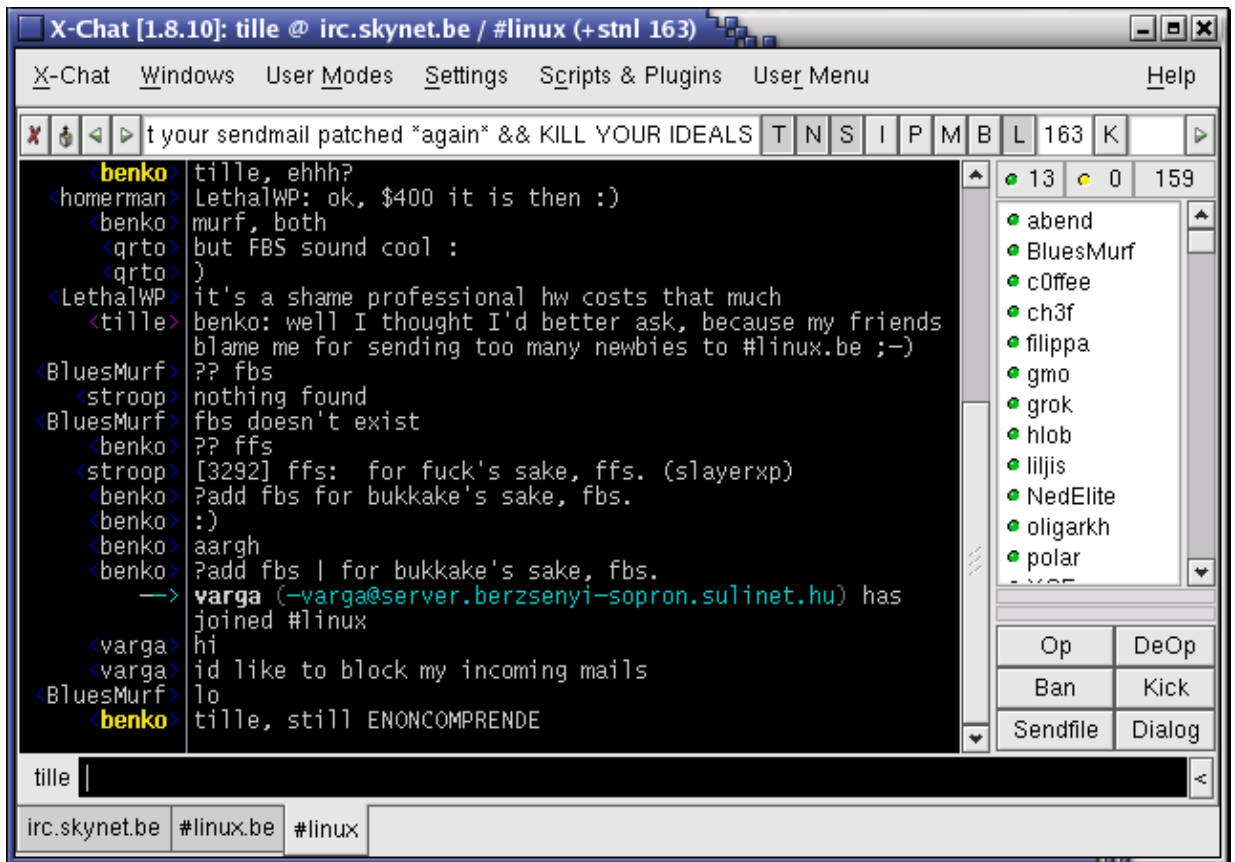

The home page is at [SourceForge](#).

- **JMSN**: Java MSN Messenger clone with many features that the original does not have.
- **Konversation**, **KVIrc** and many other K–tools from the KDE suite.
- **gnomemeeting**: videoconferencing program for UNIX.

10.2.6. News services

Running a Usenet server involves a lot of expertise and fine–tuning, so refer to the [INN homepage](#) for more information.

There are a couple of interesting newsgroups in the *comp.** hierarchy, which can be accessed using a variety of text and graphical clients. A lot of mail clients support newsgroup browsing as well, check your program or see your local Open Source software mirror for text clients such as **tin**, **slrnn** and **mutt**, or download Mozilla or one of a number of other graphical clients.

[Deja.com](#) keeps a searchable archive of all newsgroups, powered by Google. This is a very powerful instrument for getting help: chances are very high that somebody has encountered your problem, found a solution and posted it in one of the newsgroups.

10.2.7. The Domain Name System

All these applications need DNS services to match IP addresses to host names and vice versa. A DNS server does not know all the IP addresses in the world, but networks with other DNS servers which it can query to find an unknown address. Most UNIX systems can run **named**, which is part of the bind (Berkeley Internet

Name Domain) package distributed by the Internet Software Consortium. It can run as a stand-alone caching *nameserver*, which is often done on Linux systems in order to speed up network access.

Your main client configuration file is `/etc/resolv.conf`, which determines the order in which Domain Name Servers are contacted:

```
search somewhere.org
nameserver 192.168.42.1
nameserver 193.74.208.137
```

More information can be found in the Info pages on **named**, in the `/usr/share/doc/bind-<version>` files and on the [Bind project](#) homepage. The [DNS HOWTO](#) covers the use of BIND as a DNS server.

10.2.8. DHCP

DHCP is the Dynamic Host Configuration Protocol, which is gradually replacing good old **bootp** in larger environments. It is used to control vital networking parameters such as IP addresses and name servers of hosts. DHCP is backward compatible with **bootp**. For configuring the server, you will need to read the HOWTO.

DHCP client machines will usually be configured using a GUI that configures the **dhcpcd**, the DHCP client daemon. Check your system documentation if you need to configure your machine as a DHCP client.

10.2.9. Authentication services

10.2.9.1. Traditional

Traditionally, users are authenticated locally, using the information stored in `/etc/passwd` and `/etc/shadow` on each system. But even when using a network service for authenticating, the local files will always be present to configure system accounts for administrative use, such as the root account, the daemon accounts and often accounts for additional programs and purposes.

These files are often the first candidates for being examined by hackers, so make sure the permissions and ownerships are strictly set as should be:

```
bob:~> ls -l /etc/passwd /etc/shadow
-rw-r--r--  1 root    root      1803 Mar 10 13:08 /etc/passwd
-r-----  1 root    root      1116 Mar 10 13:08 /etc/shadow
```

10.2.9.2. PAM

Linux can use PAM, the Pluggable Authentication Module, a flexible method of UNIX authentication. Advantages of PAM:

- A common authentication scheme that can be used with a wide variety of applications.
- PAM can be implemented with various applications without having to recompile the applications to specifically support PAM.
- Great flexibility and control over authentication for the administrator and application developer.
- Application developers do not need to develop their program to use a particular authentication

scheme. Instead, they can focus purely on the details of their program.

The directory `/etc/pam.d` contains the PAM configuration files (used to be `/etc/pam.conf`). Each application or service has its own file. Each line in the file has four elements:

- *Module*:
 - ◆ `auth`: provides the actual authentication (perhaps asking for and checking a password) and sets credentials, such as group membership or Kerberos tickets.
 - ◆ `account`: checks to make sure that access is allowed for the user (the account has not expired, the user is allowed to log in at this time of day, and so on).
 - ◆ `password`: used to set passwords.
 - ◆ `session`: used after a user has been authenticated. This module performs additional tasks which are needed to allow access (for example, mounting the user's home directory or making their mailbox available).
- The order in which modules are stacked, so that multiple modules can be used, is very important.
- *Control Flags*: tell PAM which actions to take upon failure or success. Values can be `required`, `requisite`, `sufficient` or `optional`.
 - *Module Path*: path to the pluggable module to be used, usually in `/lib/security`.
 - *Arguments*: information for the modules

Shadow password files are automatically detected by PAM.

More information can be found in the **pam** man pages or at [the Linux-PAM project homepage](#).

10.2.9.3. LDAP

The Lightweight Directory Access Protocol is a client-server system for accessing global or local directory services over a network. On Linux, the OpenLDAP implementation is used. It includes **slapd**, a stand-alone server; **slurpd**, a stand-alone LDAP replication server; libraries implementing the LDAP protocol and a series of utilities, tools and sample clients.

The main benefit of using LDAP is the consolidation of certain types of information within your organization. For example, all of the different lists of users within your organization can be merged into one LDAP directory. This directory can be queried by any LDAP-enabled applications that need this information. It can also be accessed by users who need directory information.

Other LDAP or X.500 Lite benefits include its ease of implementation (compared to X.500) and its well-defined Application Programming Interface (API), which means that the number of LDAP-enabled applications and LDAP gateways should increase in the future.

On the negative side, if you want to use LDAP, you will need LDAP-enabled applications or the ability to use LDAP gateways. While LDAP usage should only increase, currently there are not very many LDAP-enabled applications available for Linux. Also, while LDAP does support some access control, it does not possess as many security features as X.500.

Since LDAP is an open and configurable protocol, it can be used to store almost any type of information relating to a particular organizational structure. Common examples are mail address lookups, central authentication in combination with PAM, telephone directories and machine configuration databases.

See your system specific information and the man pages for related commands such as **ldapmodify** and **ldapsearch** for details. More information can be found in the [LDAP Linux HOWTO](#), which discusses installation, configuration, running and maintenance of an LDAP server on Linux. The [LDAP Implementation HOWTO](#) describes the technical aspects of storing application data in an LDAP server. The author of this Introduction to Linux document also wrote an [LDAP Operations HOWTO](#), describing the basics everyone should know about when dealing with LDAP management, operations and integration of services.

10.3. Remote execution of applications

10.3.1. Introduction

There are a couple of different ways to execute commands or run programs on a remote machine and have the output, be it text or graphics, sent to your workstation. The connections can be secure or insecure. While it is of course advised to use secure connections instead of transporting your password over the network unencrypted, we will discuss some practical applications of the older (unsafe) mechanisms, as they are still useful in a modern networked environment, such as for troubleshooting or running exotic programs.

10.3.2. Rsh, rlogin and telnet

The **rlogin** and **rsh** commands for remote login and remote execution of commands are inherited from UNIX. While seldom used because they are blatantly insecure, they still come with almost every Linux distribution for backward compatibility with UNIX programs.

Telnet, on the other hand, is still commonly used, often by system and network administrators. Telnet is one of the most powerful tools for remote access to files and remote administration, allowing connections from anywhere on the Internet. Combined with an X server, remote graphical applications can be displayed locally. There is no difference between working on the local machine and using the remote machine.

Because the entire connection is unencrypted, allowing **telnet** connections involves taking high security risks. For normal remote execution of programs, Secure SHell or **ssh** is advised. We will discuss the secure method later in this section.

However, **telnet** is still used in many cases. Below are some examples in which a mail server and a web server are tested for replies:

Checking that a mail server works:

```
[jimmy@blob ~] telnet mailserver 25
Trying 192.168.42.1...
Connected to mailserver.
Escape character is '^]'.
220 m1.some.net ESMTP Sendmail 8.11.6/8.11.6; 200302281626
ehlo some.net
250-m1.some.net Hello blob.some.net [10.0.0.1], pleased to meet you
250-ENHANCEDSTATUSCODES
250-8BITMIME
250-SIZE
250-DSN
250-ONEX
250-ETRN
250-XUSR
250 HELP
```

```
mail from: jimmy@some.net
250 2.1.0 jimmy@some.net... Sender ok
rcpt to: davy@some.net
250 2.1.5 davy@some.net... Recipient ok
data
354 Enter mail, end with "." on a line by itself
test
.
250 2.0.0 g2MA1R619237 Message accepted for delivery
quit
221 2.0.0 ml.some.net closing connection
Connection closed by foreign host.
```

Checking that a web server answers to basic requests:

```
[jimmy@blob ~] telnet www.some.net 80
Trying 64.39.151.23...
Connected to www.some.net.
Escape character is '^]'.
HEAD / ;HTTP/1.1

HTTP/1.1 200 OK
Date: Fri, 22 Mar 2002 10:05:14 GMT
Server: Apache/1.3.22 (UNIX) (Red-Hat/Linux)
 mod_ssl/2.8.5 OpenSSL/0.9.6
 DAV/1.0.2 PHP/4.0.6 mod_perl/1.24_01
Last-Modified: Fri, 04 Jan 2002 08:21:00 GMT
ETag: "70061-68-3c3565ec"
Accept-Ranges: bytes
Content-Length: 104
Connection: close
Content-Type: text/html

Connection closed by foreign host.

[jimmy@blob ~]
```

This is perfectly safe, because you never have to give a username and/or password for getting the data you want, so nobody can snoop that important information off the cable.

10.3.3. The X Window System

10.3.3.1. X features

As we already explained in Chapter 7 (see [Section 7.3.3](#)), the X Window system comes with an X server which serves graphics to clients that need a display.

It is important to realize the distinction between the X server and the X client application(s). The X server controls the display directly and is responsible for all input and output via keyboard, mouse and display. The X client, on the other hand, does not access the input and output devices directly. It communicates with the X server which handles input and output. It is the X client which does the real work, like computing values, running applications and so forth. The X server only opens windows to handle input and output for the specified client.

In normal operation (runlevel five, graphical mode), every Linux workstation is an X server to itself, even if it only runs client applications. All the applications you are running (for example, Gimp, a terminal window,

your browser, your office application, your CD playing tool, and so on) are clients to your X server. Server and client are running on the same machine in this case.

This client/server nature of the X system makes it an ideal environment for remote execution of applications and programs. Because the process is actually being executed on the remote machine, very little CPU power is needed on the local host. Such machines, purely acting as servers for X, are called X terminals and were once very popular. More information may be found in the [Remote X applications mini-HOWTO](#).

10.3.3.2. Telnet and X

If you would want to use **telnet** to display graphical applications running on a remote machine, you first need to give the remote machine access to your display (to your X server!) using the **xhost** command, by typing a command similar to the one below in a terminal window on your local machine:

```
davy:~> xhost +remote.machine.com
```

After that, connect to the remote host and tell it to display graphics on the local machine by setting the environment variable `DISPLAY`:

```
[davy@remote ~] export DISPLAY="local.host.com:0.0"
```

After completing this step, any application started in this terminal window will be displayed on your local desktop, using remote resources for computing, but your local graphical resources (your X server) for displaying the application.

This procedure assumes that you have some sort of X server (XFree86, Exceed, Cygwin) already set up on the machine where you want to display images. The architecture and operating system of the client machine are not important as long as they allow you to run an X server on it.

Mind that displaying a terminal window from the remote machine is also considered to be a display of an image.

10.3.4. The SSH suite

10.3.4.1. Introduction

Most UNIX and Linux systems now run Secure SHell in order to leave out the security risks that came with **telnet**. Most Linux systems will run a version of OpenSSH, an Open Source implementation of the SSH protocol, providing secure encrypted communications between untrusted hosts over an untrusted network. In the standard setup X connections are automatically forwarded, but arbitrary TCP/IP ports may also be forwarded using a secure channel.

The **ssh** client connects and logs into the specified host name. The user must provide his identity to the remote machine as specified in the `sshd_config` file, which can usually be found in `/etc/ssh`. The configuration file is rather self-explanatory and by defaults enables most common features. Should you need help, you can find it in the **sshd** man pages.

When the user's identity has been accepted by the server, the server either executes the given command, or logs into the machine and gives the user a normal shell on the remote machine. All communication with the remote command or shell will be automatically encrypted.

Introduction to Linux

The session terminates when the command or shell on the remote machine exits and all X11 and TCP/IP connections have been closed.

When connecting to a host for the first time, using any of the programs that are included in the SSH collection, you need to establish the authenticity of that host and acknowledge that you want to connect:

```
lenny ~> ssh blob
The authenticity of host 'blob (10.0.0.1)' can't be established.
RSA fingerprint is 18:30:50:46:ac:98:3c:93:1a:56:35:09:8d:97:e3:1d.
Are you sure you want to continue connecting (yes/no)? yes
Warning: Permanently added 'blob,192.168.30.2' (RSA) to the list of
known hosts.
Last login: Sat Dec 28 13:29:19 2002 from octarine
This space for rent.

lenny is in ~
```

It is important that you type "yes", in three characters, not just "y". This edits your `~/.ssh/known_hosts` file, see [Section 10.3.4.3](#).

If you just want to check something on a remote machine and then get your prompt back on the local host, you can give the commands that you want to execute remotely as arguments to **ssh**:

```
lenny ~> ssh blob who
jenny@blob's password:
root    tty2      Jul 24 07:19
lena    tty3      Jul 23 22:24
lena    0:        Jul 25 22:03

lenny ~> uname -n
magrat.example.com
```

10.3.4.2. X11 and TCP forwarding

If the `X11Forwarding` entry is set to *yes* and the user is using X applications, the `DISPLAY` environment variable is set, the connection to the X11 display is automatically forwarded to the remote side in such a way that any X11 programs started from the shell will go through the encrypted channel, and the connection to the real X server will be made from the local machine. The user should not manually set `DISPLAY`. Forwarding of X11 connections can be configured on the command line or in the **sshd** configuration file.

The value for `DISPLAY` set by **ssh** will point to the server machine, but with a display number greater than zero. This is normal, and happens because **ssh** creates a *proxy* X server on the server machine (that runs the X client application) for forwarding the connections over the encrypted channel.

This is all done automatically, so when you type in the name of a graphical application, it is displayed on your local machine and not on the remote host. We use **xclock** in the example, since it is a small program which is generally installed and ideal for testing:

Figure 10–3. SSH X11 forwarding

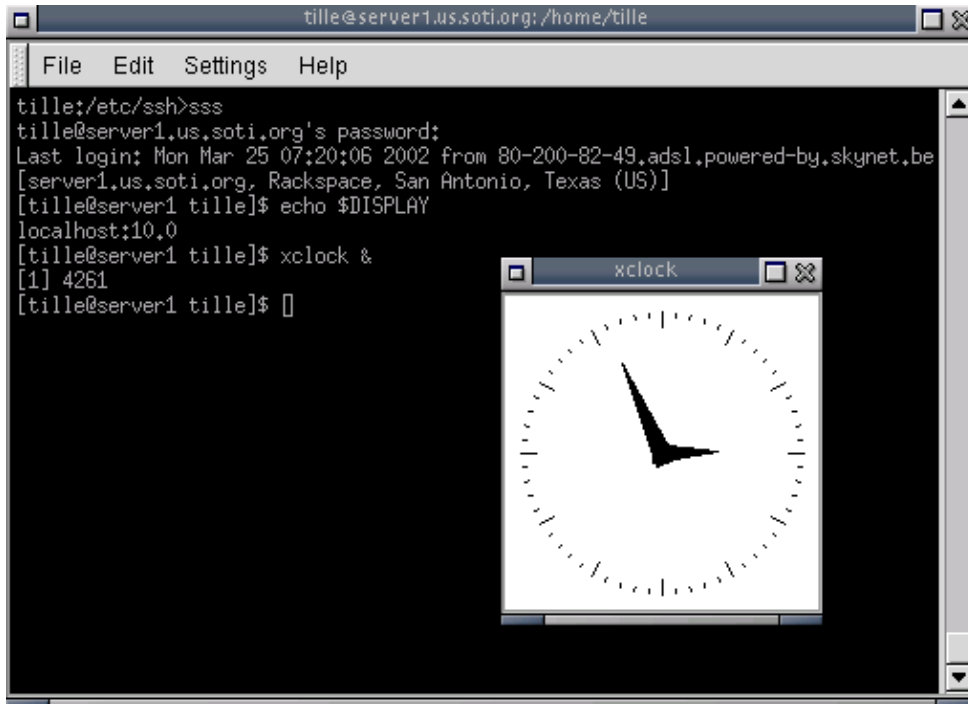

SSH will also automatically set up Xauthority data on the server machine. For this purpose, it will generate a random authorization cookie, store it in `Xauthority` on the server, and verify that any forwarded connections carry this cookie and replace it by the real cookie when the connection is opened. The real authentication cookie is never sent to the server machine (and no cookies are sent in the plain).

Forwarding of arbitrary TCP/IP connections over the secure channel can be specified either on the command line or in a configuration file.

The X server

This procedure assumes that you have a running X server on the client where you want to display the application from the remote host. The client may be of different architecture and operating system than the remote host, as long as it can run an X server, such as Cygwin (which implements an XFree86 server for MS Windows clients and others) or Exceed, it should be possible to set up a remote connection with any Linux or UNIX machine.

10.3.4.3. Server authentication

The `ssh` client/server system automatically maintains and checks a database containing identifications for all hosts it has ever been used with. Host keys are stored in `$HOME/.ssh/known_hosts` in the user's home directory. Additionally, the file `/etc/ssh/ssh_known_hosts` is automatically checked for known hosts. Any new hosts are automatically added to the user's file. If a host's identification ever changes, `ssh` warns about this and disables password authentication to prevent a Trojan horse from getting the user's password. Another purpose of this mechanism is to prevent man-in-the-middle attacks which could otherwise be used to circumvent the encryption. In environments where high security is needed, `sshd` can even be configured to prevent logins to machines whose host keys have changed or are unknown.

10.3.4.4. Secure remote copying

The SSH suite provides **scp** as a secure alternative to the **rcp** command that used to be popular when only **rsh** existed. **scp** uses **ssh** for data transfer, uses the same authentication and provides the same security as **ssh**. Unlike **rcp**, **scp** will ask for passwords or passphrases if they are needed for authentication:

```
lenny /var/tmp> scp Schedule.sdc.gz blob:/var/tmp/
lenny@blob's password:
Schedule.sdc.gz 100% |*****| 100 KB 00:00

lenny /var/tmp>
```

Any file name may contain a host and user specification to indicate that the file is to be copied to/from that host. Copies between two remote hosts are permitted. See the Info pages for more information.

If you would rather use an FTP-like interface, use **sftp**:

```
lenny /var/tmp> sftp blob
Connecting to blob...
lenny@blob's password:

sftp> cd /var/tmp

sftp> get Sch*
Fetching /var/tmp/Schedule.sdc.gz to Schedule.sdc.gz

sftp> bye

lenny /var/tmp>
```

10.3.4.5. Authentication keys

The **ssh-keygen** command generates, manages and converts authentication keys for **ssh**. It can create RSA keys for use by SSH protocol version 1 and RSA or DSA keys for use by SSH protocol version 2.

Normally each user wishing to use SSH with RSA or DSA authentication runs this once to create the authentication key in `$HOME/.ssh/identity`, `id_dsa` or `id_rsa`. Additionally, the system administrator may use this to generate host keys for the system.

Normally this program generates the key and asks for a file in which to store the private key. The public key is stored in a file with the same name but `.pub` appended. The program also asks for a passphrase. The passphrase may be empty to indicate no passphrase (host keys must have an empty passphrase), or it may be a string of arbitrary length.

There is no way to recover a lost passphrase. If the passphrase is lost or forgotten, a new key must be generated and copied to the corresponding public keys.

We will study SSH keys in the exercises. All information can be found in the man or Info pages.

10.3.5. VNC

VNC or Virtual Network Computing is in fact a remote display system which allows viewing a desktop environment not only on the local machine on which it is running, but from anywhere on the Internet and from a wide variety of machines and architectures, including MS Windows and several UNIX distributions. You could, for example, run MS Word on a Windows NT machine and display the output on your Linux desktop. VNC provides servers as well as clients, so the opposite also works and it may thus be used to display Linux programs on Windows clients. VNC is probably the easiest way to have X connections on a PC. The following features make VNC different from a normal X server or commercial implementations:

- No state is stored at the viewer side: you can leave your desk and resume from another machine, continuing where you left. When you are running a PC X server, and the PC crashes or is restarted, all remote applications that you were running will die. With VNC, they keep on running.
- It is small and simple, no installation needed, can be run from a floppy if needed.
- Platform independent with the Java client, runs on virtually everything that supports X.
- Sharable: one desktop may be displayed on multiple viewers.
- Free (GNU Public License).

More information can be found in the VNC client man pages (`man vncviewer`) or on the [VNC website](#).

10.4. Security

10.4.1. Introduction

As soon as a computer is connected to the network, all kinds of abuse becomes possible, be it a UNIX-based or any other system. Admittedly, mountains of papers have been spilled on this subject and it would lead us too far to discuss the subject of security in detail. There are, however, a couple of fairly logical things even a novice user can do to obtain a very secure system, because most break-ins are the result of ignorant or careless users.

Maybe you are asking yourself if this all applies to you, using your computer at home or working at your office on a desktop in a fairly protected environment. The questions you should be asking yourself, however, are more on the lines of:

- Do you want to be in control of your own system?
- Do you want to (unwittingly) participate in criminal activities?
- Do you want your equipment to be used by someone else?
- Do you want to take risks on losing your Internet connection?
- Do you want to rebuild your system every time it has been hacked?
- Do you want to risk personal or other data loss?

Presuming you don't, we will quickly list the steps you can take to secure your machine. Extended information can be found in the [Linux Security HOWTO](#).

10.4.2. Services

The goal is to run as few services as possible. If the number of ports that are open for the outside world are kept to a minimum, this is all the better to keep an overview. If services can't be turned off for the local network, try to at least disable them for outside connections.

A rule of thumb is that if you don't recognize a particular service, you probably won't need it anyway. Also keep in mind that some services are not really meant to be used over the Internet. Don't rely on what *should* be running, check which services are listening on what TCP ports using the **netstat** command:

```
[elly@mars ~] netstat -l | grep tcp
tcp      0      0 *:*32769          *:*      LISTEN
tcp      0      0 *:*32771          *:*      LISTEN
tcp      0      0 *:*printer        *:*      LISTEN
tcp      0      0 *:*kerberos_master *:*      LISTEN
tcp      0      0 *:*sunrpc          *:*      LISTEN
tcp      0      0 *:*6001            *:*      LISTEN
tcp      0      0 *:*785             *:*      LISTEN
tcp      0      0 localhost.localdom:smtp *:*      LISTEN
tcp      0      0 *:*ftp             *:*      LISTEN
tcp      0      0 *:*ssh             *:*      LISTEN
tcp      0      0 *:*:1:x11-ssh-offset *:*      LISTEN
```

Things to avoid:

- **exec**, **rlogin** and **rsh**, and **telnet** just to be on the safe side.
- X11 on server machines.
- No lp if no printer is physically attached.
- No MS Windows hosts in the network, no Samba required.
- Don't allow FTP unless an FTP server is required.
- Don't allow NFS and NIS over the Internet, disable all related services on a stand-alone installation.
- Don't run an MTA if you're not actually on a mail server.
- ...

Stop running services using the **chkconfig** command, the **initscripts** or by editing the **(x)inetd** configuration files.

10.4.3. Update regularly

Its ability to adapt quickly in an ever changing environment is what makes Linux thrive. But it also creates a possibility that security updates have been released even while you are installing a brand new version, so the first thing you should do (and this goes for about any OS you can think of) after installing is getting the updates as soon as possible. After that, update *all* the packages you use regularly.

Some updates may require new configuration files, and old files may be replaced. Check the documentation, and ensure that everything runs normal after updating.

Most Linux distributions provide mailing list services for security update announcements, and tools for applying updates to the system. General Linux only security issues are reported among others at Linuxsecurity.com.

Updating is an ongoing process, so it should be an almost daily habit.

10.4.4. Firewalls and access policies

10.4.4.1. What is a firewall?

In the previous section we already mentioned firewall capabilities in Linux. While firewall administration is one of the tasks of your network admin, you should know a couple of things about firewalls.

Firewall is a vague term that can mean anything that acts as a protective barrier between us and the outside world, generally the Internet. A firewall can be a dedicated system or a specific application that provides this functionality. Or it can be a combination of components, including various combinations of hardware and software. Firewalls are built from "rules" that are used to define what is allowed to enter and/or exit a given system or network.

After disabling unnecessary services, we now want to restrict accepted services as to allow only the minimum required connections. A fine example is working from home: only the specific connection between your office and your home should be allowed, connections from other machines on the Internet should be blocked.

10.4.4.2. Packet filters

The first line of defense is a *packet filter*, which can look inside IP packages and make decisions based on the content. Systems running the **ipchains** firewall are based on 2.2 kernels. Newer systems (2.4 kernel) use **iptables**, a next generation packet filter for Linux, and the Gnome Lokkit tool. This tool was only created to provide an easy interface for normal users. It sets up a basic firewall configuration for a desktop, a dial-up or cable modem connection, and that's about it. It should not be used in larger environments.

One of the most noteworthy enhancements in the newer kernels is the *stateful inspection* feature, which not only tells what is inside a packet, but also detects if a packet belongs or is related to a new or existing connection.

Development is ongoing, so it is best to check with each new version of a distribution which system is being used.

More information can be found at [the netfilter/iptables project page](#).

10.4.4.3. TCP wrappers

TCP wrapping provides much the same results as the packet filters, but works differently. The wrapper actually accepts the connection attempt, then examines configuration files and decides whether to accept or reject the connection request. It controls connections at the application level rather than at the network level.

TCP wrappers are typically used with **xinetd** to provide host name and IP-address-based access control. In addition, these tools include logging and utilization management capabilities that are easy to configure.

The advantages of TCP wrappers are that the connecting client is unaware that wrappers are used, and that they operate separately from the applications they protect.

The host based access is controlled in the `hosts.allow` and `hosts.deny` files. More information can be found in the TCP wrapper documentation files in `/usr/share/doc/tcp_wrappers-<version>/` and in the man pages for the host based access control files, which contain examples.

10.4.4.4. Proxies

Proxies can perform various duties, not all of which have much to do with security. But the fact that they are an intermediary make proxies a good place to enforce access control policies, limit direct connections through a firewall, and control how the network behind the proxy looks to the Internet.

Usually in combination with a packet filter, but sometimes all by themselves, proxies provide an extra level of control. More information can be found in the [Firewall HOWTO](#) or on the Squid website.

10.4.4.5. Access to individual applications

Some servers may have their own access control features. Common examples include Samba, X11, Bind, Apache and CUPS. For every service you want to offer check which configuration files apply.

10.4.4.6. Log files

If anything, the UNIX way of logging all kinds of activities into all kinds of files confirms that "it is doing something." Of course, log files should be checked regularly, manually or automatically. Firewalls and other means of access control tend to create huge amounts of log files, so the trick is to try and only log abnormal activities.

10.4.5. Intrusion detection

Intrusion Detection Systems are designed to catch what might have gotten past the firewall. They can either be designed to catch an active break-in attempt in progress, or to detect a successful break-in after the fact. In the latter case, it is too late to prevent any damage, but at least we have early awareness of a problem. There are two basic types of IDS: those protecting networks, and those protecting individual hosts.

For host based IDS, this is done with utilities that monitor the file system for changes. System files that have changed in some way, but should not change, are a dead give-away that something is amiss. Anyone who gets in and gets root access will presumably make changes to the system somewhere. This is usually the very first thing done, either so he can get back in through a backdoor, or to launch an attack against someone else, in which case, he has to change or add files to the system. Some systems come with the **tripwire** monitoring system, which is documented at the [Tripwire Open Source Project](#) website.

Network intrusion detection is handled by a system that sees all the traffic that passes the firewall (not by portscanners, which advertise usable ports). [Snort](#) is an Open Source example of such a program. Whitehats.com features an open Intrusion detection database, [arachNIDS](#).

10.4.6. More tips

Some general things you should keep in mind:

- Do not allow root logins. UNIX developers came up with the **su** over two decades ago for extra security.
- Take passwords seriously. Use shadow passwords. Change your passwords regularly.
- Try to always use SSH. Avoid **telnet**, FTP clients, and other client programs, such as a POP3 mail client, which send unencrypted passwords over the network.
- Limit resources using **quota** and/or **ulimit**.
- The mail for root should be delivered to, or at least read by, an actual person.

- The [SANS institute](#) has more tips and tricks, sorted per distribution, with mailing list service. They advertise the use of the [Bastille hardening system](#) for RedHat users.
 - Check the origin of new software, get it from a trusted place/site. Verify new packages before installing.
 - When using a non-permanent Internet connection, shut it down as soon as you don't need it anymore.
 - Run private services on odd ports instead of the ones expected by possible hackers.
 - Know your system. After a while, you can almost feel when something is happening.
-

10.4.7. Have I been hacked?

How can you tell? This is a checklist of suspicious events:

- Mysterious open ports, strange processes.
 - System utilities (common commands) behaving strange.
 - Login problems.
 - Unexplained bandwidth usage.
 - Damaged or missing log files, syslog daemon behaving strange.
 - Interfaces in unusual modes.
 - Unexpectedly modified configuration files.
 - Strange entries in shell history files.
 - Unidentified temporary files.
-

10.4.8. Recovering from intrusion

In short, stay calm. Then take the following actions in this order:

- Disconnect the machine from the network.
 - Try to find out as much as you can about how your security was breached.
 - Backup important non-system data.
 - Re-install the system.
 - Use new passwords.
 - Restore from system and data backups.
 - Apply all available updates.
 - Re-examine the system: block off unnecessary services, check firewall rules and other access policies.
 - Reconnect.
-

10.5. Summary

Linux and networking go hand in hand. The Linux kernel has support for all common and most uncommon network protocols. The standard UNIX networking tools are provided in each distribution. Next to those, most distributions offer tools for easy network installation and management.

Linux is well known as a stable platform for running various Internet services, the amount of Internet software is endless. Like UNIX, Linux can be just as well used and administered from a remote location, using one of several solutions for remote execution of programs.

We briefly touched the subject of security. Linux is an ideal firewall system, light and cheap, but can be used in several other network functions such as routers and proxy servers.

Increasing network security is mainly done by applying frequent updates and common sense.

10.6. Exercises

10.6.1. General networking

- Display network information for your workstation: IP address, routes, name servers.
 - Suppose no DNS is available. What would you do to reach your neighbour's machine without typing the IP address all the time?
 - How would you permanently store proxy information for a text mode browser such as **links**?
 - Which name servers handle the redhat.com domain?
 - Send an E-mail to your local account. Try two different ways to send and read it. How can you check that it really arrived?
 - Does your machine accept anonymous FTP connections? How do you use the **ncftp** program to authenticate with your user name and password?
 - Does your machine run a web server? If not, make it do so. Check the log files!
-

10.6.2. Remote connections

- From your local workstation, display a graphical application, such as **xclock** on your neighbour's screen. The necessary accounts will have to be set up. Use a secure connection!
 - Set up SSH keys so you can connect to your neighbour's machine without having to enter a password.
 - Make a backup copy of your home directory in `/var/tmp` on your neighbour's "backup server," using **scp**. Archive and compress before starting the data transfer! Connect to the remote host using **ssh**, unpack the backup, and put one file back on the original machine using **sftp**.
-

10.6.3. Security

- Make a list of open (listening) ports on your machine.
 - Supposing you want to run a web server. Which services would you deactivate? How would you do that?
 - Install available updates.
 - How can you see who connected to your system?
 - Make a repetitive job that reminds you to change your password every month, and preferably the *root* password as well.
-

Appendix A. Where to go from here?

This document gives an overview of useful books and sites.

A.1. Useful Books

A.1.1. General Linux

- "Linux in a Nutshell" by Ellen Siever, Jessica P. Hackman, Stephen SPainhour, Stephen Figgins, O'Reilly UK, ISBN 0596000251
 - "Running Linux" by Matt Welsh, Matthias Kalle Dalheimer, Lar Kaufman, O'Reilly UK, ISBN 156592469X
 - "Linux Unleashed" by Tim Parker, Bill Ball, David Pitts, Sams, ISBN 0672316889
 - "When You Can't Find Your System Administrator" by Linda Mui, O'Reilly UK, ISBN 1565921046
 - When you actually buy a distribution, it will contain a very decent user manual.
-

A.1.2. Editors

- "Learning the Vi Editor" by Linda Lamb and Arnold Robbins, O'Reilly UK, ISBN 1565924266
 - "GNU Emacs Manual" by Richard M.Stallman, iUniverse.Com Inc., ISBN 0595100333
 - "Learning GNU Emacs" by Debra Cameron, Bill Rosenblatt and Eric Raymond, O'Reilly UK, ISBN 1565921526
 - "Perl Cookbook" by Tom Christiansen and Nathan Torkington, O'Reilly UK, ISBN 1565922433
-

A.1.3. Shells

- "Unix Shell Programming" by Stephen G.Kochan and Patrick H.Wood, Sams Publishing, ISBN 067248448X
 - "Learning the Bash Shell" by Cameron Newham and Bill Rosenblatt, O'Reilly UK, ISBN 1565923472
 - "The Complete Linux Shell Programming Training Course" by Ellie Quigley and Scott Hawkins, Prentice Hall PTR, ISBN 0130406767
 - "Linux and Unix Shell Programming" by David Tansley, Addison Wesley Publishing Company, ISBN 0201674726
 - "Unix C Shell Field Guide" by Gail and Paul Anderson, Prentice Hall, ISBN 013937468X
-

A.1.4. X Windows

- "Gnome User's Guide" by the Gnome Community, iUniverse.Com Inc., ISBN 0595132251
- "KDE Bible" by Dave Nash, Hungry Minds Inc., ISBN 0764546929
- "The Concise Guide to XFree86 for Linux" by Aron HSiao, Que, ISBN 0789721821
- "The New XFree86" by Bill Ball, Prima Publishing, ISBN 0761531521
- "Beginning GTK+ and Gnome" by Peter Wright, Wrox Press, ISBN 1861003811
- "KDE 2.0 Development" by David Sweet and Matthias Ettrich, Sams Publishing, ISBN 0672318911
- "GTK+/Gnome Application Development" by Havoc Pennington, New Riders Publishing, ISBN 0735700788

A.1.5. Networking

- "TCP/IP Illustrated, Volume I: The Protocols" by W. Richard Stevens, Addison–Wesley Professional Computing Series, ISBN 0–201–63346–9
 - "DNS and BIND" by Paul Albitz, Cricket Liu, Mike Loukides and Deborah Russell, O'Reilly & Associates, ISBN 0596001584
 - "The Concise Guide to DNS and BIND" by Nicolai Langfeldt, Que, ISBN 0789722739
 - "Implementing LDAP" by Mark Wilcox, Wrox Press, ISBN 1861002211
 - "Understanding and deploying LDAP directory services" by Tim Howes and co., Sams, ISBN 0672323168
 - "Sendmail" by Brian Costales and Eric Allman, O'Reilly UK, ISBN 1565922220
 - "Removing the Spam : Email Processing and Filtering" by Geoff Mulligan, Addison Wesley Publishing Company, ISBN 0201379570
 - "Managing IMAP" by Dianna & Kevin Mullet, O'Reilly UK, ISBN 059600012X
-

A.2. Useful sites

A.2.1. General information

- [The Linux documentation project](#): all docs, manpages, HOWTOs, FAQs
 - [Google for Linux](#): the specialized search engine
 - [Deja](#): an archive of all newsgroup postings, including the comp.os.linux hierarchy
 - [Slashdot](#): daily news
 - <http://www.oreilly.com>: books on Linux System and Network administration, Perl, Java, ...
 - [POSIX](#): the standard
 - [Linux HQ](#): Maintains a complete database of source, patches and documentation for various versions of the Linux kernel.
-

A.2.2. Architecture Specific References

- [Linux PPC](#): Linux on a Power PC (e.g. Apple PowerPC, PowerMac, Amiga, IBM ThinkPad/PowerSeries/RS/6000, Motorola...)
 - [AlphaLinux](#): Linux on Alpha architecture (e.g. Digital Workstation)
 - [Linux–MIPS](#): Linux on MIPS (e.g. SGI Indy)
 - [Laptop HOWTO](#): Specific guidelines for installing and running Linux on laptops, configuration files for various models.
 - [MkLinux](#): Linux on Apple
-

A.2.3. Distributions

- [The Fedora Project](#): RedHat–sponsored community effort OS.
- [Mandrake](#)
- [Debian](#)
- [TurboLinux](#)
- [Slackware](#)
- [SuSE](#)
- [LinuxISO.org](#): CD images for all distributions.

- [Knoppix](#): distribution that runs from a CD, you don't need to install anything for this one.
 - [Distrowatch.com](#): find a Linux that goes with your style.
 - ...
-

A.2.4. Software

- [Freshmeat](#): new software, software archives
 - [OpenSSH](#): Secure SHell site
 - [OpenOffice](#): MS compatible Office Suite
 - [KDE](#): K Desktop site
 - [GNU](#): GNU and GNU software
 - [Gnome](#): The official Gnome site
 - [Ximian](#): Ximian Gnome, Red Carpet package management system for StarOffice, Opera, CodeWeavers, Loki Demos, Evolution, system packages, ...
 - [RPM Find](#): all RPM packages
 - [Samba](#): MS Windows file and print services
 - [Home of the OpenLDAP Project](#): OpenLDAP server/clients/utilities, FAQ and other documentation.
 - [Sendmail Homepage](#): A thorough technical discussion of Sendmail features, includes configuration examples.
 - [Netfilter](#): contains assorted information about iptables: HOWTO, FAQ, guides, ...
 - [Official GIMP website](#): All information about the GNU Image Manipulation Program.
 - [SourceForge.net](#): Open SOURCE software development site.
 - [vIm homepage](#)
-

Appendix B. DOS versus Linux commands

In this appendix, we matched DOS commands with their Linux equivalent.

As an extra means of orientation for new users with a Windows background, the table below lists MS-DOS commands with their Linux counterparts. Keep in mind that Linux commands usually have a number of options. Read the Info or man pages on the command to find out more.

Table B-1. Overview of DOS/Linux commands

DOS commands	Linux command
<command> /?	man <command>
cd	cd
chdir	pwd
cls	clear
copy	cp
date	date
del	rm
dir	ls
echo	echo
edit	vim (or other editor)
exit	exit
fc	diff
find	grep
format	mke2fs or mformat
mem	free
mkdir	mkdir
more	more or even less
move	mv
ren	mv
time	date

Appendix C. Shell Features

This document gives an overview of common shell features (the same in every shell flavour) and differing shell features (shell specific features).

C.1. Common features

The following features are standard in every shell. Note that the stop, suspend, jobs, bg and fg commands are only available on systems that support job control.

Table C–1. Common Shell Features

Command	Meaning
>	Redirect output
>>	Append to file
<	Redirect input
<<	"Here" document (redirect input)
	Pipe output
&	Run process in background.
;	Separate commands on same line
*	Match any character(s) in filename
?	Match single character in filename
[]	Match any characters enclosed
()	Execute in subshell
` `	Substitute output of enclosed command
" "	Partial quote (allows variable and command expansion)
' '	Full quote (no expansion)
\	Quote following character
\$var	Use value for variable
\$\$	Process id
\$0	Command name
\$n	nth argument (n from 0 to 9)
\$*	All arguments as a simple word
#	Begin comment
bg	Background execution
break	Break from loop statements
cd	Change directories
continue	Resume a program loop
echo	Display output
eval	Evaluate arguments
exec	Execute a new shell

fg	Foreground execution
jobs	Show active jobs
kill	Terminate running jobs
newgrp	Change to a new group
shift	Shift positional parameters
stop	Suspend a background job
suspend	Suspend a foreground job
time	Time a command
umask	Set or list file permissions
unset	Erase variable or function definitions
wait	Wait for a background job to finish

C.2. Differing features

The table below shows major differences between the standard shell (**sh**), Bourne Again SHell (**bash**), Korn shell (**ksh**) and the C shell (**csh**).



Shell compatibility

Since the Bourne Again SHell is a superset of **sh**, all **sh** commands will also work in **bash** – but not vice versa. **bash** has many more features of its own, and, as the table below demonstrates, many features incorporated from other shells.

Since the Turbo C shell is a superset of **csh**, all **csh** commands will work in **tcsh**, but not the other way round.

Table C–2. Differing Shell Features

sh	bash	ksh	csh	Meaning/Action
\$	\$	\$	%	Default user prompt
	>	>	>!	Force redirection
> file 2>&1	&> file or > file 2>&1	> file 2>&1	>& file	Redirect stdout and stderr to file
	{ }		{ }	Expand elements in list
`command`	`command` or \$(command)	\$(command)	`command`	Substitute output of enclosed command
\$HOME	\$HOME	\$HOME	\$home	Home directory
	~	~	~	Home directory symbol
	~+, ~-, dirs	~+, ~-	=-, =N	Access directory stack

Introduction to Linux

var=value	VAR=value	var=value	set var=value	Variable assignment
export var	export VAR=value	export var=val	setenv var val	Set environment variable
	<code>\${nnnn}</code>	<code>\${nn}</code>		More than 9 arguments can be referenced
<code>"\$@"</code>	<code>"\$@"</code>	<code>"\$@"</code>		All arguments as separate words
<code>\$#</code>	<code>\$#</code>	<code>\$#</code>	<code>\$#argv</code>	Number of arguments
<code>\$?</code>	<code>\$?</code>	<code>\$?</code>	<code>\$status</code>	Exit status of the most recently executed command
<code>\$!</code>	<code>\$!</code>	<code>\$!</code>		PID of most recently backgrounded process
<code>\$-</code>	<code>\$-</code>	<code>\$-</code>		Current options
. file	source file or . file	. file	source file	Read commands in file
	alias x='y'	alias x=y	alias x y	Name x stands for command y
case	case	case	switch or case	Choose alternatives
done	done	done	end	End a loop statement
esac	esac	esac	endsw	End case or switch
exit n	exit n	exit n	exit (expr)	Exit with a status
for/do	for/do	for/do	foreach	Loop through variables
	set -f , set -o nullglob dotglob nocaseglob noglob		noglob	Ignore substitution characters for filename generation
hash	hash	alias -t	hashstat	Display hashed commands (tracked aliases)
hash cmds	hash cmds	alias -t cmds	rehash	Remember command locations
hash -r	hash -r		unhash	Forget command locations

	history	history	history	List previous commands
	ArrowUp+Enter or !!	r	!!	Redo previous command
	!<i>str</i>	r <i>str</i>	!<i>str</i>	Redo last command that starts with "str"
	!<i>cmd:s/x/y/</i>	r <i>x=y cmd</i>	!<i>cmd:s/x/y/</i>	Replace "x" with "y" in most recent command starting with "cmd", then execute.
if [\$i -eq 5]	if [\$i -eq 5]	if ((i==5))	if (\$i==5)	Sample condition test
fi	fi	fi	endif	End if statement
ulimit	ulimit	ulimit	limit	Set resource limits
pwd	pwd	pwd	dirs	Print working directory
read	read	read	\$<	Read from terminal
trap 2	trap 2	trap 2	onintr	Ignore interrupts
	unalias	unalias	unalias	Remove aliases
until	until	until		Begin until loop
while/do	while/do	while/do	while	Begin while loop

The Bourne Again SHell has many more features not listed here. This table is just to give you an idea of how this shell incorporates all useful ideas from other shells: there are no blanks in the column for **bash**. More information on features found only in Bash can be retrieved from the Bash info pages, in the "Bash Features" section.

More information:

You should at least read one manual, being the manual of your shell. The preferred choice would be **info bash**, **bash** being the GNU shell and easiest for beginners. Print it out and take it home, study it whenever you have 5 minutes.

See [Appendix B](#) if you are having difficulties to assimilate shell commands.

Appendix D. GNU Free Documentation License

Version 1.1, March 2000

Copyright (C) 2000 Free Software Foundation, Inc. 59 Temple Place, Suite 330, Boston, MA 02111-1307 USA Everyone is permitted to copy and distribute verbatim copies of this license document, but changing it is not allowed.

D.1. Preamble

The purpose of this License is to make a manual, textbook, or other written document "free" in the sense of freedom: to assure everyone the effective freedom to copy and redistribute it, with or without modifying it, either commercially or noncommercially. Secondly, this License preserves for the author and publisher a way to get credit for their work, while not being considered responsible for modifications made by others.

This License is a kind of "copyleft", which means that derivative works of the document must themselves be free in the same sense. It complements the GNU General Public License, which is a copyleft license designed for free software.

We have designed this License in order to use it for manuals for free software, because free software needs free documentation: a free program should come with manuals providing the same freedoms that the software does. But this License is not limited to software manuals; it can be used for any textual work, regardless of subject matter or whether it is published as a printed book. We recommend this License principally for works whose purpose is instruction or reference.

D.2. Applicability and definitions

This License applies to any manual or other work that contains a notice placed by the copyright holder saying it can be distributed under the terms of this License. The "Document", below, refers to any such manual or work. Any member of the public is a licensee, and is addressed as "you".

A "Modified Version" of the Document means any work containing the Document or a portion of it, either copied verbatim, or with modifications and/or translated into another language.

A "Secondary Section" is a named appendix or a front-matter section of the Document that deals exclusively with the relationship of the publishers or authors of the Document to the Document's overall subject (or to related matters) and contains nothing that could fall directly within that overall subject. (For example, if the Document is in part a textbook of mathematics, a Secondary Section may not explain any mathematics.) The relationship could be a matter of historical connection with the subject or with related matters, or of legal, commercial, philosophical, ethical or political position regarding them.

The "Invariant Sections" are certain Secondary Sections whose titles are designated, as being those of Invariant Sections, in the notice that says that the Document is released under this License.

The "Cover Texts" are certain short passages of text that are listed, as Front-Cover Texts or Back-Cover Texts, in the notice that says that the Document is released under this License.

A "Transparent" copy of the Document means a machine-readable copy, represented in a format whose specification is available to the general public, whose contents can be viewed and edited directly and straightforwardly with generic text editors or (for images composed of pixels) generic paint programs or (for drawings) some widely available drawing editor, and that is suitable for input to text formatters or for automatic translation to a variety of formats suitable for input to text formatters. A copy made in an otherwise Transparent file format whose markup has been designed to thwart or discourage subsequent modification by readers is not Transparent. A copy that is not "Transparent" is called "Opaque".

Examples of suitable formats for Transparent copies include plain ASCII without markup, Texinfo input format, LaTeX input format, SGML or XML using a publicly available DTD, and standard-conforming simple HTML designed for human modification. Opaque formats include PostScript, PDF, proprietary formats that can be read and edited only by proprietary word processors, SGML or XML for which the DTD and/or processing tools are not generally available, and the machine-generated HTML produced by some word processors for output purposes only.

The "Title Page" means, for a printed book, the title page itself, plus such following pages as are needed to hold, legibly, the material this License requires to appear in the title page. For works in formats which do not have any title page as such, "Title Page" means the text near the most prominent appearance of the work's title, preceding the beginning of the body of the text.

D.3. Verbatim copying

You may copy and distribute the Document in any medium, either commercially or noncommercially, provided that this License, the copyright notices, and the license notice saying this License applies to the Document are reproduced in all copies, and that you add no other conditions whatsoever to those of this License. You may not use technical measures to obstruct or control the reading or further copying of the copies you make or distribute. However, you may accept compensation in exchange for copies. If you distribute a large enough number of copies you must also follow the conditions in section 3.

You may also lend copies, under the same conditions stated above, and you may publicly display copies.

D.4. Copying in quantity

If you publish printed copies of the Document numbering more than 100, and the Document's license notice requires Cover Texts, you must enclose the copies in covers that carry, clearly and legibly, all these Cover Texts: Front-Cover Texts on the front cover, and Back-Cover Texts on the back cover. Both covers must also clearly and legibly identify you as the publisher of these copies. The front cover must present the full title with all words of the title equally prominent and visible. You may add other material on the covers in addition. Copying with changes limited to the covers, as long as they preserve the title of the Document and satisfy these conditions, can be treated as verbatim copying in other respects.

If the required texts for either cover are too voluminous to fit legibly, you should put the first ones listed (as many as fit reasonably) on the actual cover, and continue the rest onto adjacent pages.

If you publish or distribute Opaque copies of the Document numbering more than 100, you must either include a machine-readable Transparent copy along with each Opaque copy, or state in or with each Opaque copy a publicly-accessible computer-network location containing a complete Transparent copy of the Document, free of added material, which the general network-using public has access to download anonymously at no charge using public-standard network protocols. If you use the latter option, you must

take reasonably prudent steps, when you begin distribution of Opaque copies in quantity, to ensure that this Transparent copy will remain thus accessible at the stated location until at least one year after the last time you distribute an Opaque copy (directly or through your agents or retailers) of that edition to the public.

It is requested, but not required, that you contact the authors of the Document well before redistributing any large number of copies, to give them a chance to provide you with an updated version of the Document.

D.5. Modifications

You may copy and distribute a Modified Version of the Document under the conditions of sections 2 and 3 above, provided that you release the Modified Version under precisely this License, with the Modified Version filling the role of the Document, thus licensing distribution and modification of the Modified Version to whoever possesses a copy of it. In addition, you must do these things in the Modified Version:

- A. Use in the Title Page (and on the covers, if any) a title distinct from that of the Document, and from those of previous versions (which should, if there were any, be listed in the History section of the Document). You may use the same title as a previous version if the original publisher of that version gives permission.
- B. List on the Title Page, as authors, one or more persons or entities responsible for authorship of the modifications in the Modified Version, together with at least five of the principal authors of the Document (all of its principal authors, if it has less than five).
- C. State on the Title page the name of the publisher of the Modified Version, as the publisher.
- D. Preserve all the copyright notices of the Document.
- E. Add an appropriate copyright notice for your modifications adjacent to the other copyright notices.
- F. Include, immediately after the copyright notices, a license notice giving the public permission to use the Modified Version under the terms of this License, in the form shown in the Addendum below.
- G. Preserve in that license notice the full lists of Invariant Sections and required Cover Texts given in the Document's license notice.
- H. Include an unaltered copy of this License.
 - I. Preserve the section entitled "History", and its title, and add to it an item stating at least the title, year, new authors, and publisher of the Modified Version as given on the Title Page. If there is no section entitled "History" in the Document, create one stating the title, year, authors, and publisher of the Document as given on its Title Page, then add an item describing the Modified Version as stated in the previous sentence.
 - J. Preserve the network location, if any, given in the Document for public access to a Transparent copy of the Document, and likewise the network locations given in the Document for previous versions it was based on. These may be placed in the "History" section. You may omit a network location for a work that was published at least four years before the Document itself, or if the original publisher of the version it refers to gives permission.
- K. In any section entitled "Acknowledgements" or "Dedications", preserve the section's title, and preserve in the section all the substance and tone of each of the contributor acknowledgements and/or dedications given therein.
- L. Preserve all the Invariant Sections of the Document, unaltered in their text and in their titles. Section numbers or the equivalent are not considered part of the section titles.
- M. Delete any section entitled "Endorsements". Such a section may not be included in the Modified Version.
- N. Do not retitle any existing section as "Endorsements" or to conflict in title with any Invariant Section.

If the Modified Version includes new front-matter sections or appendices that qualify as Secondary Sections and contain no material copied from the Document, you may at your option designate some or all of these

sections as invariant. To do this, add their titles to the list of Invariant Sections in the Modified Version's license notice. These titles must be distinct from any other section titles.

You may add a section entitled "Endorsements", provided it contains nothing but endorsements of your Modified Version by various parties—for example, statements of peer review or that the text has been approved by an organization as the authoritative definition of a standard.

You may add a passage of up to five words as a Front-Cover Text, and a passage of up to 25 words as a Back-Cover Text, to the end of the list of Cover Texts in the Modified Version. Only one passage of Front-Cover Text and one of Back-Cover Text may be added by (or through arrangements made by) any one entity. If the Document already includes a cover text for the same cover, previously added by you or by arrangement made by the same entity you are acting on behalf of, you may not add another; but you may replace the old one, on explicit permission from the previous publisher that added the old one.

The author(s) and publisher(s) of the Document do not by this License give permission to use their names for publicity for or to assert or imply endorsement of any Modified Version.

D.6. Combining documents

You may combine the Document with other documents released under this License, under the terms defined in section 4 above for modified versions, provided that you include in the combination all of the Invariant Sections of all of the original documents, unmodified, and list them all as Invariant Sections of your combined work in its license notice.

The combined work need only contain one copy of this License, and multiple identical Invariant Sections may be replaced with a single copy. If there are multiple Invariant Sections with the same name but different contents, make the title of each such section unique by adding at the end of it, in parentheses, the name of the original author or publisher of that section if known, or else a unique number. Make the same adjustment to the section titles in the list of Invariant Sections in the license notice of the combined work.

In the combination, you must combine any sections entitled "History" in the various original documents, forming one section entitled "History"; likewise combine any sections entitled "Acknowledgements", and any sections entitled "Dedications". You must delete all sections entitled "Endorsements."

D.7. Collections of documents

You may make a collection consisting of the Document and other documents released under this License, and replace the individual copies of this License in the various documents with a single copy that is included in the collection, provided that you follow the rules of this License for verbatim copying of each of the documents in all other respects.

You may extract a single document from such a collection, and distribute it individually under this License, provided you insert a copy of this License into the extracted document, and follow this License in all other respects regarding verbatim copying of that document.

D.8. Aggregation with independent works

A compilation of the Document or its derivatives with other separate and independent documents or works, in or on a volume of a storage or distribution medium, does not as a whole count as a Modified Version of the Document, provided no compilation copyright is claimed for the compilation. Such a compilation is called an "aggregate", and this License does not apply to the other self-contained works thus compiled with the Document, on account of their being thus compiled, if they are not themselves derivative works of the Document.

If the Cover Text requirement of section 3 is applicable to these copies of the Document, then if the Document is less than one quarter of the entire aggregate, the Document's Cover Texts may be placed on covers that surround only the Document within the aggregate. Otherwise they must appear on covers around the whole aggregate.

D.9. Translation

Translation is considered a kind of modification, so you may distribute translations of the Document under the terms of section 4. Replacing Invariant Sections with translations requires special permission from their copyright holders, but you may include translations of some or all Invariant Sections in addition to the original versions of these Invariant Sections. You may include a translation of this License provided that you also include the original English version of this License. In case of a disagreement between the translation and the original English version of this License, the original English version will prevail.

D.10. Termination

You may not copy, modify, sublicense, or distribute the Document except as expressly provided for under this License. Any other attempt to copy, modify, sublicense or distribute the Document is void, and will automatically terminate your rights under this License. However, parties who have received copies, or rights, from you under this License will not have their licenses terminated so long as such parties remain in full compliance.

D.11. Future revisions of this license

The Free Software Foundation may publish new, revised versions of the GNU Free Documentation License from time to time. Such new versions will be similar in spirit to the present version, but may differ in detail to address new problems or concerns. See <http://www.gnu.org/copyleft/>.

Each version of the License is given a distinguishing version number. If the Document specifies that a particular numbered version of this License "or any later version" applies to it, you have the option of following the terms and conditions either of that specified version or of any later version that has been published (not as a draft) by the Free Software Foundation. If the Document does not specify a version number of this License, you may choose any version ever published (not as a draft) by the Free Software Foundation.

D.12. How to use this License for your documents

To use this License in a document you have written, include a copy of the License in the document and put the following copyright and license notices just after the title page:

Copyright (c) YEAR YOUR NAME. Permission is granted to copy, distribute and/or modify this document under the terms of the GNU Free Documentation License, Version 1.1 or any later version published by the Free Software Foundation; with the Invariant Sections being LIST THEIR TITLES, with the Front-Cover Texts being LIST, and with the Back-Cover Texts being LIST. A copy of the license is included in the section entitled "GNU Free Documentation License".

If you have no Invariant Sections, write "with no Invariant Sections" instead of saying which ones are invariant. If you have no Front-Cover Texts, write "no Front-Cover Texts" instead of "Front-Cover Texts being LIST"; likewise for Back-Cover Texts.

If your document contains nontrivial examples of program code, we recommend releasing these examples in parallel under your choice of free software license, such as the GNU General Public License, to permit their use in free software.

Appendix E. proc.txt

This appendix holds the file `proc.txt`, which explains the `proc` file system on Linux machines.

E.1. The `/proc` Filesystem

This appendix contains a file from the documentation that comes with your Linux system, the `proc.txt` file. It explains in detail the contents of the `/proc` directory on your system. You'll find this directory very helpful for gathering system information.

```
-----
                          T H E   /p r o c   F I L E S Y S T E M
-----
/proc/sys      Terrehon Bowden <terrehon@pacbell.net>      October 7 1999
                Bodo Bauer <bb@ricochet.net>
2.4.x update   Jorge Nerin <comandante@zaralinux.com>      November 14 2000
-----
Version 1.3                                Kernel version 2.2.12
                                           Kernel version 2.4.0-test11-pre4
-----

Table of Contents
-----

0      Preface
0.1    Introduction/Credits
0.2    Legal Stuff

1      Collecting System Information
1.1    Process-Specific Subdirectories
1.2    Kernel data
1.3    IDE devices in /proc/ide
1.4    Networking info in /proc/net
1.5    SCSI info
1.6    Parallel port info in /proc/parport
1.7    TTY info in /proc/tty

2      Modifying System Parameters
2.1    /proc/sys/fs - File system data
2.2    /proc/sys/fs/binfmt_misc - Miscellaneous binary formats
2.3    /proc/sys/kernel - general kernel parameters
2.4    /proc/sys/vm - The virtual memory subsystem
2.5    /proc/sys/dev - Device specific parameters
2.6    /proc/sys/sunrpc - Remote procedure calls
2.7    /proc/sys/net - Networking stuff
2.8    /proc/sys/net/ipv4 - IPV4 settings
2.9    Appletalk
2.10   IPX

-----
Preface
-----

0.1 Introduction/Credits
```

Introduction to Linux

This documentation is part of a soon (or so we hope) to be released book on the SuSE Linux distribution. As there is no complete documentation for the /proc file system and we've used many freely available sources to write these chapters, it seems only fair to give the work back to the Linux community. This work is based on the 2.2.* kernel version and the upcoming 2.4.*. I'm afraid it's still far from complete, but we hope it will be useful. As far as we know, it is the first 'all-in-one' document about the /proc file system. It is focused on the Intel x86 hardware, so if you are looking for PPC, ARM, SPARC, APX, etc., features, you probably won't find what you are looking for. It also only covers IPv4 networking, not IPv6 nor other protocols - sorry. But additions and patches are welcome and will be added to this document if you mail them to Bodo.

We'd like to thank Alan Cox, Rik van Riel, and Alexey Kuznetsov and a lot of other people for help compiling this documentation. We'd also like to extend a special thank you to Andi Kleen for documentation, which we relied on heavily to create this document, as well as the additional information he provided. Thanks to everybody else who contributed source or docs to the Linux kernel and helped create a great piece of software... :)

If you have any comments, corrections or additions, please don't hesitate to contact Bodo Bauer at bb@ricochet.net. We'll be happy to add them to this document.

The latest version of this document is available online at <http://skaro.nightcrawler.com/~bb/Docs/Proc> as HTML version.

If the above direction does not works for you, ypu could try the kernel mailing list at linux-kernel@vger.kernel.org and/or try to reach me at comandante@zaralinux.com.

0.2 Legal Stuff

We don't guarantee the correctness of this document, and if you come to us complaining about how you screwed up your system because of incorrect documentation, we won't feel responsible...

CHAPTER 1: COLLECTING SYSTEM INFORMATION

In This Chapter

- * Investigating the properties of the pseudo file system /proc and its ability to provide information on the running Linux system
 - * Examining /proc's structure
 - * Uncovering various information about the kernel and the processes running on the system
-

The proc file system acts as an interface to internal data structures in the kernel. It can be used to obtain information about the system and to change certain kernel parameters at runtime (sysctl).

First, we'll take a look at the read-only parts of /proc. In Chapter 2, we show you how you can use /proc/sys to change settings.

Introduction to Linux

1.1 Process-Specific Subdirectories

The directory `/proc` contains (among other things) one subdirectory for each process running on the system, which is named after the process ID (PID).

The link `self` points to the process reading the file system. Each process subdirectory has the entries listed in Table 1-1.

Table 1-1: Process specific entries in `/proc`

File	Content
<code>cmdline</code>	Command line arguments
<code>cpu</code>	Current and last cpu in which it was executed (2.4)(smp)
<code>cwd</code>	Link to the current working directory
<code>environ</code>	Values of environment variables
<code>exe</code>	Link to the executable of this process
<code>fd</code>	Directory, which contains all file descriptors
<code>maps</code>	Memory maps to executables and library files (2.4)
<code>mem</code>	Memory held by this process
<code>root</code>	Link to the root directory of this process
<code>stat</code>	Process status
<code>statm</code>	Process memory status information
<code>status</code>	Process status in human readable form

For example, to get the status information of a process, all you have to do is read the file `/proc/PID/status`:

```
>cat /proc/self/status
Name:   cat
State:  R (running)
Pid:    5452
PPid:   743
TracerPid: 0 (2.4)
Uid:    501    501    501    501
Gid:    100    100    100    100
Groups: 100 14 16
VmSize: 1112 kB
VmLck:  0 kB
VmRSS:  348 kB
VmData: 24 kB
VmStk:  12 kB
VmExe:  8 kB
VmLib: 1044 kB
SigPnd: 0000000000000000
SigBlk: 0000000000000000
SigIgn: 0000000000000000
SigCgt: 0000000000000000
CapInh: 00000000fffffeff
CapPrm: 0000000000000000
CapEff: 0000000000000000
```

This shows you nearly the same information you would get if you viewed it with the `ps` command. In fact, `ps` uses the `proc` file system to obtain its information. The `statm` file contains more detailed information about the process memory usage. Its seven fields are explained in Table 1-2.

Table 1-2: Contents of the `statm` files

```

.....
File      Content
size      total program size
resident  size of memory portions
shared    number of pages that are shared
trs       number of pages that are 'code'
drs       number of pages of data/stack
lrs       number of pages of library
dt        number of dirty pages
.....

```

1.2 Kernel data

Similar to the process entries, the kernel data files give information about the running kernel. The files used to obtain this information are contained in /proc and are listed in Table 1-3. Not all of these will be present in your system. It depends on the kernel configuration and the loaded modules, which files are there, and which are missing.

Table 1-3: Kernel info in /proc

```

.....
File      Content
apm       Advanced power management info
bus       Directory containing bus specific information
cmdline   Kernel command line
cpuinfo   Info about the CPU
devices   Available devices (block and character)
dma       Used DMS channels
filesystems Supported filesystems
driver    Various drivers grouped here, currently rtc      (2.4)
execdomains Execdomains, related to security                (2.4)
fb        Frame Buffer devices                             (2.4)
fs        File system parameters, currently nfs/exports    (2.4)
ide       Directory containing info about the IDE subsystem
interrupts Interrupt usage
iomem     Memory map                                        (2.4)
ioports   I/O port usage
irq       Masks for irq to cpu affinity                     (2.4)(smp?)
isapnp    ISA PnP (Plug&Play) Info                        (2.4)
kcore     Kernel core image (can be ELF or A.OUT(deprecated in 2.4))
kmsg      Kernel messages
ksyms     Kernel symbol table
loadavg   Load average of last 1, 5 & 15 minutes
locks    Kernel locks
meminfo   Memory info
misc      Miscellaneous
modules   List of loaded modules
mounts    Mounted filesystems
net       Networking info (see text)
partitions Table of partitions known to the system
pci       Depreciated info of PCI bus (new way -> /proc/bus/pci/,
          decoupled by lspci                       (2.4)
rtc       Real time clock
scsi      SCSI info (see text)
slabinfo  Slab pool info
stat      Overall statistics
swaps     Swap space utilization
sys       See chapter 2
sysvipc   Info of SysVIPC Resources (msg, sem, shm)        (2.4)
tty       Info of tty drivers
uptime   System uptime
.....

```

Introduction to Linux

```
version      Kernel version
video       bttv info of video resources          (2.4)
.....
```

You can, for example, check which interrupts are currently in use and what they are used for by looking in the file `/proc/interrupts`:

```
> cat /proc/interrupts
      CPU0
0:    8728810          XT-PIC  timer
1:      895          XT-PIC  keyboard
2:      0          XT-PIC  cascade
3:    531695          XT-PIC  aha152x
4:   2014133          XT-PIC  serial
5:    44401          XT-PIC  pcnet_cs
8:      2          XT-PIC  rtc
11:     8          XT-PIC  i82365
12:   182918          XT-PIC  PS/2 Mouse
13:     1          XT-PIC  fpu
14:  1232265          XT-PIC  ide0
15:     7          XT-PIC  ide1
NMI:     0
```

In 2.4.* a couple of lines were added to this file LOC & ERR (this time is the output of a SMP machine):

```
> cat /proc/interrupts

      CPU0      CPU1
0:    1243498   1214548  IO-APIC-edge  timer
1:      8949    8958    IO-APIC-edge  keyboard
2:      0      0        XT-PIC  cascade
5:    11286    10161  IO-APIC-edge  soundblaster
8:      1      0        IO-APIC-edge  rtc
9:    27422    27407  IO-APIC-edge  3c503
12:   113645   113873  IO-APIC-edge  PS/2 Mouse
13:     0      0        XT-PIC  fpu
14:    22491    24012  IO-APIC-edge  ide0
15:     2183    2415    IO-APIC-edge  ide1
17:    30564    30414  IO-APIC-level  eth0
18:     177     164    IO-APIC-level  bttv
NMI:  2457961   2457959
LOC:  2457882   2457881
ERR:    2155
```

NMI is incremented in this case because every timer interrupt generates a NMI (Non Maskable Interrupt) which is used by the NMI Watchdog to detect lookups.

LOC is the local interrupt counter of the internal APIC of every CPU.

ERR is incremented in the case of errors in the IO-APIC bus (the bus that connects the CPUs in a SMP system. This means that an error has been detected, the IO-APIC automatically retry the transmission, so it should not be a big problem, but you should read the SMP-FAQ.

In this context it could be interesting to note the new `irq` directory in 2.4. It could be used to set IRQ to CPU affinity, this means that you can "hook" an IRQ to only one CPU, or to exclude a CPU of handling IRQs. The contents of the `irq` subdir is one subdir for each IRQ, and one file; `prof_cpu_mask`

For example

```
> ls /proc/irq/
```

Introduction to Linux

```
0 10 12 14 16 18 2 4 6 8 prof_cpu_mask
1 11 13 15 17 19 3 5 7 9
> ls /proc/irq/0/
smp_affinity
```

The contents of the `prof_cpu_mask` file and each `smp_affinity` file for each IRQ is the same by default:

```
> cat /proc/irq/0/smp_affinity
ffffffff
```

It's a bitmask, in which you can specify which CPUs can handle the IRQ, you can set it by doing:

```
> echo 1 > /proc/irq/0/smp_affinity
```

This means that only the first CPU will handle the IRQ, but you can also echo 5 which means that only the first and fourth CPU can handle the IRQ.

The way IRQs are routed is handled by the IO-APIC, and it's Round Robin between all the CPUs which are allowed to handle it. As usual the kernel has more info than you and does a better job than you, so the defaults are the best choice for almost everyone.

There are three more important subdirectories in `/proc`: `net`, `scsi`, and `sys`. The general rule is that the contents, or even the existence of these directories, depend on your kernel configuration. If SCSI is not enabled, the directory `scsi` may not exist. The same is true with the `net`, which is there only when networking support is present in the running kernel.

The `slabinfo` file gives information about memory usage at the slab level. Linux uses slab pools for memory management above page level in version 2.2. Commonly used objects have their own slab pool (such as network buffers, directory cache, and so on).

1.3 IDE devices in `/proc/ide`

The subdirectory `/proc/ide` contains information about all IDE devices of which the kernel is aware. There is one subdirectory for each IDE controller, the file `drivers` and a link for each IDE device, pointing to the device directory in the controller specific subtree.

The file `drivers` contains general information about the drivers used for the IDE devices:

```
> cat /proc/ide/drivers
ide-cdrom version 4.53
ide-disk version 1.08
```

More detailed information can be found in the controller specific subdirectories. These are named `ide0`, `ide1` and so on. Each of these directories contains the files shown in table 1-4.

Table 1-4: IDE controller info in `/proc/ide/ide?`

```
.....
File      Content
channel  IDE channel (0 or 1)
config    Configuration (only for PCI/IDE bridge)
mate      Mate name
```

```
model    Type/Chipset of IDE controller
.....
```

Each device connected to a controller has a separate subdirectory in the controllers directory. The files listed in table 1-5 are contained in these directories.

Table 1-5: IDE device information

```
.....
File      Content
cache     The cache
capacity  Capacity of the medium (in 512Byte blocks)
driver    driver and version
geometry  physical and logical geometry
identify  device identify block
media     media type
model     device identifier
settings  device setup
smart_thresholds IDE disk management thresholds
smart_values IDE disk management values
.....
```

The most interesting file is settings. This file contains a nice overview of the drive parameters:

```
# cat /proc/ide/ide0/hda/settings
name      value      min      max      mode
----      -
bios_cyl  526        0        65535    rw
bios_head 255        0        255      rw
bios_sect 63         0        63       rw
breada_readahead 4         0        127      rw
bswap     0          0        1        r
file_readahead 72       0        2097151  rw
io_32bit  0          0        3        rw
keepsettings 0        0        1        rw
max_kb_per_request 122     1        127      rw
multcount 0          0        8        rw
nicel     1          0        1        rw
nowerr    0          0        1        rw
pio_mode  write-only 0        255      w
slow     0          0        1        rw
unmaskirq 0          0        1        rw
using_dma 0          0        1        rw
```

1.4 Networking info in /proc/net

The subdirectory /proc/net follows the usual pattern. Table 1-6 shows the additional values you get for IP version 6 if you configure the kernel to support this. Table 1-7 lists the files and their meaning.

Table 1-6: IPv6 info in /proc/net

```
.....
File      Content
udp6     UDP sockets (IPv6)
tcp6     TCP sockets (IPv6)
raw6     Raw device statistics (IPv6)
igmp6    IP multicast addresses, which this host joined (IPv6)
.....
```

Introduction to Linux

```
if_inet6  List of IPv6 interface addresses
ipv6_route Kernel routing table for IPv6
rt6_stats Global IPv6 routing tables statistics
sockstat6 Socket statistics (IPv6)
snmp6     Snmp data (IPv6)
.....
```

Table 1-7: Network info in /proc/net

```
.....
File          Content
arp           Kernel ARP table
dev           network devices with statistics
dev_mcast    the Layer2 multicast groups a device is listening too
              (interface index, label, number of references, number of bound
              addresses).
dev_stat     network device status
ip_fwchains  Firewall chain linkage
ip_fwnames   Firewall chain names
ip_masq     Directory containing the masquerading tables
ip_masquerade Major masquerading table
netstat     Network statistics
raw         raw device statistics
route       Kernel routing table
rpc         Directory containing rpc info
rt_cache    Routing cache
snmp        SNMP data
sockstat    Socket statistics
tcp         TCP sockets
tr_rif      Token ring RIF routing table
udp         UDP sockets
unix        UNIX domain sockets
wireless    Wireless interface data (Wavelan etc)
igmp        IP multicast addresses, which this host joined
psched      Global packet scheduler parameters.
netlink     List of PF_NETLINK sockets
ip_mr_vifs  List of multicast virtual interfaces
ip_mr_cache List of multicast routing cache
.....
```

You can use this information to see which network devices are available in your system and how much traffic was routed over those devices:

```
> cat /proc/net/dev
Inter-|Receive
face |bytes  packets errs drop fifo frame compressed multicast|[...]
  lo: 908188  5596    0   0   0   0   0   0   0 [...]
 ppp0:15475140 20721  410   0   0   0 410   0   0 [...]
 eth0: 614530  7085    0   0   0   0   0   0   1 [...

... ] Transmit
... ] bytes  packets errs drop fifo colls carrier compressed
... ] 908188  5596    0   0   0   0   0   0
... ] 1375103 17405    0   0   0   0   0   0
... ] 1703981 5535    0   0   0   3   0   0
```

In addition, each Channel Bond interface has its own directory. For example, the bond0 device will have a directory called /proc/net/bond0/. It will contain information that is specific to that bond, such as the current slaves of the bond, the link status of the slaves, and how many times the slaves link has failed.

Introduction to Linux

1.5 SCSI info

If you have a SCSI host adapter in your system, you'll find a subdirectory named after the driver for this adapter in `/proc/scsi`. You'll also see a list of all recognized SCSI devices in `/proc/scsi`:

```
>cat /proc/scsi/scsi
Attached devices:
Host: scsi0 Channel: 00 Id: 00 Lun: 00
  Vendor: IBM      Model: DGHS09U      Rev: 03E0
  Type:   Direct-Access      ANSI SCSI revision: 03
Host: scsi0 Channel: 00 Id: 06 Lun: 00
  Vendor: PIONEER Model: CD-ROM DR-U06S Rev: 1.04
  Type:   CD-ROM            ANSI SCSI revision: 02
```

The directory named after the driver has one file for each adapter found in the system. These files contain information about the controller, including the used IRQ and the IO address range. The amount of information shown is dependent on the adapter you use. The example shows the output for an Adaptec AHA-2940 SCSI adapter:

```
> cat /proc/scsi/aic7xxx/0

Adaptec AIC7xxx driver version: 5.1.19/3.2.4
Compile Options:
  TCQ Enabled By Default : Disabled
  AIC7XXX_PROC_STATS     : Disabled
  AIC7XXX_RESET_DELAY    : 5
Adapter Configuration:
  SCSI Adapter: Adaptec AHA-294X Ultra SCSI host adapter
                Ultra Wide Controller
  PCI MMAPed I/O Base: 0xeb001000
  Adapter SEEPROM Config: SEEPROM found and used.
  Adaptec SCSI BIOS: Enabled
                    IRQ: 10
                    SCBs: Active 0, Max Active 2,
                          Allocated 15, HW 16, Page 255
  Interrupts: 160328
  BIOS Control Word: 0xl8b6
  Adapter Control Word: 0x005b
  Extended Translation: Enabled
  Disconnect Enable Flags: 0xffff
  Ultra Enable Flags: 0x0001
  Tag Queue Enable Flags: 0x0000
  Ordered Queue Tag Flags: 0x0000
  Default Tag Queue Depth: 8
  Tagged Queue By Device array for aic7xxx host instance 0:
    {255,255,255,255,255,255,255,255,255,255,255,255,255,255,255}
  Actual queue depth per device for aic7xxx host instance 0:
    {1,1,1,1,1,1,1,1,1,1,1,1,1,1,1}
Statistics:
(scsi0:0:0:0)
  Device using Wide/Sync transfers at 40.0 MByte/sec, offset 8
  Transinfo settings: current(12/8/1/0), goal(12/8/1/0), user(12/15/1/0)
  Total transfers 160151 (74577 reads and 85574 writes)
(scsi0:0:6:0)
  Device using Narrow/Sync transfers at 5.0 MByte/sec, offset 15
  Transinfo settings: current(50/15/0/0), goal(50/15/0/0), user(50/15/0/0)
  Total transfers 0 (0 reads and 0 writes)
```

Introduction to Linux

1.6 Parallel port info in /proc/parport

The directory `/proc/parport` contains information about the parallel ports of your system. It has one subdirectory for each port, named after the port number (0,1,2,...).

These directories contain the four files shown in Table 1-8.

Table 1-8: Files in /proc/parport

File	Content
<code>autoprobe</code>	Any IEEE-1284 device ID information that has been acquired.
<code>devices</code>	list of the device drivers using that port. A + will appear by the name of the device currently using the port (it might not appear against any).
<code>hardware</code>	Parallel port's base address, IRQ line and DMA channel.
<code>irq</code>	IRQ that parport is using for that port. This is in a separate file to allow you to alter it by writing a new value in (IRQ number or none).

1.7 TTY info in /proc/tty

Information about the available and actually used tty's can be found in the directory `/proc/tty`. You'll find entries for drivers and line disciplines in this directory, as shown in Table 1-9.

Table 1-9: Files in /proc/tty

File	Content
<code>drivers</code>	list of drivers and their usage
<code>ldiscs</code>	registered line disciplines
<code>driver/serial</code>	usage statistic and status of single tty lines

To see which tty's are currently in use, you can simply look into the file `/proc/tty/drivers`:

```
> cat /proc/tty/drivers
pty_slave      /dev/pts      136  0-255 pty:slave
pty_master     /dev/ptm      128  0-255 pty:master
pty_slave      /dev/ttyp     3    0-255 pty:slave
pty_master     /dev/pty      2    0-255 pty:master
serial         /dev/cua      5    64-67 serial:callout
serial         /dev/ttyS     4    64-67 serial
/dev/tty0      /dev/tty0     4    0    system:vtmaster
/dev/ptmx      /dev/ptmx     5    2    system
/dev/console   /dev/console  5    1    system:console
/dev/tty       /dev/tty      5    0    system:/dev/tty
unknown        /dev/tty      4    1-63 console
```

Summary

The `/proc` file system serves information about the running system. It not only allows access to process data but also allows you to request the kernel status

by reading files in the hierarchy.

The directory structure of /proc reflects the types of information and makes it easy, if not obvious, where to look for specific data.

CHAPTER 2: MODIFYING SYSTEM PARAMETERS

In This Chapter

- * Modifying kernel parameters by writing into files found in /proc/sys
 - * Exploring the files which modify certain parameters
 - * Review of the /proc/sys file tree
-

A very interesting part of /proc is the directory /proc/sys. This is not only a source of information, it also allows you to change parameters within the kernel. Be very careful when attempting this. You can optimize your system, but you can also cause it to crash. Never alter kernel parameters on a production system. Set up a development machine and test to make sure that everything works the way you want it to. You may have no alternative but to reboot the machine once an error has been made.

To change a value, simply echo the new value into the file. An example is given below in the section on the file system data. You need to be root to do this. You can create your own boot script to perform this every time your system boots.

The files in /proc/sys can be used to fine tune and monitor miscellaneous and general things in the operation of the Linux kernel. Since some of the files can inadvertently disrupt your system, it is advisable to read both documentation and source before actually making adjustments. In any case, be very careful when writing to any of these files. The entries in /proc may change slightly between the 2.1.* and the 2.2 kernel, so if there is any doubt review the kernel documentation in the directory /usr/src/linux/Documentation. This chapter is heavily based on the documentation included in the pre 2.2 kernels, and became part of it in version 2.2.1 of the Linux kernel.

2.1 /proc/sys/fs - File system data

This subdirectory contains specific file system, file handle, inode, dentry and quota information.

Currently, these files are in /proc/sys/fs:

dentry-state

Status of the directory cache. Since directory entries are dynamically allocated and deallocated, this file indicates the current status. It holds six values, in which the last two are not used and are always zero. The others are listed in table 2-1.

Table 2-1: Status files of the directory cache

File	Content
------	---------

Introduction to Linux

```
nr_dentry  Almost always zero
nr_unused  Number of unused cache entries
age_limit  in seconds after the entry may be reclaimed, when memory is short
want_pages internally
.....
```

dquot-nr and dquot-max -----

The file `dquot-max` shows the maximum number of cached disk quota entries.

The file `dquot-nr` shows the number of allocated disk quota entries and the number of free disk quota entries.

If the number of available cached disk quotas is very low and you have a large number of simultaneous system users, you might want to raise the limit.

file-nr and file-max -----

The kernel allocates file handles dynamically, but doesn't free them again at this time.

The value in `file-max` denotes the maximum number of file handles that the Linux kernel will allocate. When you get a lot of error messages about running out of file handles, you might want to raise this limit. The default value is 4096. To change it, just write the new number into the file:

```
# cat /proc/sys/fs/file-max
4096
# echo 8192 > /proc/sys/fs/file-max
# cat /proc/sys/fs/file-max
8192
```

This method of revision is useful for all customizable parameters of the kernel - simply echo the new value to the corresponding file.

The three values in `file-nr` denote the number of allocated file handles, the number of used file handles, and the maximum number of file handles. When the allocated file handles come close to the maximum, but the number of actually used ones is far behind, you've encountered a peak in your usage of file handles and you don't need to increase the maximum.

inode-state and inode-nr -----

The file `inode-nr` contains the first two items from `inode-state`, so we'll skip to that file...

`inode-state` contains two actual numbers and five dummy values. The numbers are `nr_inodes` and `nr_free_inodes` (in order of appearance).

```
nr_inodes
~~~~~
```

Denotes the number of inodes the system has allocated. This number will grow and shrink dynamically.

```
nr_free_inodes
-----
```

Represents the number of free inodes. Ie. The number of inuse inodes is (nr_inodes - nr_free_inodes).

super-nr and super-max

Again, super block structures are allocated by the kernel, but not freed. The file super-max contains the maximum number of super block handlers, where super-nr shows the number of currently allocated ones.

Every mounted file system needs a super block, so if you plan to mount lots of file systems, you may want to increase these numbers.

2.2 /proc/sys/fs/binfmt_misc - Miscellaneous binary formats -----

Besides these files, there is the subdirectory /proc/sys/fs/binfmt_misc. This handles the kernel support for miscellaneous binary formats.

Binfmt_misc provides the ability to register additional binary formats to the Kernel without compiling an additional module/kernel. Therefore, binfmt_misc needs to know magic numbers at the beginning or the filename extension of the binary.

It works by maintaining a linked list of structs that contain a description of a binary format, including a magic with size (or the filename extension), offset and mask, and the interpreter name. On request it invokes the given interpreter with the original program as argument, as binfmt_java and binfmt_em86 and binfmt_mz do. Since binfmt_misc does not define any default binary-formats, you have to register an additional binary-format.

There are two general files in binfmt_misc and one file per registered format. The two general files are register and status.

Registering a new binary format

To register a new binary format you have to issue the command

```
echo :name:type:offset:magic:mask:interpreter: > /proc/sys/fs/binfmt_misc/register
```

with appropriate name (the name for the /proc-dir entry), offset (defaults to 0, if omitted), magic, mask (which can be omitted, defaults to all 0xff) and last but not least, the interpreter that is to be invoked (for example and testing /bin/echo). Type can be M for usual magic matching or E for filename extension matching (give extension in place of magic).

Check or reset the status of the binary format handler

If you do a cat on the file /proc/sys/fs/binfmt_misc/status, you will get the current status (enabled/disabled) of binfmt_misc. Change the status by echoing 0 (disables) or 1 (enables) or -1 (caution: this clears all previously registered binary formats) to status. For example echo 0 > status to disable binfmt_misc (temporarily).

Status of a single handler

Introduction to Linux

Each registered handler has an entry in `/proc/sys/fs/binfmt_misc`. These files perform the same function as `status`, but their scope is limited to the actual binary format. By cating this file, you also receive all related information about the interpreter/magic of the `binfmt`.

Example usage of `binfmt_misc` (emulate `binfmt_java`)

```
-----  
  
cd /proc/sys/fs/binfmt_misc  
echo ':Java:M::\xca\xfe\xba\xbe::/usr/local/java/bin/javawrapper:' > register  
echo ':HTML:E::html::/usr/local/java/bin/appletviewer:' > register  
echo ':Applet:M::<applet::/usr/local/java/bin/appletviewer:' > register  
echo ':DEXE:M::\x0eDEX::/usr/bin/dosexec:' > register
```

These four lines add support for Java executables and Java applets (like `binfmt_java`, additionally recognizing the `.html` extension with no need to put `<!--applet>` to every applet file). You have to install the JDK and the shell-script `/usr/local/java/bin/javawrapper` too. It works around the brokenness of the Java filename handling. To add a Java binary, just create a link to the class-file somewhere in the path.

2.3 `/proc/sys/kernel` - general kernel parameters

This directory reflects general kernel behaviors. As I've said before, the contents depend on your configuration. Here you'll find the most important files, along with descriptions of what they mean and how to use them.

`acct`

The file contains three values; `highwater`, `lowwater`, and `frequency`.

It exists only when BSD-style process accounting is enabled. These values control its behavior. If the free space on the file system where the log lives goes below `lowwater` percentage, accounting suspends. If it goes above `highwater` percentage, accounting resumes. `Frequency` determines how often you check the amount of free space (value is in seconds). Default settings are: 4, 2, and 30. That is, suspend accounting if there is less than 2 percent free; resume it if we have a value of 3 or more percent; consider information about the amount of free space valid for 30 seconds

`ctrl-alt-del`

When the value in this file is 0, `ctrl-alt-del` is trapped and sent to the `init` program to handle a graceful restart. However, when the value is greater than zero, Linux's reaction to this key combination will be an immediate reboot, without syncing its dirty buffers.

[NOTE]

When a program (like `dosemu`) has the keyboard in raw mode, the `ctrl-alt-del` is intercepted by the program before it ever reaches the kernel tty layer, and it is up to the program to decide what to do with it.

`domainname` and `hostname`

These files can be controlled to set the NIS `domainname` and `hostname` of your box. For the classic `darkstar.frop.org` a simple:

Introduction to Linux

```
# echo "darkstar" > /proc/sys/kernel/hostname
# echo "frop.org" > /proc/sys/kernel/domainname
```

would suffice to set your hostname and NIS domainname.

osrelease, ostype and version

The names make it pretty obvious what these fields contain:

```
> cat /proc/sys/kernel/osrelease
2.2.12
```

```
> cat /proc/sys/kernel/ostype
Linux
```

```
> cat /proc/sys/kernel/version
#4 Fri Oct 1 12:41:14 PDT 1999
```

The files `osrelease` and `ostype` should be clear enough. Version needs a little more clarification. The `#4` means that this is the 4th kernel built from this source base and the date after it indicates the time the kernel was built. The only way to tune these values is to rebuild the kernel.

panic

The value in this file represents the number of seconds the kernel waits before rebooting on a panic. When you use the software watchdog, the recommended setting is 60. If set to 0, the auto reboot after a kernel panic is disabled, which is the default setting.

printk

The four values in `printk` denote

- * `console_loglevel`,
- * `default_message_loglevel`,
- * `minimum_console_level` and
- * `default_console_loglevel`

respectively.

These values influence `printk()` behavior when printing or logging error messages, which come from inside the kernel. See `syslog(2)` for more information on the different log levels.

`console_loglevel`

Messages with a higher priority than this will be printed to the console.

`default_message_level`

Messages without an explicit priority will be printed with this priority.

`minimum_console_loglevel`

Introduction to Linux

Minimum (highest) value to which the console_loglevel can be set.

default_console_loglevel

Default value for console_loglevel.

sg-big-buff

This file shows the size of the generic SCSI (sg) buffer. At this point, you can't tune it yet, but you can change it at compile time by editing include/scsi/sg.h and changing the value of SG_BIG_BUFF.

If you use a scanner with SANE (Scanner Access Now Easy) you might want to set this to a higher value. Refer to the SANE documentation on this issue.

modprobe

The location where the modprobe binary is located. The kernel uses this program to load modules on demand.

2.4 /proc/sys/vm - The virtual memory subsystem -----

The files in this directory can be used to tune the operation of the virtual memory (VM) subsystem of the Linux kernel. In addition, one of the files (bdflush) has some influence on disk usage.

bdflush

This file controls the operation of the bdflush kernel daemon. It currently contains nine integer values, six of which are actually used by the kernel. They are listed in table 2-2.

Table 2-2: Parameters in /proc/sys/vm/bdflush

Value	Meaning
nfract	Percentage of buffer cache dirty to activate bdflush
ndirty	Maximum number of dirty blocks to write out per wake-cycle
nrefill	Number of clean buffers to try to obtain each time we call refill
nref_dirt	buffer threshold for activating bdflush when trying to refill buffers.
dummy	Unused
age_buffer	Time for normal buffer to age before we flush it
age_super	Time for superblock to age before we flush it
dummy	Unused
dummy	Unused

nfract

This parameter governs the maximum number of dirty buffers in the buffer cache. Dirty means that the contents of the buffer still have to be written to disk (as opposed to a clean buffer, which can just be forgotten about). Setting this to a higher value means that Linux can delay disk writes for a long time, but it also means that it will have to do a lot of I/O at once when memory becomes short. A lower value will spread out disk I/O more evenly.

Introduction to Linux

ndirty

Ndirty gives the maximum number of dirty buffers that bdflush can write to the disk at one time. A high value will mean delayed, bursty I/O, while a small value can lead to memory shortage when bdflush isn't woken up often enough.

nrefill

This is the number of buffers that bdflush will add to the list of free buffers when refill_freelist() is called. It is necessary to allocate free buffers beforehand, since the buffers are often different sizes than the memory pages and some bookkeeping needs to be done beforehand. The higher the number, the more memory will be wasted and the less often refill_freelist() will need to run.

nref_dirt

When refill_freelist() comes across more than nref_dirt dirty buffers, it will wake up bdflush.

age_buffer and age_super

Finally, the age_buffer and age_super parameters govern the maximum time Linux waits before writing out a dirty buffer to disk. The value is expressed in jiffies (clockticks), the number of jiffies per second is 100. Age_buffer is the maximum age for data blocks, while age_super is for filesystems meta data.

buffermem

The three values in this file control how much memory should be used for buffer memory. The percentage is calculated as a percentage of total system memory.

The values are:

min_percent

This is the minimum percentage of memory that should be spent on buffer memory.

borrow_percent

When Linux is short on memory, and the buffer cache uses more than it has been allotted, the memory management (MM) subsystem will prune the buffer cache more heavily than other memory to compensate.

max_percent

This is the maximum amount of memory that can be used for buffer memory.

freepages

Introduction to Linux

This file contains three values: min, low and high:

min

When the number of free pages in the system reaches this number, only the kernel can allocate more memory.

low

If the number of free pages falls below this point, the kernel starts swapping aggressively.

high

The kernel tries to keep up to this amount of memory free; if memory falls below this point, the kernel starts gently swapping in the hopes that it never has to do really aggressive swapping.

kswapd

Kswapd is the kernel swap out daemon. That is, kswapd is that piece of the kernel that frees memory when it gets fragmented or full. Since every system is different, you'll probably want some control over this piece of the system.

The file contains three numbers:

tries_base

The maximum number of pages kswapd tries to free in one round is calculated from this number. Usually this number will be divided by 4 or 8 (see mm/vmscan.c), so it isn't as big as it looks.

When you need to increase the bandwidth to/from swap, you'll want to increase this number.

tries_min

This is the minimum number of times kswapd tries to free a page each time it is called. Basically it's just there to make sure that kswapd frees some pages even when it's being called with minimum priority.

swap_cluster

This is probably the greatest influence on system performance.

swap_cluster is the number of pages kswapd writes in one turn. You'll want this value to be large so that kswapd does its I/O in large chunks and the disk doesn't have to seek as often, but you don't want it to be too large since that would flood the request queue.

overcommit_memory

This file contains one value. The following algorithm is used to decide if there's enough memory: if the value of overcommit_memory is positive, then there's always enough memory. This is a useful feature, since programs often malloc() huge amounts of memory 'just in case', while they only use a small part of it. Leaving this value at 0 will lead to the failure of such a huge

Introduction to Linux

malloc(), when in fact the system has enough memory for the program to run.

On the other hand, enabling this feature can cause you to run out of memory and thrash the system to death, so large and/or important servers will want to set this value to 0.

pagecache

This file does exactly the same job as buffermem, only this file controls the amount of memory allowed for memory mapping and generic caching of files.

You don't want the minimum level to be too low, otherwise your system might thrash when memory is tight or fragmentation is high.

pagetable_cache

The kernel keeps a number of page tables in a per-processor cache (this helps a lot on SMP systems). The cache size for each processor will be between the low and the high value.

On a low-memory, single CPU system, you can safely set these values to 0 so you don't waste memory. It is used on SMP systems so that the system can perform fast pagetable allocations without having to acquire the kernel memory lock.

For large systems, the settings are probably fine. For normal systems they won't hurt a bit. For small systems (less than 16MB ram) it might be advantageous to set both values to 0.

swapctl

This file contains no less than 8 variables. All of these values are used by kswapd.

The first four variables

- * sc_max_page_age,
- * sc_page_advance,
- * sc_page_decline and
- * sc_page_initial_age

are used to keep track of Linux's page aging. Page aging is a bookkeeping method to track which pages of memory are often used, and which pages can be swapped out without consequences.

When a page is swapped in, it starts at sc_page_initial_age (default 3) and when the page is scanned by kswapd, its age is adjusted according to the following scheme:

- * If the page was used since the last time we scanned, its age is increased by sc_page_advance (default 3). Where the maximum value is given by sc_max_page_age (default 20).
- * Otherwise (meaning it wasn't used) its age is decreased by sc_page_decline (default 1).

When a page reaches age 0, it's ready to be swapped out.

The variables sc_age_cluster_fract, sc_age_cluster_min, sc_pageout_weight and sc_bufferout_weight, can be used to control kswapd's aggressiveness in swapping out pages.

Introduction to Linux

`Sc_age_cluster_fract` is used to calculate how many pages from a process are to be scanned by `kswapd`. The formula used is

```
(sc_age_cluster_fract divided by 1024) times resident set size
```

So if you want `kswapd` to scan the whole process, `sc_age_cluster_fract` needs to have a value of 1024. The minimum number of pages `kswapd` will scan is represented by `sc_age_cluster_min`, which is done so that `kswapd` will also scan small processes.

The values of `sc_pageout_weight` and `sc_bufferout_weight` are used to control how many tries `kswapd` will make in order to swap out one page/buffer. These values can be used to fine-tune the ratio between user pages and buffer/cache memory. When you find that your Linux system is swapping out too many process pages in order to satisfy buffer memory demands, you may want to either increase `sc_bufferout_weight`, or decrease the value of `sc_pageout_weight`.

2.5 /proc/sys/dev - Device specific parameters

Currently there is only support for CDROM drives, and for those, there is only one read-only file containing information about the CD-ROM drives attached to the system:

```
>cat /proc/sys/dev/cdrom/info
CD-ROM information, Id: cdrom.c 2.55 1999/04/25

drive name:          sr0      hdb
drive speed:         32       40
drive # of slots:    1       0
Can close tray:      1       1
Can open tray:       1       1
Can lock tray:       1       1
Can change speed:    1       1
Can select disk:     0       1
Can read multisession: 1     1
Can read MCN:        1       1
Reports media changed: 1     1
Can play audio:      1       1
```

You see two drives, `sr0` and `hdb`, along with a list of their features.

2.6 /proc/sys/sunrpc - Remote procedure calls

This directory contains four files, which enable or disable debugging for the RPC functions NFS, NFS-daemon, RPC and NLM. The default values are 0. They can be set to one to turn debugging on. (The default value is 0 for each)

2.7 /proc/sys/net - Networking stuff

The interface to the networking parts of the kernel is located in `/proc/sys/net`. Table 2-3 shows all possible subdirectories. You may see only some of them, depending on your kernel's configuration.

Table 2-3: Subdirectories in `/proc/sys/net`

.....			
Directory	Content	Directory	Content
core	General parameter	appletalk	Appletalk protocol

Introduction to Linux

unix	Unix domain sockets	netrom	NET/ROM
802	E802 protocol	ax25	AX25
ethernet	Ethernet protocol	rose	X.25 PLP layer
ipv4	IP version 4	x25	X.25 protocol
ipx	IPX	token-ring	IBM token ring
bridge	Bridging	decnet	DEC net
ipv6	IP version 6		

.....

We will concentrate on IP networking here. Since AX15, X.25, and DEC Net are only minor players in the Linux world, we'll skip them in this chapter. You'll find some short info on Appletalk and IPX further on in this chapter. Review the online documentation and the kernel source to get a detailed view of the parameters for those protocols. In this section we'll discuss the subdirectories printed in bold letters in the table above. As default values are suitable for most needs, there is no need to change these values.

`/proc/sys/net/core` - Network core options

`rmem_default`

The default setting of the socket receive buffer in bytes.

`rmem_max`

The maximum receive socket buffer size in bytes.

`wmem_default`

The default setting (in bytes) of the socket send buffer.

`wmem_max`

The maximum send socket buffer size in bytes.

`message_burst` and `message_cost`

These parameters are used to limit the warning messages written to the kernel log from the networking code. They enforce a rate limit to make a denial-of-service attack impossible. A higher `message_cost` factor, results in fewer messages that will be written. `Message_burst` controls when messages will be dropped. The default settings limit warning messages to one every five seconds.

`netdev_max_backlog`

Maximum number of packets, queued on the INPUT side, when the interface receives packets faster than kernel can process them.

`optmem_max`

Maximum ancillary buffer size allowed per socket. Ancillary data is a sequence of struct `cmsghdr` structures with appended data.

Introduction to Linux

/proc/sys/net/unix - Parameters for Unix domain sockets

There are only two files in this subdirectory. They control the delays for deleting and destroying socket descriptors.

2.8 /proc/sys/net/ipv4 - IPV4 settings

IP version 4 is still the most used protocol in Unix networking. It will be replaced by IP version 6 in the next couple of years, but for the moment it's the de facto standard for the internet and is used in most networking environments around the world. Because of the importance of this protocol, we'll have a deeper look into the subtree controlling the behavior of the IPv4 subsystem of the Linux kernel.

Let's start with the entries in /proc/sys/net/ipv4.

ICMP settings

icmp_echo_ignore_all and icmp_echo_ignore_broadcasts

Turn on (1) or off (0), if the kernel should ignore all ICMP ECHO requests, or just those to broadcast and multicast addresses.

Please note that if you accept ICMP echo requests with a broadcast/multi\cast destination address your network may be used as an exploder for denial of service packet flooding attacks to other hosts.

icmp_destunreach_rate, icmp_echoreply_rate, icmp_paramprob_rate and icmp_timeexeed_rate

Sets limits for sending ICMP packets to specific targets. A value of zero disables all limiting. Any positive value sets the maximum package rate in hundredth of a second (on Intel systems).

IP settings

ip_autoconfig

This file contains the number one if the host received its IP configuration by RARP, BOOTP, DHCP or a similar mechanism. Otherwise it is zero.

ip_default_ttl

TTL (Time To Live) for IPv4 interfaces. This is simply the maximum number of hops a packet may travel.

ip_dynaddr

Enable dynamic socket address rewriting on interface address change. This is useful for dialup interface with changing IP addresses.

ip_forward

Introduction to Linux

Enable or disable forwarding of IP packages between interfaces. Changing this value resets all other parameters to their default values. They differ if the kernel is configured as host or router.

ip_local_port_range

Range of ports used by TCP and UDP to choose the local port. Contains two numbers, the first number is the lowest port, the second number the highest local port. Default is 1024-4999. Should be changed to 32768-61000 for high-usage systems.

ip_no_pmtu_disc

Global switch to turn path MTU discovery off. It can also be set on a per socket basis by the applications or on a per route basis.

ip_masq_debug

Enable/disable debugging of IP masquerading.

IP fragmentation settings

ipfrag_high_trash and ipfrag_low_trash

Maximum memory used to reassemble IP fragments. When ipfrag_high_thresh bytes of memory is allocated for this purpose, the fragment handler will toss packets until ipfrag_low_thresh is reached.

ipfrag_time

Time in seconds to keep an IP fragment in memory.

TCP settings

tcp_ecn

This file controls the use of the ECN bit in the IPv4 headers, this is a new feature about Explicit Congestion Notification, but some routers and firewalls block traffic that has this bit set, so it could be necessary to echo 0 to /proc/sys/net/ipv4/tcp_ecn, if you want to talk to this sites. For more info you could read RFC2481.

tcp_retrans_collapse

Bug-to-bug compatibility with some broken printers. On retransmit, try to send larger packets to work around bugs in certain TCP stacks. Can be turned off by setting it to zero.

tcp_keepalive_probes

Number of keep alive probes TCP sends out, until it decides that the connection is broken.

Introduction to Linux

tcp_keepalive_time

How often TCP sends out keep alive messages, when keep alive is enabled. The default is 2 hours.

tcp_syn_retries

Number of times initial SYNs for a TCP connection attempt will be retransmitted. Should not be higher than 255. This is only the timeout for outgoing connections, for incoming connections the number of retransmits is defined by tcp_retries1.

tcp_sack

Enable select acknowledgments after RFC2018.

tcp_timestamps

Enable timestamps as defined in RFC1323.

tcp_stdurg

Enable the strict RFC793 interpretation of the TCP urgent pointer field. The default is to use the BSD compatible interpretation of the urgent pointer pointing to the first byte after the urgent data. The RFC793 interpretation is to have it point to the last byte of urgent data. Enabling this option may lead to interoperability problems. Disabled by default.

tcp_syncookies

Only valid when the kernel was compiled with CONFIG_SYNCOOKIES. Send out syncookies when the syn backlog queue of a socket overflows. This is to ward off the common 'syn flood attack'. Disabled by default.

Note that the concept of a socket backlog is abandoned. This means the peer may not receive reliable error messages from an over loaded server with syncookies enabled.

tcp_window_scaling

Enable window scaling as defined in RFC1323.

tcp_fin_timeout

The length of time in seconds it takes to receive a final FIN before the socket is always closed. This is strictly a violation of the TCP specification, but required to prevent denial-of-service attacks.

tcp_max_ka_probes

Indicates how many keep alive probes are sent per slow timer run. Should not be set too high to prevent bursts.

Introduction to Linux

tcp_max_syn_backlog

Length of the per socket backlog queue. Since Linux 2.2 the backlog specified in listen(2) only specifies the length of the backlog queue of already established sockets. When more connection requests arrive Linux starts to drop packets. When syncookies are enabled the packets are still answered and the maximum queue is effectively ignored.

tcp_retries1

Defines how often an answer to a TCP connection request is retransmitted before giving up.

tcp_retries2

Defines how often a TCP packet is retransmitted before giving up.

Interface specific settings

In the directory /proc/sys/net/ipv4/conf you'll find one subdirectory for each interface the system knows about and one directory calls all. Changes in the all subdirectory affect all interfaces, whereas changes in the other subdirectories affect only one interface. All directories have the same entries:

accept_redirects

This switch decides if the kernel accepts ICMP redirect messages or not. The default is 'yes' if the kernel is configured for a regular host and 'no' for a router configuration.

accept_source_route

Should source routed packages be accepted or declined. The default is dependent on the kernel configuration. It's 'yes' for routers and 'no' for hosts.

bootp_relay

~~~~~

Accept packets with source address 0.b.c.d with destinations not to this host as local ones. It is supposed that a BOOTP relay daemon will catch and forward such packets.

The default is 0, since this feature is not implemented yet (kernel version 2.2.12).

forwarding

-----

Enable or disable IP forwarding on this interface.

log\_martians

-----

## Introduction to Linux

Log packets with source addresses with no known route to kernel log.

mc\_forwarding  
-----

Do multicast routing. The kernel needs to be compiled with CONFIG\_MROUTE and a multicast routing daemon is required.

proxy\_arp  
-----

Does (1) or does not (0) perform proxy ARP.

rp\_filter  
-----

Integer value determines if a source validation should be made. 1 means yes, 0 means no. Disabled by default, but local/broadcast address spoofing is always on.

If you set this to 1 on a router that is the only connection for a network to the net, it will prevent spoofing attacks against your internal networks (external addresses can still be spoofed), without the need for additional firewall rules.

secure\_redirects  
-----

Accept ICMP redirect messages only for gateways, listed in default gateway list. Enabled by default.

shared\_media  
-----

If it is not set the kernel does not assume that different subnets on this device can communicate directly. Default setting is 'yes'.

send\_redirects  
-----

Determines whether to send ICMP redirects to other hosts.

Routing settings  
-----

The directory /proc/sys/net/ipv4/route contains several file to control routing issues.

error\_burst and error\_cost  
-----

These parameters are used to limit the warning messages written to the kernel log from the routing code. The higher the error\_cost factor is, the fewer messages will be written. Error\_burst controls when messages will be dropped. The default settings limit warning messages to one every five seconds.

flush  
-----

Writing to this file results in a flush of the routing cache.

gc\_elastic, gc\_interval, gc\_min\_interval, gc\_tresh, gc\_timeout



## Introduction to Linux

-----  
Values to control the frequency and behavior of the garbage collection algorithm for the routing cache.

max\_size  
-----

Maximum size of the routing cache. Old entries will be purged once the cache reached has this size.

max\_delay, min\_delay  
-----

Delays for flushing the routing cache.

redirect\_load, redirect\_number  
-----

Factors which determine if more ICPM redirects should be sent to a specific host. No redirects will be sent once the load limit or the maximum number of redirects has been reached.

redirect\_silence  
-----

Timeout for redirects. After this period redirects will be sent again, even if this has been stopped, because the load or number limit has been reached.

Network Neighbor handling  
-----

Settings about how to handle connections with direct neighbors (nodes attached to the same link) can be found in the directory /proc/sys/net/ipv4/neigh.

As we saw it in the conf directory, there is a default subdirectory which holds the default values, and one directory for each interface. The contents of the directories are identical, with the single exception that the default settings contain additional options to set garbage collection parameters.

In the interface directories you'll find the following entries:

base\_reachable\_time  
-----

A base value used for computing the random reachable time value as specified in RFC2461.

retrans\_time  
-----

The time, expressed in jiffies (1/100 sec), between retransmitted Neighbor Solicitation messages. Used for address resolution and to determine if a neighbor is unreachable.

unres\_qlen  
-----

Maximum queue length for a pending arp request - the number of packets which are accepted from other layers while the ARP address is still resolved.

anycast\_delay

## Introduction to Linux

-----  
Maximum for random delay of answers to neighbor solicitation messages in jiffies (1/100 sec). Not yet implemented (Linux does not have anycast support yet).

ucast\_solicit  
-----

Maximum number of retries for unicast solicitation.

mcast\_solicit  
-----

Maximum number of retries for multicast solicitation.

delay\_first\_probe\_time  
-----

Delay for the first time probe if the neighbor is reachable. (see gc\_stale\_time)

locktime  
-----

An ARP/neighbor entry is only replaced with a new one if the old is at least locktime old. This prevents ARP cache thrashing.

proxy\_delay  
-----

Maximum time (real time is random [0..proxytime]) before answering to an ARP request for which we have an proxy ARP entry. In some cases, this is used to prevent network flooding.

proxy\_qlen  
-----

Maximum queue length of the delayed proxy arp timer. (see proxy\_delay).

app\_solcit  
-----

Determines the number of requests to send to the user level ARP daemon. Use 0 to turn off.

gc\_stale\_time  
-----

Determines how often to check for stale ARP entries. After an ARP entry is stale it will be resolved again (which is useful when an IP address migrates to another machine). When ucast\_solicit is greater than 0 it first tries to send an ARP packet directly to the known host. When that fails and mcast\_solicit is greater than 0, an ARP request is broadcasted.

2.9 Appletalk  
-----

The /proc/sys/net/appletalk directory holds the Appletalk configuration data when Appletalk is loaded. The configurable parameters are:

aarp-expiry-time

## Introduction to Linux

-----  
The amount of time we keep an ARP entry before expiring it. Used to age out old hosts.

aarp-resolve-time  
-----

The amount of time we will spend trying to resolve an Appletalk address.

aarp-retransmit-limit  
-----

The number of times we will retransmit a query before giving up.

aarp-tick-time  
-----

Controls the rate at which expires are checked.

The directory `/proc/net/appletalk` holds the list of active Appletalk sockets on a machine.

The fields indicate the DDP type, the local address (in network:node format) the remote address, the size of the transmit pending queue, the size of the received queue (bytes waiting for applications to read) the state and the uid owning the socket.

`/proc/net/atalk_iface` lists all the interfaces configured for appletalk. It shows the name of the interface, its Appletalk address, the network range on that address (or network number for phase 1 networks), and the status of the interface.

`/proc/net/atalk_route` lists each known network route. It lists the target (network) that the route leads to, the router (may be directly connected), the route flags, and the device the route is using.

### 2.10 IPX -----

The IPX protocol has no tunable values in `proc/sys/net`.

The IPX protocol does, however, provide `proc/net/ipx`. This lists each IPX socket giving the local and remote addresses in Novell format (that is network:node:port). In accordance with the strange Novell tradition, everything but the port is in hex. `Not_Connected` is displayed for sockets that are not tied to a specific remote address. The Tx and Rx queue sizes indicate the number of bytes pending for transmission and reception. The state indicates the state the socket is in and the uid is the owning uid of the socket.

The `/proc/net/ipx_interface` file lists all IPX interfaces. For each interface it gives the network number, the node number, and indicates if the network is the primary network. It also indicates which device it is bound to (or Internal for internal networks) and the Frame Type if appropriate. Linux supports 802.3, 802.2, 802.2 SNAP and DIX (Blue Book) ethernet framing for IPX.

The `/proc/net/ipx_route` table holds a list of IPX routes. For each route it gives the destination network, the router node (or Directly) and the network address of the router (or Connected) for internal networks.

## Introduction to Linux

---

### Summary

---

Certain aspects of kernel behavior can be modified at runtime, without the need to recompile the kernel, or even to reboot the system. The files in the /proc/sys tree can not only be read, but also modified. You can use the echo command to write value into these files, thereby changing the default settings of the kernel.

---

# Glossary

This section contains an alphabetical overview of commands discussed in this document.

## A

### *a2ps*

Format files for printing on a PostScript printer, see [Section 8.1.2](#).

### *acroread*

PDF viewer, see [Section 8.1.2.2](#).

### *adduser*

Create a new user or update default new user information.

### *alias*

Create a shell alias for a command.

### *anacron*

Execute commands periodically, does not assume continuously running machine.

### *apropos*

Search the whatis database for strings, see [Section 2.3.3.2](#).

### *apt-get*

APT package handling utility, see [Section 7.6.3.2](#).

### *aspell*

Spell checker.

### *at, atq, atrm*

Queue, examine or delete jobs for later execution, see [Section 4.1.2.2](#) and [Section 4.4.3](#).

### *aumix*

Adjust audio mixer, see [Section 7.4.3.3](#).

### *(g)awk*

Pattern scanning and processing language.

## B

### *bash*

Bourne Again SHell, see [Section 3.2.3.2](#) and [Section 7.2.5](#).

### *batch*

Queue, examine or delete jobs for later execution, see [Section 4.1.2.2](#).

### *bg*

Run a job in the background, see [Section 4.1.2.1](#).

### *bitmap*

Bitmap editor and converter utilities for the X window System.

### *bzip2*

A block-sorting file compressor, see [Section 9.1.1.3](#).

## C

### *cat*

Concatenate files and print to standard output, see [Section 2.2](#) and [Section 3.2.4](#).

### *cd*

Change directory, see [Section 2.2](#).

***cdp/cdplay***

An interactive text-mode program for controlling and playing audio CD Roms under Linux, see [Section 7.4.3.1](#).

***cdparanoia***

An audio CD reading utility which includes extra data verification features, see [Section 7.4.3.1](#).

***cdrecord***

Record a CD-R, see [Section 9.2.2](#).

***chattr***

Change file attributes.

***chgrp***

Change group ownership, see [Section 3.4.2.3](#).

***chkconfig***

Update or query run level information for system services, see [Section 4.2.5.1](#).

***chmod***

Change file access permissions, see [Section 3.4.1](#), [Section 3.4.2.1](#) and [Section 3.4.2.4](#).

***chown***

Change file owner and group, see [Section 3.4.2.3](#).

***compress***

Compress files.

***cp***

Copy files and directories, see [Section 3.3.2](#).

***crontab***

Maintain crontab files, see [Section 4.4.4](#).

***csch***

Open a C shell, see [Section 3.2.3.2](#).

***cut***

Remove sections from each line of file(s), see [Section 7.2.5.2](#).

## **D**

***date***

Print or set system date and time.

***dd***

Convert and copy a file (disk dump), see [Section 9.2.1.2](#).

***df***

Report file system disk usage, see [Section 3.1.2.3](#).

***dhcpcd***

DHCP client daemon, see [Section 10.2.8](#).

***diff***

Find differences between two files.

***dig***

Send domain name query packets to name servers, see [Section 10.1.2.6](#).

***dmesg***

Print or control the kernel ring buffer.

***du***

Estimate file space usage.

**E**

- echo* Display a line of text, see [Section 3.2.1](#).
- ediff* Diff to English translator.
- egrep* Extended grep.
- eject* Unmount and eject removable media, see [Section 7.6.5.2](#).
- emacs* Start the Emacs editor, see [Section 6.1.2.2](#).
- exec* Invoke subprocess(es).
- exit* Exit current shell, see [Section 2.2](#).
- export* Add function(s) to the shell environment, see [Section 3.2.1](#), [Section 7.2.1.2](#) and [Section 7.2.4.2](#).

**F**

- fax2ps* Convert a TIFF facsimile to PostScript, see [Section 8.1.2](#).
- fdformat* Format floppy disk, see [Section 9.2.1.1](#).
- fdisk* Partition table manipulator for Linux, see [Section 3.1.2.2](#).
- fetchmail* Fetch mail from a POP, IMAP, ETRN or ODMR-capable server, see [Section 10.2.2.3](#).
- fg* Bring a job in the foreground, see [Section 4.1.2.1](#).
- file* Determine file type, see [Section 3.3.1.2](#).
- find* Find files, see [Section 3.3.3.3](#).
- formail* Mail (re)formatter, see [Section 10.2.2.3](#).
- fortune* Print a random, hopefully interesting adage.
- ftp* Transfer files (unsafe unless anonymous account is used!)services, see [Section 10.2.4.2](#).

**G**

- galeon* Graphical web browser.
- gdm* Gnome Display Manager, see [Section 4.2.4](#).
- (min/a)getty*

Control console devices.

***gimp***

Image manipulation program.

***grep***

Print lines matching a pattern, see [Section 3.3.3.4](#) and [Section 5.1.3.1](#).

***groff***

Emulate nroff command with groff, see [Section 8.1.2](#).

***grub***

The grub shell, see [Section 4.2.3](#) and [Section 7.6.4](#).

***gv***

A PostScript and PDF viewer, see [Section 8.1.2.2](#).

***gzip***

Compress or expand files, see [Section 9.1.1.3](#).

## H

***halt***

Stop the system, see [Section 4.2.6](#).

***head***

Output the first part of files, see [Section 3.3.4.3](#).

***help***

Display help on a shell built-in command.

***host***

DNS lookup utility, see [Section 10.1.2.6](#).

***httpd***

Apache hypertext transfer protocol server, see [Section 10.2.3.1](#).

## I

***id***

Print real and effective UIDs and GIDs, see [Section 3.4.1](#).

***ifconfig***

Configure network interface or show configuration, see [Section 10.1.2.3](#).

***info***

Read Info documents, see [Section 2.3.3.1](#).

***init***

Process control initialization, see [Section 4.1.5.1](#), [Section 4.2.4](#) and [Section 4.2.5](#).

***iostat***

Display I/O statistics, see [Section 4.3.5.4](#).

***ip***

Display/change network interface status, see [Section 10.1.2.3](#).

***ipchains***

IP firewall administration, see [Section 10.4.4.2](#).

***iptables***

IP packet filter administration, see [Section 10.4.4.2](#).

## J

***jar***



Java archive tool, see [Section 9.1.1.4](#).

**jobs**

List backgrounded tasks.

**K**

**kd**

Desktop manager for KDE, see [Section 4.2.4](#).

**kill(all)**

Terminate process(es), see [Section 4.1.2.1](#).

**ksh**

Open a Korn shell, see [Section 3.2.3.2](#).

**L**

**ldapmodify**

Modify an LDAP entry, see [Section 10.2.9.3](#).

**ldapsearch**

LDAP search tool, see [Section 10.2.9.3](#).

**less**

**more** with features, see [Section 3.3.4.2](#).

**lilo**

Linux boot loader, see [Section 4.2](#).

**links**

Text mode WWW browser, see [Section 10.2.3.2](#).

**ln**

Make links between files, see [Section 3.3.5](#).

**loadkeys**

Load keyboard translation tables, see [Section 7.5.1](#).

**locate**

Find files, see [Section 3.3.3.3](#) and [Section 4.4.4](#).

**logout**

Close current shell, see [Section 2.1.3](#).

**lp**

Send requests to the LP print service, see [Section 8.1](#).

**lpc**

Line printer control program, see [Section 8.1](#).

**lpq**

Print spool queue examination program, see [Section 8.1](#).

**lpr**

Offline print, see [Section 8.1](#).

**lprm**

Remove print requests, see [Section 8.1](#).

**ls**

List directory content, see [Section 2.2](#), [Section 3.1.1.2](#) and [Section 3.3.1.1](#).

**lynx**

Text mode WWW browser, see [Section 10.2.3.2](#).

**M*****mail***

Send and receive mail, see [Section 10.2.2.3](#).

***man***

Read man pages, see [Section 2.3.2](#).

***mcopy***

Copy MSDOS files to/from Unix.

***mdir***

Display an MSDOS directory.

***memusage***

Display memory usage, see [Section 4.3.5.3](#).

***memusagestat***

Display memory usage statistics, see [Section 4.3.5.3](#).

***mesg***

Control write access to your terminal, see [Section 4.1.6](#).

***mformat***

Add an MSDOS file system to a low-level formatted floppy disk, see [Section 9.2.1.1](#).

***mkbootdisk***

Creates a stand-alone boot floppy for the running system.

***mkdir***

Create directory, see [Section 3.3.2](#).

***mkisofs***

Create a hybrid ISO9660 filesystem, see [Section 9.2.2](#).

***more***

Filter for displaying text one screen at the time, see [Section 3.3.4.2](#).

***mount***

Mount a file system or display information about mounted file systems, see [Section 7.6.5.1](#).

***mozilla***

Web browser, see [Section 10.2.3.2](#).

***mt***

Control magnetic tape drive operation.

***mtr***

Network diagnostic tool.

***mv***

Rename files, [Section 3.3.2](#).

**N*****named***

Internet domain name server, see [Section 10.2.7](#).

***ncftp***

Browser program for ftp services (insecure!), see [Section 10.2.4.2](#).

***netstat***

Print network connections, routing tables, interface statistics, masquerade connections, and multi-cast memberships, see [Section 10.1.2.5](#) and [Section 10.4.2](#).

***nfsstat***

Print statistics about networked file systems.

***nice***

Run a program with modified scheduling priority, see [Section 4.3.5.1](#).

*ntsysv*

Simple interface for configuring run levels, see [Section 4.2.5.1](#).

## P

*passwd*

Change password, see [Section 2.2](#) and [Section 4.1.6](#).

*pdf2ps*

Ghostscript PDF to PostScript translator, see [Section 8.1.2](#).

*perl*

Practical Extraction and Report Language.

*pg*

Page through text output, see [Section 3.3.4.2](#).

*ping*

Send echo request to a host, see [Section 10.1.2.6](#).

*pr*

Convert text files for printing.

*printenv*

Print all or part of environment, see [Section 7.2.1](#).

*procmail*

Autonomous mail processor, see [Section 10.2.2.3](#).

*ps*

Report process status, see [Section 4.1.4](#) and [Section 4.3.5.4](#).

*pstree*

Display a tree of processes, see [Section 4.1.4](#).

*pwd*

Print present working directory, see [Section 2.2](#).

## Q

*quota*

Display disk usage and limits, see [Section 3.2.3.3](#).

## R

*rcp*

Remote copy (unsafe!)

*reboot*

Stop the system, see [Section 4.2.6](#).

*renice*

Alter priority of a running process, see [Section 4.3.5.1](#).

*rlogin*

Remote login (telnet, insecure!), see [Section 10.3.2](#) and [Section 10.3.3.2](#).

*rm*

Remove a file, see [Section 3.3.2](#).

*rmdir*

Remove a directory, see [Section 3.3.2.2](#).

*roff*

A survey of the roff typesetting system, see [Section 8.1.2](#).

***rpm***

RPM Package Manager, see [Section 7.6.2.1](#).

***rsh***

Remote shell (insecure!), see [Section 10.3.2](#).

**S**

***scp***

Secure remote copy, see [Section 10.3.4.4](#).

***screen***

Screen manager with VT100 emulation, see [Section 4.1.2.1](#).

***set***

Display, set or change variable.

***setterm***

Set terminal attributes.

***sftp***

Secure (encrypted) ftp, see [Section 10.2.4.2](#) and [Section 10.3.4.4](#).

***sh***

Open a standard shell, see [Section 3.2.3.2](#).

***shutdown***

Bring the system down, see [Section 4.2.6](#).

***sleep***

Wait for a given period, see [Section 4.4.1](#).

***slocate***

Security Enhanced version of the GNU Locate, see [Section 3.3.3.3](#).

***slrnn***

text mode Usenet client, see [Section 10.2.6](#).

***snort***

Network intrusion detection tool.

***sort***

Sort lines of text files, see [Section 5.1.3.2](#).

***ssh***

Secure shell, see [Section 10.3.4](#).

***ssh-keygen***

Authentication key generation, management and conversion, see [Section 10.3.4.5](#).

***stty***

Change and print terminal line settings.

***su***

Switch user, see [Section 3.2.1](#), [Section 7.6.3.2](#) and [Section 10.4.6](#).

**T**

***tac***

Concatenate and print files in reverse, see [cat](#).

***tail***

Output the last part of files, see [Section 3.3.4.3](#).

***talk***

Talk to a user.

***tar***

Archiving utility, see [Section 9.1.1.1](#).

***t***

- t***
  - t*** Open a Turbo C shell, see [Section 3.2.3.2](#).
  - telnet*** User interface to the TELNET protocol (insecure!), see [Section 10.3.2](#).
  - tex*** Text formatting and typesetting, see [Section 8.1.2](#).
  - time*** Time a simple command or give resource usage, see [Section 4.3.2](#).
  - tin*** News reading program, see [Section 10.2.6](#).
  - top*** Display top CPU processes, see [Section 4.1.4](#), [Section 4.3.5.3](#) and [Section 4.3.5.4](#).
  - touch*** Change file timestamps, see [Section 7.1.2](#).
  - traceroute*** Print the route packets take to network host, see [Section 10.1.2.6](#).
  - tripwire*** A file integrity checker for UNIX systems, see [Section 10.4.5](#).
  - troff*** Format documents, see [Section 8.1.2](#).
  - twm*** Tab Window Manager for the X Window System.

**U**

- ulimit*** Controll resources, see [Section 7.1.2.5](#).
- umask*** Set user file creation mask, see [Section 3.4.2.2](#).
- umount*** Unmount a file system.
- uncompress*** Decompress compressed files.
- uniq*** Remove duplicate lines from a sorted file, see [Section 5.1.3.2](#).
- update*** Kernel daemon to flush dirty buffers back to disk.
- uptime*** Display system uptime and average load, see [Section 4.1.4](#) and [Section 4.3.5.2](#).
- userdel*** Delete a user account and related files.

**V**

- vi(m)*** Start the vi (improved) editor, see [Section 6.1.2.3](#).
- vimtutor*** The Vim tutor.
- vmstat*** Report virtual memory statistics, see [Section 4.3.5.4](#).

**W***w*

Show who is logged on and what they are doing.

*wall*Send a message to everybody's terminal, see [Section 4.1.6](#).*wc*Print the number of bytes, words and lines in files, see [Section 3.2.1](#).*which*Shows the full path of (shell) commands, see [Section 3.2.1](#) and [Section 3.3.3.2](#).*who*Show who is logged on, see [Section 4.1.6](#).*who am i*

Print effective user ID.

*whois*Query a whois or nickname database, see [Section 10.1.2.6](#).*write*Send a message to another user, see [Section 4.1.6](#).**X***xauth*

X authority file utility.

*xcdroast*Graphical front end to cdrecord, see [Section 9.2.2](#).*xclock*

Analog/digital clock for X.

*xconsole*

Monitor system console messages with X.

*xdm*X Display Manager with support for XDMCP, host chooser, see [Section 4.2.4](#) and [Section 7.3.2](#).*xdvi*DVI viewer, see [Section 8.1.2.2](#).*xfs*

X font server.

*xhost*Server access control program for X, see [Section 10.3.3.2](#)*xinetd*The extended Internet services daemon, see [Section 10.2.1.2](#).*xload*System load average display for X, see [Section 4.3.5.6](#).*xlsfonts*

Server font list displayer for X.

*xmms*Audio player for X, see [Section 7.4.3.2.1](#).*xpdf*PDF viewer, see [Section 8.1.2.2](#).*xterm*

Terminal emulator for X.

## Z

*zcat*

Compress or expand files.

*zgrep*

Search possibly compressed files for a regular expression.

*zmore*

Filter for viewing compressed text.